



*çevre dostu  
üretim*

*green  
products*



## **İÇİNDEKİLER / İNDEX**

1- ALFA ROMEO	.....	1 - 2
2- ASIA MOTOR	.....	3 - 4
3- AUDI	.....	5 - 10
4- CHEVROLET	.....	11 - 14
5- CHRYSLER	.....	15 - 16
6- CITROEN	.....	17 - 32
7- DACIA	.....	33 - 36
8- DAEWOO	.....	37 - 42
9- DAIHATSU	.....	43 - 44
10- FIAT	.....	45 - 84
11- FORD	.....	85 - 96
12- HONDA	.....	97 - 98
13- HYUNDAI	.....	99 - 110
14- IVECO	.....	111 - 116
15- JOHN DEERE	.....	117 - 136
16- KIA	.....	137 - 148
17- LADA	.....	149 - 154
18- LAND ROVER	.....	155 - 156
19- MAHINDRA	.....	157 - 158
20- MAZDA	.....	159 - 170
21- MITSUBISHI	.....	171 - 176
22- NISSAN	.....	177 - 182
23- OPEL	.....	183 - 200
24- PEUGEOT	.....	201 - 228
25- PROTON	.....	229 - 232
26- RENAULT	.....	233 - 282
27- SAVIEM	.....	283 - 284
28- SKODA	.....	285 - 286
29- TOYOTA	.....	287 - 290
30- VOLVO	.....	291 - 302
31- VOLKSWAGEN	.....	303 - 316
32- VOLGA	.....	317 - 318
32- IKCO	.....	319 - 320

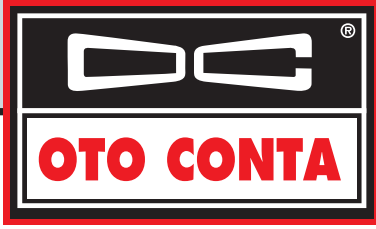

## Silindir Kapak Contaları:

Silindir kapak contası, silindir kafası ve blok arasına yerleştirilmiştir. Isı, mekanik ve kimyasal etkenlere direnç gösterir. Conta çeşitli sıcaklıklar arasında kusursuz sızdırmazlık gerektirir. Contanın montajı esnasında contaya herhangi bir zarar verilmemeli ve tork anahtarı ile fabrikanın önerdiği derecede sıkma işlemi gerçekleştirilmelidir.

## Cylinder Head Gasket:

Situated between the cylinder head and the block, the cylinder head gasket is punished by increasingly greater stresses: thermal, mechanical and chemical. It must ensure a flawless seal across a wide range of temperatures, despite being tightened with a limited torque setting so as not to damage or weaken the cylinder head and at the same time withstand the inevitable movements between cylinder head and block.

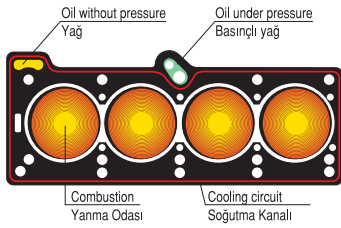

	Sıcaklık / Temperature (°C)	Basınç / Pressure (bars)
Sıkıştırılmış gazlar / Combustion gases	> 1000	70 - 160 (TDI)
Yağ / Oil	-30 - 150	0 - 7
Su (antifriz) / Water (cooling liquid)	-30 - 110	0.5 - 1.5

## Dizel ve Turbo Dizel Araçlar:

Dizel ve turbo dizel motorlarda yüksek sıkıştırma oranlarından dolayı, conta malzemesi son derece önem taşımaktadır. Pistonlar motor bloğunun üstüne kadar geçer ve pistonlar daha düz ve subaplar pistonlarla sürtünmeyecek şekilde tasarlanmıştır. Bu sebepten ötürü conta kalınlıkları resimde görüldüğü gibi son derece önemlidir.

## Benzinli Araçlar:

Dizel araçlara göre sıkıştırma oranları ve torklar daha düşüktür. Fakat yine dizel araçlarda olduğu gibi basınca ve yüksek ısıya karşı sızdırmazlığı koruyacak malzemeler kullanılmalıdır. Günümüzde otomobil üreticileri sızdırmazlığı sağlamak amacıyla motorlarda Multi Layer Steel (MLS) contalar kullanmaktadır.

## Diesel and Turbo Diesel Vehicles :

Gasket material is of utmost importance in diesel and turbo diesel engines because of the high compressing ratios. Pistons pass beyond the engine block and pistons are designed as more flat and valves are designed in a way that they will not have friction with pistons. For this reason, as seen in the picture, gasket thicknesses are very important.

## Gasoline Vehicles :

Compression ratios and torques are less with respect to diesel vehicles. But still materials that will maintain sealing against compression must be used. Nowadays car drivers use Multi Layer Steel (MLS) gaskets in engines in order to provide sealing.

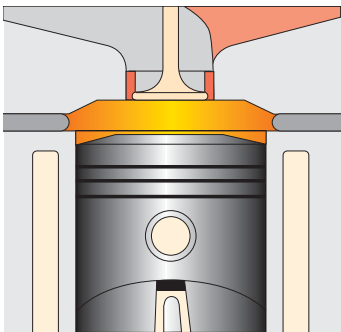
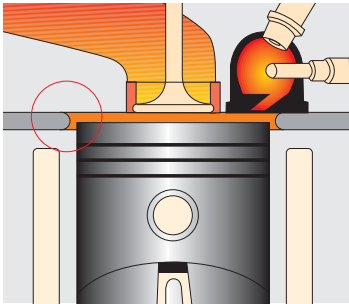



## Multi Layer Steel (MLS) Kapak Contaları

Birçok araç üreticisi artık orijinal donatım olarak Multi Layer Steel (çok katlı çelik) silindir kapak contalarını geliştirmiştir.

Bu ürünler, daha yüksek silindir basınçları ve modern motorlarda, ısı ve basınçla başa çıkabilmek amacıyla tasarlanmıştır. **OTO CONTA**, gelişmiş tasarım sızdırmazlık materyalleri kullanarak, uygulamaları karşılayabilmek için en geniş Multi Layer Steel conta yelpazesini geliştirmiştir.

**OTO CONTA** MLS Özel Kapak Contaları çelik üç katmandan oluşmaktadır. **OTO CONTA**, basınca karşı doğal dayanımına ek güç olarak çelik kullanmaktadır.



## Multi Layer Steel (MLS) Head Gaskets.

*Many vehicle manufacturers are now fitting Multi Layer steel cylinder head gaskets, as original equipment.*

*These are designed to cope with higher cylinder pressures and thermal stresses in modern engines. **OTO CONTA** has developed the widest range of Multi Layer steel gaskets to meet the demand for applications using the latest design sealing system.*

***OTO CONTA** MLS Custom Head Gaskets are comprised of three layers of stainless steel. **OTO CONTA** use stainless steel for added strength it's ability to rebound and it's natural resistance to corrosion.*









## AMBALAJ / PACKAGE



# KATALOG KULLANMA BİLGİLERİ

## INSTRUCTION FOR USE OF CATALOGUE

Kalınlık - Kertik - Delik  
Thick - Thickness - Hole - Notch

Ltr		MODEL	PS/KW	ENGINE/MOTOR		
1,9		4 CYL ø83				
1905	BOXER Bus D	03/88-->	70 PS / 51 KW	XUD9A (DJY)	<b>41204002</b>	
	BOXER D		68 PS / 50 KW	XUD9A (D9B)	0197.H5	<b>41204009</b>
	EXPERT D			XUD9AU (D8C)		0209.S5
	J5 Bus D				<b>41204003</b>	1,36 mm 1 
	J5 D				0197.H4	<b>41204008</b>
	PARTNER D					0209.S6
	306 D					1,40 mm 2 
	306 SLD					<b>41204007</b>
	405 D					0209.S7
						1,44 mm 3 
						<b>41204006</b>
						0209.S8
						1,48 mm 4 
						<b>41204005</b>
						0209.S9
						1,53 mm 5 
						ø 84

▲ : İçerikte Bulunmamaktadır...

▲ : Not included in the set

▲ : Non inclus dans la pochette

00: Motor Takım Keçesiz ve Subap Lastiksiz

00: Gasket Set Without oil seals Without Valve Stem Seal

01: Motor Takım Keçesiz - Subap Lastikli

01: Gasket set With Valve Stem Seal Without Oil Seals















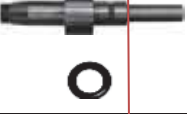

02: Motor Full Takım Keçeli ve Subap Lastikli

02: Gasket Full Set With oil seals and Valve Stem Seals

Sola Sarımlı  
Left-hand twist

Sağa Sarımlı  
Right-hand twist

Değişken Sarımlı  
Alternate twist

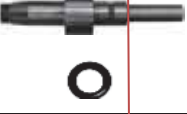
Subap Kapak Valve Cover Gasket Zylinderkopfhaube Couvre-culbut.	Karter Oil Pan Ölwanne Carter d'huile	Emme Manifold Intake Manifold Ansaug Admission	Egzoz Manifold Exhaust Manifold Auspuffkrümmer Collecteur D'echappement	Eksoz Boğaz Exhaust Pipe Auspuff Kehle	Supap Keçesi Valve Stem Seal Ventilschaft Queue de soupape	
						
 41203525 0249.46 0249.91	 41203013 0304.34  41203014 93501565	 41203116x2 0348.99  41203018x2 91508659  41203021 0348.JO	 41205019 1721.01 7810024000  41203120x2 0349.47 93010402		 40107027x8 0956.22 8x10,8/14,2x10	 21201011x2 35x50x8 <b>WD</b> 21201019 42x62x8 <b>RD</b> 21201040 90x110x7 <b>LD</b>

■ : Delik - Çentik

■ : Hole - Notch

■ : Trou - Entaille

NOT: Katalogdaki Orijinal Kodlar Referans Amacıyla Kullanılmıştır.Lütfen Oto Conta Kodlarını Kullanınız.  
Original codes used for reference only.Please use OTO CONTA codes for orders.



# ALFA ROMEO

00

Silindir Kapak  
Cylinder Head

01



Zylinderkopf

02



Joint de culasse

03



04

**Ltr** **MODEL** **PS/KW** **ENGINE/MOTOR**

Ltr	MODEL	PS/KW	ENGINE/MOTOR		
1,8 1796	4 CYL ø80,5 159 03/07-->11/11	103 PS / 140 KW	939 A4.000		 <b>41417005</b> 71744395 1,20mm FIBER / FIBRE ø82
1,9 1910	4 CYL ø82 147 JTD 147 JTD 156 JTD 156 JTD 04/01--> 04/01--> 10/00-->05/01 05/01-->09/05	115 PS / 85 KW 101 PS / 74 KW 110 PS / 81 KW 115 PS / 85 KW	937 A2.000 182 B9.000 AR 37101 937 A2.000	<b>42427802</b> 60 816 452  <b>42427803</b> 71716051  <b>42427704</b> 71730213	 <b>42427805</b> 60816233 0,82mm ø83 <b>42427806</b> 60816234 0,92mm 1 ø83 <b>42427807</b> 60816235 1,02mm 2 MLS ø83
1,9 1929	4 CYL ø82,6 145 TD 146 TD 10/94-->02/99 10/94-->02/99	90 PS / 66 KW 90 PS / 66 KW	AR 33601 AR 67501		 <b>42426605</b> 46451596 1,90mm ø83,5
2,00 1995	4 CYL ø84 164 TURBO ( DOCH ) 10/87-->09/98	174 PS / 128 KW	AR 06476	<b>42424001</b> 60777803	 <b>42424005</b> 7660966 1,80mm ø85

▲ : İçerikte Bulunmamaktadır...

▲ : Not included in the set

▲ : Non inclus dans la pochette

00: Motor Takım Keçesiz ve Subap Lastiksiz

00: Gasket Set Without oil seals Without Valve Stem Seal











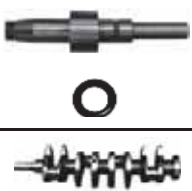





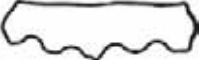

01: Motor Takım Keçesiz - Subap Lastikli

01: Gasket set With Valve Stem Seal Without Oil Seals

02: Motor Full Takım Keçeli ve Subap Lastikli

02: Gasket Full Set With oil seals and Valve Stem Seals

001

Subap Kapak Valve Cover Gasket Zylinderkopfhaube Couvre-culbut.	Karter Oil Pan Ölwanne Carter d'huile	Emme Manifold Intake Manifold Ansaug Admission	Egzoz Manifold Exhaust Manifold Auspuffkrümmer Collecteur D'echappement	Eksoz Boğaz Exhaust Pipe Auspuff Kehle	Supap Keçesi Valve Stem Seal Ventilschaft Queue de soupape	
						
						<b>21208003</b> 30x42x7 RD
<b>42427825</b> 55197598		<b>42427820</b> 71738458	<b>42427821</b> 46467747		<b>40107027x8</b> 60504110 8x10,8/14,2x10	<b>21201100</b> 31x41x7 RD
						
<b>40330034x2</b> 7660565	<b>42424013</b> 7646248	<b>40330019</b> 7700197	<b>40308020</b> 4368925		<b>40107027x8</b> 60504110 8x10,8/14,2x10	
						
<b>40331035x2</b> 7684064						

■ : Delik - Çentik

■ : Hole - Notch

■ : Trou - Entaille

NOT: Katalogdaki Orijinal Kodlar Referans Amacıyla Kullanılmıştır.Lütfen Oto Conta Kodlarını Kullanınız.  
Original codes used for reference only.Please use OTO CONTA codes for orders.



## ASIA MOTORS

00



Silindir Kapak

Cylinder Head

01



Zylinderkopf

02



Joint de culasse

03



04



Ltr	MODEL	PS/KW	ENGINE/MOTOR		
1,8 1781	4 CYL ø86 ROCSTA 06/93-->12/999	77 PS / 57 KW	F804 FE		 <b>41420305</b> F202-10-271 1,40mm <b>41420306</b> F202-10-271 1,80mm <b>ø87,5</b>
2,2 2184	4 CYL ø86 ROCSTA DIESEL 11/89 -->12/99 06/93-->12/99	72PS / 53KW 61PS / 45 KW	R2	<b>41410000</b> 8AG7-10-271	 <b>41410005</b> R201-10-271A <b>ø87,5</b>
2,7 2701	4 CYL ø92 HI-TOPIC TOPIC DIESEL 01/98-->12/99 06/93-->12/99	69 PS / 51 KW 75 PS / 55 KW		<b>41480000</b> AGS-T-725M	 <b>41480005</b> 0527-10-271A <b>ø97</b>

▲ : İçerikte Bulunmamaktadır...

▲ : Not included in the set

▲ : Non inclus dans la pochette

00: Motor Takım Keçesiz ve Subap Lastiksiz

00: Gasket Set Without oil seals Without Valve Stem Seal

















01: Motor Takım Keçesiz - Subap Lastikli

01: Gasket set With Valve Stem Seal Without Oil Seals

02: Motor Full Takım Keçeli ve Subap Lastikli

02: Gasket Full Set With oil seals and Valve Stem Seals

003

Subap Kapak Valve Cover Gasket Zylinderkopfhaube Couvre-culbut.	Karter Oil Pan Ölwanne Carter d'huile	Emme Manifold Intake Manifold Ansaug Admission	Egzoz Manifold Exhaust Manifold Auspuffkrümmer Collecteur D'echappement	Eksoz Boğaz Exhaust Pipe Auspuff Kehle	Supap Keçesi Valve Stem Seal Ventilschaft Queue de soupape	
						
						
41410025 RF01-10-235	41410013 F80110-431	41410019 RF0113-111	41410020 RF01-13-462			
						
41480025 1456-10-235	41480013 1363-89-104	41480019x4 0636-13-111	41480021x4 0750-13-461 0750-13-461A			

■ : Delik - Çentik

■ : Hole - Notch

■ : Trou - Entaille

NOT: Katalogdaki Orijinal Kodlar Referans Amacıyla Kullanılmıştır.Lütfen Oto Conta Kodlarını Kullanınız.  
Original codes used for reference only.Please use OTO CONTA codes for orders.



AUDI

00



01



02



03



04



Silindir Kapak  
Cylinder Head  
Zylinderkopf  
Joint de culasse



Ltr	MODEL	PS/KW	ENGINE/MOTOR		
1,4 1390	4 CYL ø76,5 A2 02/00-->08/05	75 PS / 55 KW	AUA BBY	41405303	 41405305 036 103 383 AL MLS ø77,5
1,6 1588	4 CYL ø79,5 80 80 COUPE 08/78-->07/86 09/73-->07/86	75 PS / 55 KW 100 PS / 74 KW 75 PS / 55 KW	WW WZ XX YG YH YN	41401002 049 198 001 C 41401003 049 198 012 H 41401004 037 198 011 C	 41401005 049 103 383 K 1,60mm ø81
1,6 1595	4 CYL ø79,5 80 80 8192242682->	110 PS / 81 KW 70 PS / 51 KW	YP YS YT YY YZ	41401002 049 198 001 C 41401003 049 198 012 H 41401004 037 198 011 C	 41401005 049 103 383 K 1,60mm ø81
1,6 1588	4 CYL ø79,5 80 8192242683->	110 PS / 81 KW 70 PS / 51 KW	YP YS YT YY YZ	41401002 049 198 001 C 41401003 049 198 012 H 41401004 037 198 011 C	 41401005 049 103 383 K 1,60mm ø81
1,6 1595	4 CYL ø81 80 08 /90-->10/91 09/91-->12/94 06/93-->01/96	102 PS / 75 KW 71 PS / 52 KW 101 PS / 74 KW	ABB ABM ADA DT JU RN PP RN		 41408005 026 103 383P 026 103 383L 026 103 383M 026 103 383N 026 103 383K 1,75mm ø83

▲ : İçerikte Bulunmamaktadır...

▲ : Not included in the set

▲ : Non inclus dans la pochette

00: Motor Takım Keçesiz ve Subap Lastiksiz

00: Gasket Set Without oil seals Without Valve Stem Seal











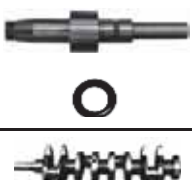















01: Motor Takım Keçesiz - Subap Lastikli

01: Gasket set With Valve Stem Seal Without Oil Seals

02: Motor Full Takım Keçeli ve Subap Lastikli

02: Gasket Full Set With oil seals and Valve Stem Seals

001

Subap Kapak Valve Cover Gasket Zylinderkopfhaube Couvre-culbut.	Karter Oil Pan Ölwanne Carter d'huile	Emme Manifold Intake Manifold Ansaug Admission	Egzoz Manifold Exhaust Manifold Auspuffkrümmer Collecteur D'echappement	Eksoz Boğaz Exhaust Pipe Auspuff Kehle	Supap Keçesi Valve Stem Seal Ventilschaft Queue de soupape	
						
<b>42427465</b>	<b>42427465</b>	<b>41405319x4</b> 036 129 717 E	<b>41405321</b> 036 253 039 F		<b>42427426x16</b> 036 109 675 A	<b>21204029x2</b> 27x42x8 RD
						<b>21201075x3</b> 32x47x10 W
<b>41401034</b> 026 198 025 A	<b>41401013</b> 028 103 609 A	<b>41401019</b> 026 129 717 D	<b>41401021x4</b> 026 129 589 A 056 129 589 B	<b>41408017</b> 841 253 115 B	<b>40107027x8</b> 026 109 675 <b>8x10,8/14,2x10</b>	<b>21204504</b> 85x105x12 LD
						<b>21201075x3</b> 32x47x10 WD
<b>41401034</b> 026 198 025 A	<b>41401013</b> 028 103 609 A	<b>41401019</b> 026 129 717 D	<b>41401021x4</b> 026 129 589 A 056 129 589 B	<b>41408017</b> 841 253 115 B	<b>40107027x8</b> 026 109 675 <b>8x10,8/14,2x10</b>	<b>21204504</b> 85x105x12 LD
						<b>21201075x3</b> 32x47x10 WD
<b>41401034</b> 026 198 025 A	<b>41401013</b> 028 103 609 A	<b>41401019</b> 026 129 717 D	<b>41401021x4</b> 026 129 589 A 056 129 589 B	<b>41408017</b> 841 253 115 B	<b>40107027x8</b> 026 109 675 <b>8x10,8/14,2x10</b>	<b>21204504</b> 85x105x12 LD

■ : Delik - Çentik

■ : Hole - Notch

■ : Trou - Entaille

NOT: Katalogdaki Orijinal Kodlar Referans Amacıyla Kullanılmıştır.Lütfen Oto Conta Kodlarını Kullanınız.  
Original codes used for reference only.Please use OTO CONTA codes for orders.



AUDI

00



01



02



03







04



Silindir Kapak  
Cylinder Head  
Zylinderkopf  
Joint de culasse



Ltr MODEL PS/KW ENGINE/MOTOR

Ltr	MODEL	PS/KW	ENGINE/MOTOR		
1,6 1588	4 CYL ø76,5 DIESEL 80 08/80-->08/91 TURBO DIESEL 80 TD 08/81-->08/91 80 TD 08/85->09/91	55 PS / 40 KW 70 PS / 51 KW	JK CY RA SB	41402002 Motor Full Takım Gasket Full Set  41402003 068 198 012 L 068 198 012 E 033 198 012 A  41402004 037 198 011 C	 41402005 068 103 383 FN 1,60mm 3 ■ 41402006 068 103 383 FM 1,50mm 2 ■ 41402007 068 103 383 FL 1,40mm 1 ■ ø78,5  41403005 068 103 383 EK 1,61mm 3 ■ 41403006 068 103 383 EJ 1,57mm 2 ■ 41403007 068 103 383 EH 1,53mm 1 ■ ø78,5
1,8 1781	4 CYL ø81 AUDI COUPE 100 08/81-->11/90 80 08/82-->10/91 08/84-->10/91 09/86-->08/90	90 PS / 66 KW 75 PS / 55KW 112 PS / 82 KW 110 PS / 81 KW 113 PS / 83 KW	DD DR DS JV JW NP SH 4B DZ JN PH PM PV RS MU NE SF SD		 41408005 026 103 383 P 026 103 383 L 026 103 383 M 026 103 383 N 026 103 383 K 1,75mm ø83

▲ : İçerikte Bulunmamaktadır...

▲ : Not included in the set

▲ : Non inclus dans la pochette

00: Motor Takım Keçesiz ve Subap Lastiksiz

00: Gasket Set Without oil seals Without Valve Stem Seal













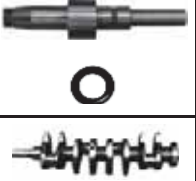

01: Motor Takım Keçesiz - Subap Lastikli

01: Gasket set With Valve Stem Seal Without Oil Seals

02: Motor Full Takım Keçeli ve Subap Lastikli

02: Gasket Full Set With oil seals and Valve Stem Seals

007

<p>Subap Kapak Valve Cover Gasket Zylinderkopfhaube Couvre-culbut.</p> 	<p>Karter Oil Pan Ölwanne Carter d'huile</p> 	<p>Emme Manifold Intake Manifold Ansaug Admission</p> 	<p>Egzoz Manifold Exhaust Manifold Auspuffkrümmer Collecteur D'echappement</p> 	<p>Eksoz Boğaz Exhaust Pipe Auspuff Kehle</p> 	<p>Supap Keçesi Valve Stem Seal Ventilschaft Queue de soupape</p> 	
 <p><b>41401034</b> 026 103 483 026 103 483 B 026 103 483 C 056 103 483 D</p>	 <p><b>41401013</b> 028 103 609 A 034 129 717 C</p>	 <p><b>41401019</b> 026 129 717D</p>  <p><b>41402019</b> 068 129 717 E</p>	 <p><b>41401021x4</b> 026 129 589 A 028 129 589 B</p>	 <p><b>41401017</b> 841 253 115 B</p>	 <p><b>40107027x8</b> 7553637 8x10,8/14,2x10</p>	<p><b>21201075x3</b> 32x47x10 WD</p> <p><b>21204504</b> 85x105x12 LD</p>

■ : Delik - Çentik

■ : Hole - Notch

■ : Trou - Entaille

NOT: Katalogdaki Orijinal Kodlar Referans Amacıyla Kullanılmıştır.Lütfen Oto Conta Kodlarını Kullanınız.  
Original codes used for reference only.Please use OTO CONTA codes for orders.



AUDI

00



01



02



03









04



Silindir Kapak  
Cylinder Head  
Zylinderkopf  
Joint de culasse



Ltr	MODEL	PS/KW	ENGINE/MOTOR		
1,9 1896	4 CYL ø79,5 80 D 08/89-->08/91 80 TD 08/91-->12/94	68 PS / 50 KW 75 PS / 55 KW	1Y AAZ	41405103 028 198 012 B  41405104 028 198 011 D 	 41405105 028 103 383 BD 1,70mm 3 ■ 41405106 028 103 383 BC 1,65mm 2 ■ 41405107 028 103 383 BB 1,60mm 1 ■ ø81
1,9 1896	4 CYL ø79,5 AUDI A80 TDI 09/91-->01/96 A4 TDI 01/95-->09/01 A6 TDI 06/94-->12/97 CABRIO TDI 06/95-->08/00	90 PS / 66 KW 110 PS / 81 KW 75 PS / 55 KW	1Z AHH AHU AFN AVG AFF	41405203 028 198 012 C  41405104 028 198 012 D 	 41405205 028 103 383 BR 028 103 383 BN 1,61mm 3 ■ 41405206 028 103 383 BQ 028 103 383 BM 1,53mm 2 ■ 41405207 028 103 383 BP 028 103 383 BL 1,45mm 1 ■ MLS ø81
2,0 1984	4 CYL ø82,5mm AUDI COUPE 05/89-->12/96 100 12/90-->06/94 80 01/93-->09/98 CABRIOLET 01/91--> 07/95 16 VALVE	112 PS / 82 KW 100 PS / 74 KW 115 PS / 82 KW 115 PS / 85 KW	AAD AAE ABK ABT ADW SD 3A		 41408105 048 103 383 B 1,75mm ø83,5

▲ : İçerikte Bulunmamaktadır...

▲ : Not included in the set

▲ : Non inclus dans la pochette

00: Motor Takım Keçesiz ve Subap Lastiksiz

00: Gasket Set Without oil seals Without Valve Stem Seal











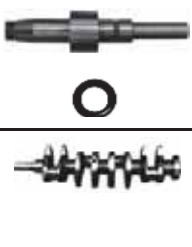





01: Motor Takım Keçesiz - Subap Lastikli

01: Gasket set With Valve Stem Seal Without Oil Seals

02: Motor Full Takım Keçeli ve Subap Lastikli

02: Gasket Full Set With oil seals and Valve Stem Seals

009

Subap Kapak Valve Cover Gasket Zylinderkopfhaube Couvre-culbut.	Karter Oil Pan Ölwanne Carter d'huile	Emme Manifold Intake Manifold Ansaug Admission	Egzoz Manifold Exhaust Manifold Auspuffkrümmer Collecteur D'echappement	Eksoz Boğaz Exhaust Pipe Auspuff Kehle	Supap Keçesi Valve Stem Seal Ventilschaft Queue de soupape	
						
 <b>41405125</b> 028 103 483 F 028 103 483 H		 <b>41405121</b> 028 129 717 D	 <b>41401021x4</b> 026 129 589 A 028 129 589 B		 <b>40107027x8</b> 7553637 <b>8x10,8/14,2x10</b>	<b>21208042</b> 32x47x10 WD <b>21204504</b> 85x105x12 LD <b>21208042x2</b> 32x47x10 WD
 <b>41405225</b> 028 103 483 C 028 103 483 G	 <b>41401014</b> 044 103 609 D	 <b>41405121</b> 028 129 717 D	 <b>41401021x4</b> 026 129 589 A 028 129 589 B		 <b>40107027x8</b> 7553637 <b>8x10,8/14,2x10</b>	<b>21208042</b> 32x47x10 WD <b>21204504</b> 85x105x12 LD <b>21208042x2</b> 32x47x10 WD

■ : Delik - Çentik

■ : Hole - Notch

■ : Trou - Entaille

NOT: Katalogdaki Orijinal Kodlar Referans Amacıyla Kullanılmıştır.Lütfen Oto Conta Kodlarını Kullanınız.  
Original codes used for reference only.Please use OTO CONTA codes for orders.



# CHEVROLET

00

Silindir Kapak  
Cylinder Head

01



Zylinderkopf

02



Joint de culasse

03



04



Ltr	MODEL	PS/KW	ENGINE/MOTOR		
0,8 796	3 CYL ø68,5 MATIZ SPARK 03/05-->	52 PS / 38 KW 50 PS / 30 KW	F8CV		 <b>41460105</b> 11141A78B01-00 2,00mm ø69,5
1,4 1393	4 CYL ø82 CHEVETTE 1976-->1977	85 PS / 45 KW	85		 <b>41415205</b> 1,20mm ø83
1,4 1393	4 CYL ø77,9 AVEO (SOHC )	83 PS / 61KW	F14S3		 <b>42447305</b> 5607408 1,40mm ø80,5
1,4 1399	4 CYL ø77,9 AVEO LACETTI NUBIRA OPTRA KALOS (DOCH 16 V )	94 PS / 69 KW	F14D3		 <b>42450105</b> 96473400 1,20mm FIBER / FIBRE ø80
1,6 1598	4 CYL ø79 AVEO KALOS NUBIRA OPTRA LACETTI CRUZE ( DOCH16V )	109 PS / 80 KW	F16D3 F16D4 A16DMS		 <b>42450205</b> 96378802 1,20mm FIBER / FIBRE ø80
1,6 1599	4 CYL ø82 CHEVETTE 1976-->1987	85 PS / 45 KW	98		 <b>41415205</b> 1,20mm ø83

▲ : İçerikte Bulunmamaktadır...

▲ : Not included in the set

▲ : Non inclus dans la pochette

00: Motor Takım Keçesiz ve Subap Lastiksiz

00: Gasket Set Without oil seals Without Valve Stem Seal

01: Motor Takım Keçesiz - Subap Lastikli

01: Gasket set With Valve Stem Seal Without Oil Seals

02: Motor Full Takım Keçeli ve Subap Lastikli

02: Gasket Full Set With oil seals and Valve Stem Seals





# CHEVROLET

00

Silindir Kapak  
Cylinder Head

01



Zylinderkopf

02



Joint de culasse

03



04



Ltr	MODEL	PS/KW	ENGINE/MOTOR		
1,6 1598	4 CYL ø77,9 AVEO LACETTI NUBIRA OPTRA KALOS (DOCH 16 V)	03/05-->01/09 94 PS / 69 KW	F16D3		 <b>42450105</b> 96473400 1,20mm FIBER / FIBRE ø80
2,0 1998	4 CYL ø86 VIVANT EPICA REZZO TACUMA EVANDA (DOCH 16 V)	2000-->2007 122 PS / 89 KW 2003 131 PS / 96 KW 01/05-->12/06 09/2000 08/02-->2006	T20SED X20SED		 <b>42447605</b> 5607449 1,40mm ø87,5

▲ : İçerikte Bulunmamaktadır...

▲ : Not included in the set

▲ : Non inclus dans la pochette

00: Motor Takım Keçesiz ve Subap Lastiksiz







00: Gasket Set Without oil seals Without Valve Stem Seal

01: Motor Takım Keçesiz - Subap Lastikli

01: Gasket set With Valve Stem Seal Without Oil Seals

02: Motor Full Takım Keçeli ve Subap Lastikli

02: Gasket Full Set With oil seals and Valve Stem Seals

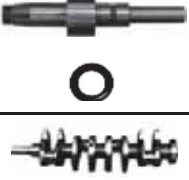
<p>Subap Kapak Valve Cover Gasket Zylinderkopfhaube Couvre-culbut.</p> 	<p>Karter Oil Pan Ölwanne Carter d'huile</p> 	<p>Emme Manifold Intake Manifold Ansaug Admission</p> 	<p>Egzoz Manifold Exhaust Manifold Auspuffkrümmer Collecteur D'echappement</p> 	<p>Eksoz Boğaz Exhaust Pipe Auspuff Kehle</p> 	<p>Supap Keçesi Valve Stem Seal Ventilschaft Queue de soupape</p> 	

■ : Delik - Çentik

■ : Hole - Notch

■ : Trou - Entaille

NOT: Katalogdaki Orijinal Kodlar Referans Amacıyla Kullanılmıştır.Lütfen Oto Conta Kodlarını Kullanınız.



# CHRYSLER

00



Silindir Kapak  
Cylinder Head  
Zylinderkopf  
Joint de culasse

01



02



03



04



Ltr	MODEL	PS/KW	ENGINE/MOTOR		
1,5 1468	4 CYL ø75,5 COLT PREMIER ( SOCH )	84 PS / 63 KW	G15B		 <b>41500305</b> MD016163 1,40mm  <b>41500306</b> MD016163 2,00mm ø76,5
1,5 1468	4 CYL ø75,5 COLT 12V ( SOCH )	90 PS / 66 KW	4G15		 <b>41415405</b> MD323473 1,40mm ø76,5
2,3 2346	4 CYL ø91 PICK-UP RAM 50 TD PICK-UP POWER RAM 50 TD ( SOCH ) 1983-->1985	68 PS / 50 KW	4D55T	<b>41450001</b> MD050092   <b>41450002</b> MD050092	 <b>41450005</b> MD050545 1,80mm  ø92,5

▲ : İçerikte Bulunmamaktadır...

▲ : Not included in the set

▲ : Non inclus dans la pochette

00: Motor Takım Keçesiz ve Subap Lastiksiz













00: Gasket Set Without oil seals Without Valve Stem Seal

01: Motor Takım Keçesiz - Subap Lastikli

01: Gasket set With Valve Stem Seal Without Oil Seals

02: Motor Full Takım Keçeli ve Subap Lastikli

02: Gasket Full Set With oil seals and Valve Stem Seals

<p>Subap Kapak Valve Cover Gasket Zylinderkopfhaube Couvre-culbut.</p> 	<p>Karter Oil Pan Ölwanne Carter d'huile</p> 	<p>Emme Manifold Intake Manifold Ansaug Admission</p> 	<p>Egzoz Manifold Exhaust Manifold Auspuffkrümmer Collecteur D'echappement</p> 	<p>Eksoz Boğaz Exhaust Pipe Auspuff Kehle</p> 	<p>Supap Keçesi Valve Stem Seal Ventilschaft Queue de soupape</p> 	  
 <p><b>41450025</b> MD050312</p>	 <p><b>41450013</b> MD149392</p>	 <p><b>41450021</b> MD050482</p>			 <p><b>41450026x8</b> 8x13x9x13</p>	<p><b>21201013</b> 35x50x8 RD</p> <p><b>21201023</b> 44x60x7 RD</p> <p><b>21201035</b> 80x96x9 LD</p> <p><b>21201004</b> 25x35x6</p> <p><b>21201001</b> 17x28x7</p>

■ : Delik - Çentik

■ : Hole - Notch

■ : Trou - Entaille

NOT: Katalogdaki Orijinal Kodlar Referans Amacıyla Kullanılmıştır.Lütfen Oto Conta Kodlarını Kullanınız.  
Original codes used for reference only.Please use OTO CONTA codes for orders.



CITROEN

00



01



02



03



04



Silindir Kapak  
Cylinder Head  
Zylinderkopf  
Joint de culasse



Ltr	MODEL	PS/KW	ENGINE/MOTOR		
1,0 954	4 CYL ø70 LNA 10 07/84->10 /86 VISA 10 C 15	45 PS / 33 KW	108C	41216002 198,57	 41216005 0203.84 1,20mm Loc ø16mm 41216006 0203.22 1,40mm ø74
1,0 954	4 CYL ø70 AX10 07/86-->12/98 AX10 07/92->12/98 AX10 07/92->12/98 C15E 10/84->12/97 SAXO 05/98-> SAXO 1996-> SAXO 05/1996->	45PS / 33KW 50PS / 37KW 50PS / 37KW 45PS / 33KW 45PS / 33KW 45PS / 33KW	C1A (TU9) CDZ (TU9M) CDY (TU9M) C1A (TU9) CDY (TU9L) C1A (TU9M) CDZ (TU9L)	41221002 Motor Full Takım Gasket Full Set 41221003 0197.H8+0209.89 41209004 0197.H9	 41221005 0209.89 1,30mm 1 ■ 41221006 0209.90 1,50mm 2 ■ ø73,5
1,1 1124	4 CYL ø72 BERLINGO 07/96-> SAXO 05/96-> ZX 07/96->08/97 INJECTION	60PS / 44KW 60PS / 44KW 60PS / 44KW	HDY (TU1M+) HDZ(TU1M+) TU1M+	41221002 Motor Full Takım Gasket Full Set 41221003 0197.H8+0209.89 41209004 0197.H9	 41221005 0209.89 1,30mm 1 ■ 41221006 0209.90 1,50mm 2 ■ ø73,5
1,1 1124	4 CYL ø72 AX 11 1986->1997 AX 11 4x4 06/94->07/92 BX 11 10/86->06/92 C15 E 07/88->12/96 ZX 07/91->06/95	55PS / 40KW 55PS / 40KW 55PS / 40KW 55PS / 40KW 55PS / 40KW	H1B (TU1CLC ) HDZ (TU1M ) H1A (TU1 ) H1A (TU1 ) H1A (TU1 ) TU1MZ	41209002 Motor Full Takım Gasket Full Set 41209003 0197.H8+0209.CJ 41209004 0197.H9	 41209005 0209.CJ 1,30mm 1 ■ 41209006 0209.W6 - W7 1,50 mm 2 ■ ø76

▲ : İçerikte Bulunmamaktadır...

▲ : Not included in the set

▲ : Non inclus dans la pochette

00: Motor Takım Keçesiz ve Subap Lastiksiz











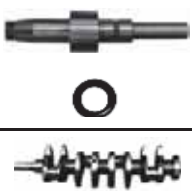







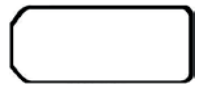
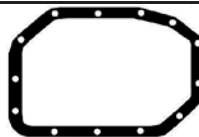











00: Gasket Set Without oil seals Without Valve Stem Seal

01: Motor Takım Keçesiz - Subap Lastikli

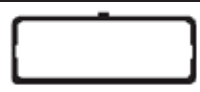
01: Gasket set With Valve Stem Seal Without Oil Seals

02: Motor Full Takım Keçeli ve Subap Lastikli

02: Gasket Full Set With oil seals and Valve Stem Seals

Subap Kapak Valve Cover Gasket Zylinderkopfhaube Couvre-culbut.	Karter Oil Pan Ölwanne Carter d'huile	Emme Manifold Intake Manifold Ansaug Admission	Egzoz Manifold Exhaust Manifold Auspuffkrümmer Collecteur D'échappement	Eksoz Boğaz Exhaust Pipe Auspuff Kehle	Supap Keçesi Valve Stem Seal Ventilschaft Queue de soupape	
						
 41201525 0249.39	 41201013 0304.46	 41201018 0384.54	 41201020 0349.16	 41205017 7700657683	 40107027x8 956,22 8x10.8/14.2x10	21201013 35x50x8 WD  21201033 78x100x10 LD
 41209025 0249.54	 41209013 0304.304	 41209019x2	 41209020x2 0349,A6	 41209017 1709.15	 40116026x8 0956.19 7x9,8/13.2x10	21201062 36x50x7 RD  21201021 42x66x6 RD  21204504 85x105x8 LD
 41209025 0249.54	 41209013 0304.304	 41209019x2	 41209020x2 0349,A6	 41209017 1709.15	 40116026x8 0956.19 7x9,8/13.2x10	21201062 36x50x7 RD  21201021 42x66x6 RD  21204504 85x105x8 LD
 41209025 0249.54	 41209013 0304.304	 41209019x2	 41209020x2 0349,A6	 41209017 1709.15	 40116026x8 0956.19 7x9,8/13.2x10	21201062 36x50x7 RD  21201021 42x66x6 RD  21204504 85x105x8 LD

■ : Delik - Çentik

■ : Hole - Notch

■ : Trou - Entaille

NOT: Katalogdaki Orijinal Kodlar Referans Amacıyla Kullanılmıştır.Lütfen Oto Conta Kodlarını Kullanınız.  
Original codes used for reference only.Please use OTO CONTA codes for orders.



# CITROEN

00



01



02



03



04



Silindir Kapak  
Cylinder Head  
Zylinderkopf  
Joint de culasse



Ltr	MODEL	PS/KW	ENGINE/MOTOR		
1,1 1124	<b>4 CYL ø72</b> BERLINGO C2 C3 SAXO 07/96--> 09/03--> 02/02--> 05/96-->	60PS / 44 KW	HFX ( TU1JP )		 <b>41222005</b> 0209.Y0 1,30mm 1 <b>41222006</b> 0209.Y1 1,50mm 2 ø74
1,1 1118	<b>4 CYL ø74</b> C15 E 10/84->10/96	48PS / 35KW	E1A (E1 )		 <b>41208005</b> 0209.H9 1,20mm ø77
1,3 1294	<b>4 CYL ø75</b> AX 13 SPORT 04/87-->12/88	95PS / 70KW	M4A	<b>41209002</b> Motor Full Takım Gasket Full Set <b>41209003</b> 0197.H8+0209.CJ <b>41209004</b> 0197.H9	 <b>41209005</b> 0209.CJ 1,30mm 1 <b>41209006</b> 0209.W6 - W7 1,50 mm 2 ø76
1,4 1360	<b>4 CYL ø75</b> VISA GT BX 14 C15 VISA 07/82-->04/85 04/83-->02/93	72PS / 53KW 67PS / 49 KW 75PS / 55 KW	150A 150B 150C 150D 150F	<b>41201002</b> 0197.77	 <b>41201005</b> 0209.A6 1,30mm Loc 14mm ø76
1,4 1360	<b>4 CYL ø75</b> C2 C3 C4 16 V 06/06--> 12/03--> 11/04-->	88PS / 65KW	KFU (ET3J4)		 <b>42190005</b> 0209.CH 0209.FL 1,40mm ø76

▲ : İçerikte Bulunmamaktadır...

▲ : Not included in the set

▲ : Non inclus dans la pochette

00: Motor Takım Keçesiz ve Subap Lastiksiz











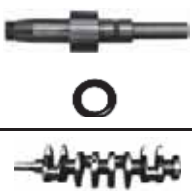





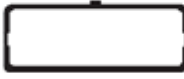

00: Gasket Set Without oil seals Without Valve Stem Seal

01: Motor Takım Keçesiz - Subap Lastikli

01: Gasket set With Valve Stem Seal Without Oil Seals

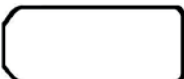
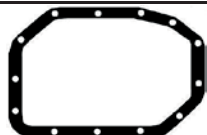
02: Motor Full Takım Keçeli ve Subap Lastikli

02: Gasket Full Set With oil seals and Valve Stem Seals

Subap Kapak Valve Cover Gasket Zylinderkopfhaube Couvre-culbut.	Karter Oil Pan Ölwanne Carter d'huile	Emme Manifold Intake Manifold Ansaug Admission	Egzoz Manifold Exhaust Manifold Auspuffkrümmer Collecteur D'echappement	Eksoz Boğaz Exhaust Pipe Auspuff Kehle	Supap Keçesi Valve Stem Seal Ventilschaft Queue de soupape	
						
						<b>21201062</b> 36x50x7 RD
<b>41209025</b> 0249.54	<b>41209013</b> 0304.304	<b>41209019x2</b>	<b>41209020x2</b> 0349,A6	<b>41209017</b> 1709.15	<b>40116026x8</b> 0956.19 7x9,8/13.2x10	<b>21201021</b> 42x66x6 RD
						<b>21204504</b> 85x105x8 LD
						<b>21201013</b> 35x50x8 WD
<b>41201525</b> 0249.39	<b>41201013</b> 0304.46	<b>41201018</b> 0384.54	<b>41201020</b> 0349.16	<b>41205017</b> 7700657683	<b>40107027x8</b> 956,22 8x10.8/14.2x10	<b>21201033</b> 78x100x10 LD

■ : Delik - Çentik

■ : Hole - Notch

■ : Trou - Entaille

NOT: Katalogdaki Orijinal Kodlar Referans Amacıyla Kullanılmıştır.Lütfen Oto Conta Kodlarını Kullanınız.  
Original codes used for reference only.Please use OTO CONTA codes for orders.



# CITROEN

00



01



02



03











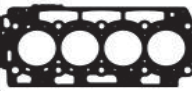

04



Silindir Kapak  
Cylinder Head  
Zylinderkopf  
Joint de culasse



Ltr	MODEL	PS/KW	ENGINE/MOTOR		
1,4 1398	<b>4 CYL ø74</b> C1 HDI 06/05--> C2 HDI 09/03--> C3 HDI 02/02--> C3 Pluriel HDI 04/04--> XSARA HDI 01/03-->08/05 Nemo HDI 02/08-->	68PS / 50KW 54PS / 40KW	DV4D DV4TD 8HX(DV4TD)	<b>41706002</b> Motor Full Takım Gasket Full Set  <b>41706003</b> Motor Üst Takım Gasket Head Set  <b>41706004</b> Motor Alt Takım Conversion Set	 <b>41706005</b> 0209.AH 1,45mm 5  <b>41706006</b> 0209.AG 1,40mm 4  <b>41706007</b> 0209.AE 1,30mm 3  <b>41706008</b> 0209.AC 1,25mm 2  <b>41706009</b> 0209.AF 1,35mm 1  MLS ø75
1,4 1360	<b>4 CYL ø75</b> BERLINGO 03/91--> SAXO VTS XSARA ZX C2 02/02--> C3 C3 Pluriel AX 04/83-->10/97 AX 14 BX 14 C15 ZX	75PS / 55KW 73PS / 53KW 85PS / 62 KW 54PS / 40 KW	KFW (TU3JP) KFX (TU3JP) TU3JP KFV (TU3JP) KAY (TU3CP) KAZ KDX (TU3M/Z) KDY (TU3FM) KDY (TU3M) K1B K1F K1G K1H (TU3A) K2A K2B K2D K3A	<b>41209002</b> Motor Full Takım Gasket Full Set <b>41209003</b> 0197.H8+0209.CJ <b>41209004</b> 0197.H9	 <b>41209005</b> 0209.CJ 1,30mm 1  <b>41209006</b> 0209.W6 - W7 1,50 mm 2  ø76

▲ : İçerikte Bulunmamaktadır...

▲ : Not included in the set

▲ : Non inclus dans la pochette

00: Motor Takım Keçesiz ve Subap Lastiksiz











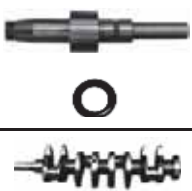





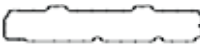

00: Gasket Set Without oil seals Without Valve Stem Seal

01: Motor Takım Keçesiz - Subap Lastikli

01: Gasket set With Valve Stem Seal Without Oil Seals

02: Motor Full Takım Keçeli ve Subap Lastikli

02: Gasket Full Set With oil seals and Valve Stem Seals

Subap Kapak Valve Cover Gasket Zylinderkopfhaube Couvre-culbut.	Karter Oil Pan Ölwanne Carter d'huile	Emme Manifold Intake Manifold Ansaug Admission	Egzoz Manifold Exhaust Manifold Auspuffkrümmer Collecteur D'echappement	Eksoz Boğaz Exhaust Pipe Auspuff Kehle	Supap Keçesi Valve Stem Seal Ventilschaft Queue de soupape	
						
						<b>21204017</b> 27x47x7 RD
<b>41706025</b> 0249.C1 0249.F8 1 148 101	<b>42427465</b>	<b>41706019x4</b> 0348.R2 0348.T8	<b>41706021</b> 0349.J8 0349.J7		<b>41706027x8</b> 0956.50 5,5x9,5x22,9x17,5	<b>21204018</b> 40x55x6,4 LD
						<b>21204019</b> 85x105x8,8 RD
						<b>21201062</b> 36x50x7 RD
<b>41209025</b> 0249.54	<b>41209013</b> 0304.304	<b>41209019x2</b>	<b>41209020x2</b> 0349,A6	<b>41209017</b> 1709.15	<b>40116026x8</b> 0956.19 7x9,8/13.2x10	<b>21201021</b> 42x66x6 RD
						<b>21204504</b> 85x105x8 LD

■ : Delik - Çentik

■ : Hole - Notch

■ : Trou - Entaille

NOT: Katalogdaki Orijinal Kodlar Referans Amacıyla Kullanılmıştır.Lütfen Oto Conta Kodlarını Kullanınız.  
Original codes used for reference only.Please use OTO CONTA codes for orders.



CITROEN

00



01



02



03



04



Silindir Kapak  
Cylinder Head  
Zylinderkopf  
Joint de culasse



Ltr	MODEL	PS/KW	ENGINE/MOTOR		
1,4 1360	4 CYL ø75 AX AX 14 BX14 C 15 ZX 09/1986-->06/1997	85PS / 62 KW 55PS / 40KW	KDZ (TU3M/Z) KAY (TU3CP) K1B K1F K1G K1H (TU3A) K2A K2B K3A	41209002 Motor Full Takım Gasket Full Set 41209003 0197.H8+0209.CJ 41209004 0197.H9	 41209005 0209.CJ 1,30mm 1 41209006 0209.W6 - W7 1,50 mm 2 ø76
1,6 1560	4 CYL ø75 BERLINGO HDI BERLINGO HDI 75 BERLINGO HDI 90 C2 HDI C3 HDI C3 HDI 16V C4 C4 HDI C4 HDI 110 FAP C4 HDI 90 C5 HDI XSARA PICASSO HDI 05/04--> 11/04-->	109PS / 80 KW 90PS / 66 KW	DV6ATED4 DV6B DV6TED4 9HT (DV6BTED4) 9HT (DV6BUTED4) 9HX (DV6ATED4) 9HY (DV6TED4) 9HZ (DV6TED4)	41707002 Motor Full Takım Gasket Full Set  41707003 Motor Üst Takım Gasket Head Set  41707004 Motor Alt Takım Conversion Set	 41707005 0209.CG 1,45mm 5 41707006 0209.CF 1,40mm 4 41707007 0209.CC 1,30mm 3 41707008 0209.CA 1,25mm 2 41707009 0209.CE 1,35mm 1 MLS ø76
1,6 1587	4 CYL ø78,5 BERLINGO BERLINGO 16V C2 C3 Pluriel C3 16V C4 C4 16V XSARA PICASSO 16V XSARA 16V C2 VTS 09/00--> 01/05-->	110PS / 81KW 90PS / 66 KW 122PS / 90 KW	NFR (TU5JP4B) NFU (TU5JP4) NFS (TU5JP4S)		 42200005 0209.1E MLS ø79,5

▲ : İçerikte Bulunmamaktadır...

▲ : Not included in the set

▲ : Non inclus dans la pochette

00: Motor Takım Keçesiz ve Subap Lastiksiz

00: Gasket Set Without oil seals Without Valve Stem Seal





















01: Motor Takım Keçesiz - Subap Lastikli

01: Gasket set With Valve Stem Seal Without Oil Seals

02: Motor Full Takım Keçeli ve Subap Lastikli

02: Gasket Full Set With oil seals and Valve Stem Seals

023

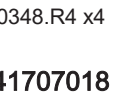
Subap Kapak Valve Cover Gasket Zylinderkopfhaube Couvre-culbut.	Karter Oil Pan Ölwanne Carter d'huile	Emme Manifold Intake Manifold Ansaug Admission	Egzoz Manifold Exhaust Manifold Auspuffkrümmer Collecteur D'echappement	Eksoz Boğaz Exhaust Pipe Auspuff Kehle	Supap Keçesi Valve Stem Seal Ventilschaft Queue de soupape	
						
						<b>21201062</b> 36x50x7 RD
<b>41209025</b> 0249.54	<b>41209013</b> 0304.304	<b>41209019x2</b>	<b>41209020x2</b> 0349,A6	<b>41209017</b> 1709.15	<b>40116026x8</b> 0956.19 7x9,8/13.2x10	<b>21201021</b> 42x66x6 RD
						<b>21204017</b> 27x47x7 RD
<b>41707025</b> 0249.C2	<b>42427465</b>		<b>41706021</b> 0349.J8 0349.J7 0349.N0 1 148 115		<b>41707026x16</b> 0956.51 5,5x9,5x18,1x14	<b>21204018</b> 40x55x6,4 LD
						<b>21204019</b> 85x105x8,8 RD
		<b>41707018</b> 0348.R5+0348.R4				

■ : Delik - Çentik

■ : Hole - Notch

■ : Trou - Entaille

NOT: Katalogdaki Orijinal Kodlar Referans Amacıyla Kullanılmıştır.Lütfen Oto Conta Kodlarını Kullanınız.  
Original codes used for reference only.Please use OTO CONTA codes for orders.



CITROEN

00



01



02



03



04



Silindir Kapak  
Cylinder Head  
Zylinderkopf  
Joint de culasse



Ltr	MODEL	PS/KW	ENGINE/MOTOR		
1,6 1580	4 CYL ø83 BX 10/82-->12/94 BX16 01/87-->10/97 ZX VISA 16 GTI	88 PS / 65 KW 72 PS / 53 KW 116 PS / 85 KW 87 PS / 64 KW	BAY (XU5CP) BAZ (XU5CP) BDY (XU5M) BDZ (XU5M) B1A (XU51C/K) B1E (XU51C) B6D XU52C 171A 171B 171C 171D 180Z	41207002 0197.89+0209.E1 41207003 0197.H6+0209.E1 42130002 0197.89+0209.L3 42130003 0197.H6+0209.L3	 41207005 0209.E1 1,30mm 1 41207006 0209.L8 1,50mm 2  42130005 0209.L3 1,50mm ø84,5
1,6 1580	4 CYL ø83 XANTIA 03/91-->01/98 ZX	88 PS / 65 KW	BFZ (XU5JP)	41233002 0197.G4+0209.E1	 41207005 0209.E1 1,30mm 1 41207006 0209.L8 1,50mm 2 ø84,5
1,8 1769	4 CYL ø80 BERLINGO D 04/84--> BX 18 D C15 D VISA 17 D XSARA D ZX D	60 PS / 44 KW 58 PS / 43 KW	A9A (XUD7) 161 (XUD7) 161A (XUD7)	41204002 0197.H5  41204003 0197.H4 	 41203009 0209.S0 1,36 mm. 1 41203008 0209.S1 1,40 mm. 2 41203007 0209.S2 1,44 mm. 3 41203006 0209.S3 1,48 mm. 4 41203005 0209.S4 1,53 mm. 5 ø82

▲ : İçerikte Bulunmamaktadır...

▲ : Not included in the set

▲ : Non inclus dans la pochette

00: Motor Takım Keçesiz ve Subap Lastiksiz











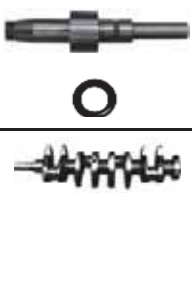



















00: Gasket Set Without oil seals Without Valve Stem Seal

01: Motor Takım Keçesiz - Subap Lastikli

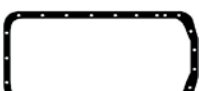
01: Gasket set With Valve Stem Seal Without Oil Seals

02: Motor Full Takım Keçeli ve Subap Lastikli

02: Gasket Full Set With oil seals and Valve Stem Seals

Subap Kapak Valve Cover Gasket Zylinderkopfhaube Couvre-culbut.	Karter Oil Pan Ölwanne Carter d'huile	Emme Manifold Intake Manifold Ansaug Admission	Egzoz Manifold Exhaust Manifold Auspuffkrümmer Collecteur D'echappement	Eksoz Boğaz Exhaust Pipe Auspuff Kehle	Supap Keçesi Valve Stem Seal Ventilschaft Queue de soupape	
						
 <b>41207525</b> 0249.48 91508054	 <b>41203013</b> 0304.34 93502226  <b>41203014</b> 93501565	 <b>41203018x2</b> 91508659. BX->1984  <b>41207018</b> 951299280  <b>41207019</b> 0348.76	 <b>41207020x4</b> 0349.70 91505500  <b>41205019</b> 1721.01 7810024000	 <b>41207017</b> 1710.39 91511460	 <b>40107027x8</b> 0956.22 8x10,8/14,2x10	<b>21201062</b> 36x50x7 RD <b>21201019</b> 42x62x8 RD <b>21201040</b> 90x110x10 LD
 <b>41233025</b> 0249.71	 <b>41203013</b> 0304.34 93502226.	 <b>41233018x4</b> 0348.E6 + 0348F6	 <b>41233020x4</b> 1723.63		 <b>40107027x8</b> 0956.22 8x10,8/14,2x10	<b>21201062</b> 36x50x7 RD <b>21201019</b> 42x62x8 RD <b>21201040</b> 90x110x10 LD
 <b>41203525</b> 0249.46 0249.91 93501444	 <b>41203013</b> 0304.34 93502226.  <b>41203014</b> 93501565	 <b>41203020x2</b> 9456044080  <b>41203018</b> 9456043980	 <b>41205019</b> 1721.01 7810024000  <b>41203120x2</b> 0349.78		 <b>40107027x8</b> 0956.22 8x10,8/14,2x10	<b>21201062</b> 36x50x7 RD <b>21201019</b> 42x62x8 RD <b>21201040</b> 90x110x10 LD

■ : Delik - Çentik

■ : Hole - Notch

■ : Trou - Entaille

NOT: Katalogdaki Orijinal Kodlar Referans Amacıyla Kullanılmıştır.Lütfen Oto Conta Kodlarını Kullanınız.  
Original codes used for reference only.Please use OTO CONTA codes for orders.



CITROEN

00



01



02



03



04



Silindir Kapak  
Cylinder Head  
Zylinderkopf  
Joint de culasse



Ltr	MODEL	PS/KW	ENGINE/MOTOR		
1,8 1761	4 CYL ø83 XANTIA XSARA ZX 07/92-->09/00	101 PS / 74 KW	LFZ (XU7JP)	41233002 0197.G4+0209.E1	 41207005 0209.E1 1,30mm 1  41207006 0209.L8 1,50mm 2 ø84,5
1,8 1761	4 CYL ø83 XANTIA 16V XSARA PICASSO 16V XSARA 16V ZX ZX 16V 06/95-->	115 PS / 85 KW 110 PS / 81 KW	LFY (XU7JP4)		 42220005 0209.Q3 1,20mm 1 42220006 0209.V4 1,40mm 2 42220007 1,60mm 3 ø84
1,8 1769	4 CYL ø 84 C 25 07/87->02/94	69 PS / 51 KW	169 (XM7T)	41210001 0197.L1 0197.15	 41210005 0209.F8 ø86,7
1,9 1,905	4 CYL ø83 BX 19 BX 19 GTI ZX 06/88-->12/94 07/86-->12/94 12/87-->06/97	109 PS / 80 KW 102 PS / 75 KW 120 PS / 88 KW 95 PS / 70 KW 122 PS / 90 KW	DDZ (XU9M) DFZ (XU9J1) DKZ (XU9JA) D2C (XU92C) D2F D2A (XU92C) D2C (XU92C) D6A (XU9J2) 159A D6E (XU9JA)	41207002 0197.89+0209.E1  41207003 0197.H6+0209.E1	 41207005 0209.E1 1,30mm 1  41207006 0209.L8 1,50mm 2 ø84,5

▲ : İçerikte Bulunmamaktadır...

▲ : Not included in the set

▲ : Non inclus dans la pochette

00: Motor Takım Keçesiz ve Subap Lastiksiz

00: Gasket Set Without oil seals Without Valve Stem Seal











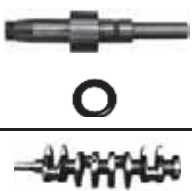







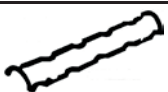



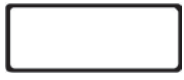

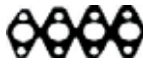

01: Motor Takım Keçesiz - Subap Lastikli

01: Gasket set With Valve Stem Seal Without Oil Seals

02: Motor Full Takım Keçeli ve Subap Lastikli

02: Gasket Full Set With oil seals and Valve Stem Seals

027

Subap Kapak Valve Cover Gasket Zylinderkopfhaube Couvre-culbut.	Karter Oil Pan Ölwanne Carter d'huile	Emme Manifold Intake Manifold Ansaug Admission	Egzoz Manifold Exhaust Manifold Auspuffkrümmer Collecteur D'echappement	Eksoz Boğaz Exhaust Pipe Auspuff Kehle	Supap Keçesi Valve Stem Seal Ventilschaft Queue de soupape	
						
 <b>41233025</b> 0249.71	 <b>41203013</b> 0304.34 93502226.	 <b>41233018x4</b> 0348.E6 + 0348F6	 <b>41233020x4</b> 1723.63		 <b>40107027x8</b> 0956.22 <b>8x10,8/14,2x10</b>	<b>21201019</b> 42x62x8 RD <b>21201040</b> 90x110x10 LD <b>21201062</b> 36x50x7 RD
 <b>41210525</b> 0249.14	 <b>41210013</b> 0304.44	 <b>41211016</b> 0348.33	 <b>41210020</b> 0349.03		 <b>40107027x8</b> 0956.22 <b>8x10,8/14,2x10</b>	
 <b>41207525</b> 0249.48 91508054	 <b>41203013</b> 0304.34 93502226  <b>41203014</b> 93501565	 <b>41203018x2</b> 91508659. BX->1984  <b>41207018</b> 951299280  <b>41207019</b> 0348.76	 <b>41207020x4</b> 0349.70 91505500  <b>41205019</b> 1721.01 7810024000	 <b>41207017</b> 1710.39 91511460	 <b>40107027x8</b> 0956.22 <b>8x10,8/14,2x10</b>	<b>21201019</b> 42x62x8 RD <b>21201040</b> 90x110x10 LD <b>21201062</b> 36x50x7 RD

■ : Delik - Çentik

■ : Hole - Notch

■ : Trou - Entaille

NOT: Katalogdaki Orijinal Kodlar Referans Amacıyla Kullanılmıştır.Lütfen Oto Conta Kodlarını Kullanınız.  
Original codes used for reference only.Please use OTO CONTA codes for orders.



CITROEN

00



01



02



03



04



Silindir Kapak  
Cylinder Head  
Zylinderkopf  
Joint de culasse



Ltr	MODEL	PS/KW	ENGINE/MOTOR		
1,9 1905	4 CYL ø83 BERLINGO D 09/83-->12/94 BX 19 D C25 C25 Bus D C25 D JUMPER Bus D JUMPER D JUMPY D XANTIA D XSARA D ZX D DIESEL	70 PS / 51 KW 64 PS / 47 KW 68 PS / 50 KW	DJY (XUD9A) DJZ (XUD9Y) D9B (XUD9A/L) D9B (XUD9A/U) DHY (XUD9TE/Y) D9A (XUD9) 162 (XUD9) 162 (XUD9) DJZ (XUD9) D9B (XUD9) 169B(XUD0) XUD9A 169B(XUD0) 169B(XUD0)	41204002 0197.H5  41204003 0197.H4 	Silindir Kapak Cylinder Head Zylinderkopf Joint de culasse  41204009 0209.S5 1,36 mm 1 41204008 0209.S6 1,40 mm 2 41204007 0209.S7 1,44 mm 3 41204006 0209.S8 1,48 mm 4 41204005 0209.S9 1,53 mm 5 ø 84
1,9 1868	4 CYL ø82,2 BERLINGO D JUMPY D XSARA D	70 PS / 51 KW	DW8B WJY (DW8B) WJZ (DW8)	42173002 0197.X6 	Silindir Kapak Cylinder Head Zylinderkopf Joint de culasse  42173005 0209.1C 1,47mm 42173006 0209.X4 1,42mm 5 42173007 0209.X3 1,38mm 4 42173008 0209.X2 1,34mm 3 42173009 0209.X1 1,30mm 2 42173010 0209.X0 1,26mm 1 MLS ø84
2,0 1971	4 CYL ø 88 C25 09/81-->03/94 C25 Bus	79 PS / 58 KW 84 PS / 62 KW	170A (XN1T) 170B (XN1T) 170C (XN1T)	41211001 9400197139	Silindir Kapak Cylinder Head Zylinderkopf Joint de culasse  41211005 0209.46 1,20mm 41211006 1,80mm ø90

▲ : İçerikte Bulunmamaktadır...

▲ : Not included in the set

▲ : Non inclus dans la pochette

00: Motor Takım Keçesiz ve Subap Lastiksiz











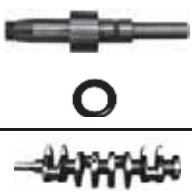







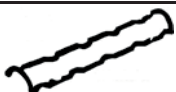





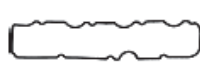

00: Gasket Set Without oil seals Without Valve Stem Seal

01: Motor Takım Keçesiz - Subap Lastikli

01: Gasket set With Valve Stem Seal Without Oil Seals

02: Motor Full Takım Keçeli ve Subap Lastikli

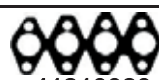
02: Gasket Full Set With oil seals and Valve Stem Seals

Subap Kapak Valve Cover Gasket Zylinderkopfhaube Couvre-culbut.	Karter Oil Pan Ölwanne Carter d'huile	Emme Manifold Intake Manifold Ansaug Admission	Egzoz Manifold Exhaust Manifold Auspuffkrümmer Collecteur D'echappement	Eksoz Boğaz Exhaust Pipe Auspuff Kehle	Supap Keçesi Valve Stem Seal Ventilschaft Queue de soupape	
						
 <b>41203525</b> 0249.46 0249.91	 <b>41203013</b> 0304.34  <b>41203014</b> 93501565	 <b>41203116x2</b> 0348.99  <b>41203018x2</b> 91508659  <b>41203021</b> 0348.JO	 <b>41205019</b> 1721.01 7810024000  <b>41203120x2</b> 0349.47 93010402		 <b>40107027x8</b> 0956.22 8x10,8/14,2x10	<b>21201011x2</b> 35x50x8 WD <b>21201019</b> 42x62x8 RD <b>21201040</b> 90x110x7 LD
 <b>42173025</b> 0249.95	 <b>41203013</b> 0304.34	 <b>42173018x2</b> 0348.N2	 <b>42173021x2</b> 0349.H7		 <b>40107027x8</b> 0956.22 8x10,8/14,2x10	<b>21208023</b> 35x50x8 RD <b>21201019</b> 42x62x8 RD <b>21201040</b> 90x110x10 LD
 <b>41210525</b> 0249.14	 <b>41210013</b> 0322.10 0304.11	 <b>41211016</b> 0348.33  <b>41211015</b> 0348.21	 <b>41210020</b> 0349.03	 <b>41205017</b> 1710.09	 <b>40107027x8</b> 0956.22 8x10,8/14,2x10	

■ : Delik - Çentik

■ : Hole - Notch

■ : Trou - Entaille

NOT: Katalogdaki Orijinal Kodlar Referans Amacıyla Kullanılmıştır. Lütfen Oto Conta Kodlarını Kullanınız.  
Original codes used for reference only. Please use OTO CONTA codes for orders.



## CITROEN

00

Silindir Kapak  
Cylinder Head

01



Zylinderkopf

02



Joint de culasse

03



04



Ltr	MODEL	PS/KW	ENGINE/MOTOR		
2,0 1998	4 CYL ø86 EVASION 16V 05/98-->04/00 XANTIA 16V 06/95-->04/03 XM 16V 05/94-->10/00 XSARA 16V 07/98-->09/00	132 PS / 97 KW	RFV (XU10J4R)		 <b>42170005</b> 0209.N6 1,35 mm 1 ■  <b>42170006</b> 0209.T9 1,50mm 2 ■  ø87
2,5 2500	4 CYL ø93 CX 25 D 02/78-->02/94 CX 25 TRI CX 2500 D C25 Bus D C25 D	136 PS / 100KW 73 PS / 54 KW	CRD93L (U25-661) M25-629 M25-659 M25-660	<b>41215003</b> 0197K1	 <b>41215005</b> 0209.L5 1,40mm ø95,5
2,5 2500	4 CYL ø93 CX 25 TD 04/83-->02/94 CX 2500 TD C25 Bus TD C25 DT	120 PS / 88 KW 95 PS / 75 KW	CRD93LS (U25-673) M25-648 M25-669	<b>41215103</b> 0197K1 TD	 <b>41215105</b> 0209.L6 1,40mm ø95,5
2,8 2798	4 CYL ø94.4 JUMPER HDI 09/04-->04/02 JUMPER HDI JUMPER 09/00-->06/06	128 PS / 94 KW 146 PS / 107 KW 87 PS / 64 KW	F28TDCR 8140.43N 8140.43S	<b>40139100</b> 0197.Z4 0197.Y9 0197.Y2 	 <b>40139005</b> 0209.OF 1,50mm  <b>40139006</b> 0209.OE 1,40mm  <b>40139007</b> 0209.OC 1,30mm ø96

▲ : İçerikte Bulunmamaktadır...

▲ : Not included in the set

▲ : Non inclus dans la pochette

00: Motor Takım Keçesiz ve Subap Lastiksiz











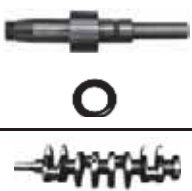







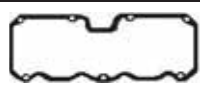

00: Gasket Set Without oil seals Without Valve Stem Seal

01: Motor Takım Keçesiz - Subap Lastikli

01: Gasket set With Valve Stem Seal Without Oil Seals

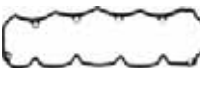
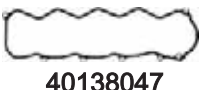
02: Motor Full Takım Keçeli ve Subap Lastikli

02: Gasket Full Set With oil seals and Valve Stem Seals

Subap Kapak Valve Cover Gasket Zylinderkopfhaube Couvre-culbut.	Karter Oil Pan Ölwanne Carter d'huile	Emme Manifold Intake Manifold Ansaug Admission	Egzoz Manifold Exhaust Manifold Auspuffkrümmer Collecteur D'echappement	Eksoz Boğaz Exhaust Pipe Auspuff Kehle	Supap Keçesi Valve Stem Seal Ventilschaft Queue de soupape	
						
 <b>41215025</b> 5 450 155		 <b>41215019x4</b> 0348.H0	 <b>41215021x4</b> 0349.F0	 <b>41215017</b> 95494600		
 <b>41215025</b> 5 450 155		 <b>41215019x4</b> 0348.H0	 <b>41215021x4</b> 0349.F0	 <b>41215017</b> 95494600		
 <b>40138045</b> 0249.A0  <b>40138047</b> 0249.C3	 <b>40138068</b> 500327440	 <b>40146019x4</b> 98425767	 <b>40147021x4</b> 98434020			

■ : Delik - Çentik

■ : Hole - Notch

■ : Trou - Entaille

NOT: Katalogdaki Orijinal Kodlar Referans Amacıyla Kullanılmıştır.Lütfen Oto Conta Kodlarını Kullanınız.  
Original codes used for reference only.Please use OTO CONTA codes for orders.



DACIA

00



01



02



03



04



Silindir Kapak  
Cylinder Head  
Zylinderkopf  
Joint de culasse



Ltr	MODEL	PS/KW	ENGINE/MOTOR		
1,2 1149	4 CYL ø69 LOGAN 16V 2007-->	75 PS / 55 KW	D4DHIFLEX	<b>40108703</b> 77 01 475 822	 <b>40108605</b> 8200062273 MLS ø70
1,4 1390	4 CYL ø79,5 LOGAN SANDERO 09/04-->	75 PS / 55 KW 72 PS / 53 KW	K7J 710 K7J 714	<b>40108902</b> Motor Full Takım Gasket Full Set <b>40108903</b> 60 01 548 043  <b>40149004</b> Motor Alt Takım Conversion Set	 <b>40108905</b> 82 00 296 969 1,20mm FIBER / FIBRE  <b>40108906</b> 82 00 296 969 MLS ø80,5
1,5 1461	4 CYL ø76 LOGAN DCI 09/05-->	65 PS / 48 KW	K9K 790	<b>42456902</b> Motor Full Takım Gasket Full Set <b>42457003</b> 77 01 476 729  <b>42457104</b> Motor Alt Takım Conversion Set	 <b>42457005</b> 82 00 351 353 0,70mm  <b>42457006</b> 82 00 351 353 0,82mm MLS ø77,5
1,5 1461	4 CYL ø76 LOGAN DCI SANDERO DCI 01/06--> 09/07-->	68 PS / 50 KW 86 PS / 63 KW	K9K 792 K9K 796	<b>42457002</b> Motor Full Takım Gasket Full Set  <b>42457003</b> 77 01 476 729  <b>42457004</b> Motor Alt Takım Conversion Set	 <b>42457005</b> 82 00 351 353 0,70mm  <b>42457006</b> 82 00 351 353 0,82mm MLS ø77,5

▲ : İçerikte Bulunmamaktadır...

▲ : Not included in the set

▲ : Non inclus dans la pochette

00: Motor Takım Keçesiz ve Subap Lastiksiz

00: Gasket Set Without oil seals Without Valve Stem Seal











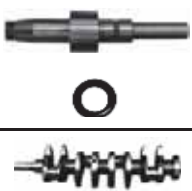







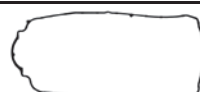

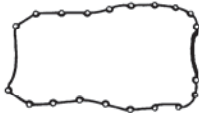

01: Motor Takım Keçesiz - Subap Lastikli

01: Gasket set With Valve Stem Seal Without Oil Seals

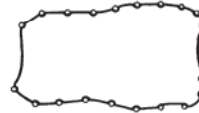
02: Motor Full Takım Keçeli ve Subap Lastikli

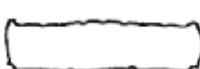
02: Gasket Full Set With oil seals and Valve Stem Seals

033

Subap Kapak Valve Cover Gasket Zylinderkopfhaube Couvre-culbut.	Karter Oil Pan Ölwanne Carter d'huile	Emme Manifold Intake Manifold Ansaug Admission	Egzoz Manifold Exhaust Manifold Auspuffkrümmer Collecteur D'echappement	Eksoz Boğaz Exhaust Pipe Auspuff Kehle	Supap Keçesi Valve Stem Seal Ventilschaft Queue de soupape	
						
 <b>40108725</b> 77 01 059 314		 <b>40108618</b> 77 01 473 007	 <b>40108621</b> 77 00 115 971		 <b>40108726x16</b> 82 00 171 215 5,5x8,3x11,5x8	<b>21204701</b> 28x47x8 RD
 <b>40116527</b> 77 01 471 719	 <b>42457165</b> 77 00 273 486	 <b>40108918x4</b> 77 01 471 932	 <b>40108921</b> 8200191371		 <b>40116026x8</b> 77 00 103 872 7x9,8/13.2x10	<b>21208003</b> 30x42x7 RD <b>21208001</b> 35x47x7 RD <b>21208012</b> 80x100x8 LD
 <b>42457125</b> 82 00 317 650	 <b>42457165</b> 77 00 273 486		 <b>42457021</b> 82 00 414 346		 <b>42457144x8</b> 77 00 109 840 6x8,8x12,2x9,7	<b>21204024</b> 28x42x5 RD <b>21204025</b> 35x47x7 RD <b>21204033</b> 80x100x9 LD
 <b>42457125</b> 82 00 317 650	 <b>42457065</b> 82 00 379 654		 <b>42457021</b> 82 00 414 346		 <b>42457144x8</b> 77 00 109 840 6x8,8x12,2x9,7	<b>21204024</b> 28x42x5 RD <b>21204025</b> 35x47x7 RD <b>21204033</b> 80x100x9 LD

■ : Delik - Çentik

■ : Hole - Notch

■ : Trou - Entaille

NOT: Katalogdaki Orijinal Kodlar Referans Amacıyla Kullanılmıştır.Lütfen Oto Conta Kodlarını Kullanınız.  
Original codes used for reference only.Please use OTO CONTA codes for orders.



DACIA

00



01



02



03



04



Silindir Kapak  
Cylinder Head  
Zylinderkopf  
Joint de culasse



Ltr	MODEL	PS/KW	ENGINE/MOTOR		
1,5 1461	4 CYL ø76 DUSTER 05/10--> LOGAN DCI SANDERO DCI DOKKER DCI 11/12-->	107 PS / 79 KW 75 PS / 55 KW	K9K 892 K9K 894 K9K 896 K9K 898 K9K 612	42457503 77 01 479 013	 42457505 11 04 470 55R 0,85mm MLS ø77,5
1,6 1598	4 CYL ø79,5 LOGAN 16V 02/06-->	105 PS / 77 KW	K4M 690 K4M 694	42456602 Motor Full Takım Gasket Full Set 42456603 77 01 471 886 42457204 Alt Takım Conversion Set	 42457205 77 00 112 739 MLS ø80,5
1,6 1598	4 CYL ø79,5 LOGAN 09/04--> SANDERO 06/08-->	105 PS / 77 KW 84 PS / 62 KW 87 PS / 62 KW	K7M 690 K7M 710 K7M 718 K7M 732	40108902 Motor Full Takım Gasket Full Set 40108903 60 01 548 043 40149004 Motor Alt Takım Conversion Set	 40108905 82 00 296 969 1,20mm FIBER / FIBRE 40108906 82 00 296 969 MLS ø80,5

▲ : İçerikte Bulunmamaktadır...

▲ : Not included in the set

▲ : Non inclus dans la pochette

00: Motor Takım Keçesiz ve Subap Lastiksiz























00: Gasket Set Without oil seals Without Valve Stem Seal

01: Motor Takım Keçesiz - Subap Lastikli

01: Gasket set With Valve Stem Seal Without Oil Seals

02: Motor Full Takım Keçeli ve Subap Lastikli

02: Gasket Full Set With oil seals and Valve Stem Seals

Subap Kapak Valve Cover Gasket Zylinderkopfhaube Couvre-culbut.	Karter Oil Pan Ölwanne Carter d'huile	Emme Manifold Intake Manifold Ansaug Admission	Egzoz Manifold Exhaust Manifold Auspuffkrümmer Collecteur D'echappement	Eksoz Boğaz Exhaust Pipe Auspuff Kehle	Supap Keçesi Valve Stem Seal Ventilschaft Queue de soupape	
						
						<b>21204710</b> 28x42x6 RD
<b>42457525</b> 77 01 070 607	<b>42457065</b> 82 00 379 654		<b>42457021</b> 82 00 414 346		<b>42457144x8</b> 77 00 109 840 82 00 496 321 6x8,8x12,2x9,7	<b>21204025</b> 35x47x7 RD <b>21204033</b> 80x100x9 LD
						<b>21204024x2</b> 28x42x5 RD
	<b>42457265</b> 77 00 103 687	<b>42457418x4</b> 82 00 275 057	<b>42457222</b> 82 00 365 915		<b>62457244x16</b> 77 00 103 938 5,5x11x28x16,4	<b>21204005</b> 35x47x7 RD <b>21204009</b> 80x100x8 LD
						
						<b>21208003</b> 30x42x7 RD
<b>40116527</b> 77 01 471 719	<b>42457165</b> 77 00 273 486	<b>40108918x4</b> 77 01 471 932	<b>40108921</b> 8200191371		<b>40116026x8</b> 77 00 103 872 7x9,8/13.2x10	<b>21208001</b> 35x47x7 RD <b>21208012</b> 80x100x8 LD

■ : Delik - Çentik

■ : Hole - Notch

■ : Trou - Entaille

NOT: Katalogdaki Orijinal Kodlar Referans Amacıyla Kullanılmıştır. Lütfen Oto Conta Kodlarını Kullanınız.  
Original codes used for reference only. Please use OTO CONTA codes for orders.



DAEWOO

00



01



02



03



04



Silindir Kapak  
Cylinder Head  
Zylinderkopf  
Joint de culasse



Ltr	MODEL	PS/KW	ENGINE/MOTOR		
0,8	3 CYL ø68,5 MATIZ TICO SPARK (SOHC )	01/96-->12/00 52 PS / 38 KW 48 PS / 35 KW	F8CV F8CV		 <b>41460105</b> 11141A78B01-00 2,00mm ø69,5
1,4 1349	4 CYL ø77,6 LANOS	05/97--> 75 PS / 55 KW	A13DM A14SMS A13SMS	<b>42447103</b> 1606730	 <b>42447205</b> 607449 1,80mm ø79,5
1,4 1393	4 CYL ø77,9 KALOS AVEO (SOHC )	1102-->12/04 83 PS / 61KW	F14S3		 <b>42447305</b> 5607408-607988 1,40mm ø80,5
1,4 1399	4 CYL ø77,9 KALOS OPTRA LACETTI ( DOCH16V )	10/03-->12/05 94 PS / 69 KW	F14D3 F14D5		 <b>42450205</b> 96378802 1,20mm FIBER / FIBRE ø80
1,4 1399	4 CYL ø77,9 AVEO LACETTI NUBIRA OPTRA KALOS (DOCH 16 V )	03/05-->12/07 94 PS / 69 KW	F14D3		 <b>42450105</b> 96473400 1,20mm FIBER / FIBRE ø80
1,5 1498	4 CYL ø76,5 ESPERO CIELO NEXIA ( DOCH 16V )	02/95-->06/99 90 PS / 6 KKW	A15MF		 <b>41504005</b> 96391435 1,40mm  <b>41504006</b> 96391435 2,00mm ø78

▲ : İçerikte Bulunmamaktadır...

▲ : Not included in the set

▲ : Non inclus dans la pochette

00: Motor Takım Keçesiz ve Subap Lastiksiz

00: Gasket Set Without oil seals Without Valve Stem Seal











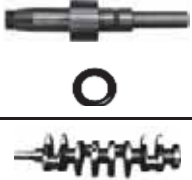

01: Motor Takım Keçesiz - Subap Lastikli

01: Gasket set With Valve Stem Seal Without Oil Seals

02: Motor Full Takım Keçeli ve Subap Lastikli

02: Gasket Full Set With oil seals and Valve Stem Seals

037

Subap Kapak Valve Cover Gasket Zylinderkopfhaube Couvre-culbut.	Karter Oil Pan Ölwanne Carter d'huile	Emme Manifold Intake Manifold Ansaug Admission	Egzoz Manifold Exhaust Manifold Auspuffkrümmer Collecteur D'echappement	Eksoz Boğaz Exhaust Pipe Auspuff Kehle	Supap Keçesi Valve Stem Seal Ventilschaft Queue de soupape	
						
						
<b>42447236</b> 638 260 Kauçuk Rubber		<b>42447319</b> 850 607	<b>42447221</b> 850 615		<b>42447227x8</b> 642527 7x11,1/16x10	<b>21201014</b> 35x48x7 RD

■ : Delik - Çentik

■ : Hole - Notch

■ : Trou - Entaille

NOT: Katalogdaki Orijinal Kodlar Referans Amacıyla Kullanılmıştır.Lütfen Oto Conta Kodlarını Kullanınız.  
Original codes used for reference only.Please use OTO CONTA codes for orders.



DAEWOO

00



01



02



03



04



Silindir Kapak  
Cylinder Head  
Zylinderkopf  
Joint de culasse



Ltr	MODEL	PS/KW	ENGINE/MOTOR		
1,5 1498	4 CYL ø77,6 LACETTI 04/97--> LANOS NUBIRA	110 PS / 81 KW 86 PS / 63 KW	A15DMS A15SMS	42447103 1606730	 42447205 607449 1,80mm ø79,5
1,5 1498	4 CYL ø79 NEXIA 07/94-->08/97 ESPERO CIELO LEMANS	78 PS / 57 KW 60 PS / 44 KW	G15MF 16SV	42447302 Motor Full Takım Gasket Full Set 42447303 1606673+1606689 42447204 1606728+1606686	 42447305 5607408-607988 1,40mm ø80,5
1,6 1598	4 CYL ø79 AVEO 07/03-->03/05 KALOS NUBIRA OPTRA LACETTI ( DOCH 16V )	109 PS / 80 KW	F16D3		 42450205 96378802 1,20mm FIBER / FIBRE ø80
1,8 1796	4 CYL ø84,8 ESPERO 02/95-->07/03 LACETTI 08/92-->08/95 LEGANZA SUPER SALOON PRINCE ARANOS (SOHC )	95 PS / 70 KW 90 PS / 60 KW 101 PS / 70 KW	C18LE S 18 NV	42447502 Motor Full Takım Gasket Full Set 42447503 1606666 42447504 1606663	 42447505 607986 1,40mm ø86,3
1,8 1799	4 CYL ø81,6 LACETTI 16 V 07/03--> NUBIRA 16 V	122 PS / 90 KW	T18SED	42448603 1606914	 42448605 608809 1,40mm ø83

▲ : İçerikte Bulunmamaktadır...

▲ : Not included in the set

▲ : Non inclus dans la pochette

00: Motor Takım Keçesiz ve Subap Lastiksiz



















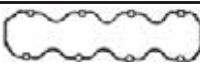









00: Gasket Set Without oil seals Without Valve Stem Seal

01: Motor Takım Keçesiz - Subap Lastikli

01: Gasket set With Valve Stem Seal Without Oil Seals

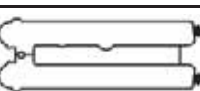
02: Motor Full Takım Keçeli ve Subap Lastikli

02: Gasket Full Set With oil seals and Valve Stem Seals

Subap Kapak Valve Cover Gasket Zylinderkopfhaube Couvre-culbut.	Karter Oil Pan Ölwanne Carter d'huile	Emme Manifold Intake Manifold Ansaug Admission	Egzoz Manifold Exhaust Manifold Auspuffkrümmer Collecteur D'echappement	Eksoz Boğaz Exhaust Pipe Auspuff Kehle	Supap Keçesi Valve Stem Seal Ventilschaft Queue de soupape	
						
 <b>42447236</b> 638 260 Kauçuk Rubber		 <b>42447319</b> 850 607	 <b>42447221</b> 850 615		 <b>42447227x8</b> 642527 7x11,1/16x10	<b>21201014</b> 35x48x7 RD
 <b>42447235</b> 638727	 <b>42447265</b> 652577	 <b>42447219</b> 850634	 <b>42447221</b> 850 615	 <b>42447517</b> 854933	 <b>42447227x8</b> 642527 7x11,1/16x10	<b>21201014</b> 35x48x7 RD <b>21208007</b> 26x42x8 RD <b>21208013</b> 80x98x10 LD
 <b>42447534</b> 638192	 <b>42447564</b> 652587	 <b>42447518</b> 850600  <b>42447719</b> 850601	 <b>42447521</b> 850645	 <b>42447517</b> 854933	 <b>42447227x8</b> 642527 7x11,1/16x10	<b>21201014</b> 35x48x7 RD <b>21208020</b> 31x50x8 RD <b>21208019</b> 90x104x11 LD
 <b>42447625</b> 607647		 <b>42447619</b> 850655	 <b>42447621</b> 850656	 <b>42447517</b> 854933	 <b>42447426x16</b> 6x8,8x12,2x9,7	<b>21201014</b> 35x48x7 RD 2x

■ : Delik - Çentik

■ : Hole - Notch

■ : Trou - Entaille

NOT: Katalogdaki Orijinal Kodlar Referans Amacıyla Kullanılmıştır.Lütfen Oto Conta Kodlarını Kullanınız.  
Original codes used for reference only.Please use OTO CONTA codes for orders.



DAEWOO

00



Silindir Kapak  
Cylinder Head  
Zylinderkopf  
Joint de culasse

01



02



03



04



Ltr	MODEL	PS/KW	ENGINE/MOTOR		
2,0 1998	4 CYL ø86 ESPERO 10/93-->06/99 LEGANZA LEMANS RACER PRINCE MAGNUS COMPACT ARANOS NUBIRA II (SOHC )	110 PS / 81 KW 105 PS / 77 KW	C20LE C20NE	<b>462447700</b>  <b>42447702</b> Motor Full Takım Gasket Full Set <b>42447703</b> 1606664  <b>42447504</b> 1606663	 <b>42447705</b> 607987 1,30mm  <b>ø87,5</b>
2,0 1998	4 CYL ø86 LEGANZA 16 V 05/97--> NUBIRA II 16 V 07/00--> LACETTI 16 V MAGNUS 16 V REZZO 16 V (DOHC )	126 PS / 93 KW 133 PS / 98 KW 121 PS / 89 KW	T20SED X 20 SED Z20L X22SED	<b>42447603</b> 1606770	 <b>42447605</b> 5607449 1,30mm  <b>ø87,5</b>

▲ : İçerikte Bulunmamaktadır...

▲ : Not included in the set

▲ : Non inclus dans la pochette

00: Motor Takım Keçesiz ve Subap Lastiksiz



















00: Gasket Set Without oil seals Without Valve Stem Seal

01: Motor Takım Keçesiz - Subap Lastikli

01: Gasket set With Valve Stem Seal Without Oil Seals

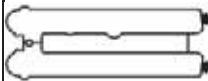
02: Motor Full Takım Keçeli ve Subap Lastikli

02: Gasket Full Set With oil seals and Valve Stem Seals

Subap Kapak Valve Cover Gasket Zylinderkopfhaube Couvre-culbut.	Karter Oil Pan Ölwanne Carter d'huile	Emme Manifold Intake Manifold Ansaug Admission	Egzoz Manifold Exhaust Manifold Auspuffkrümmer Collecteur D'echappement	Eksoz Boğaz Exhaust Pipe Auspuff Kehle	Supap Keçesi Valve Stem Seal Ventilschaft Queue de soupape	
						
 <b>42447534</b> 638192	 <b>42447564</b> 652587	 <b>42447719</b> 850601	 <b>42447521</b> 850645	 <b>42447517</b> 854933	 <b>42447227x8</b> 642527 7x11,1/16x10	<b>21201014</b> 35x48x7 RD
 <b>42447625</b> 607647		 <b>42447619</b> 850655	 <b>42447621</b> 850656		 <b>42447426x16</b> 642533 6x8.8x12.2x9.7	<b>21208020</b> 31x50x8 RD
						<b>21208019</b> 90x104x11 LD
						<b>21201014x2</b> 35x48x7 RD

■ : Delik - Çentik

■ : Hole - Notch

■ : Trou - Entaille

NOT: Katalogdaki Orijinal Kodlar Referans Amacıyla Kullanılmıştır.Lütfen Oto Conta Kodlarını Kullanınız.  
Original codes used for reference only.Please use OTO CONTA codes for orders.



DAIHATSU

00



Silindir Kapak  
Cylinder Head

01



Zylinderkopf

02



Joint de culasse

03



04



Ltr	MODEL	PS/KW	ENGINE/MOTOR	
1,0 993	3 CYL ø76 CHARADE 03/87-->12/92	52 PS / 38 KW	CB12 CB23 CB37 CBT50	 <b>41460005</b> 11115-87714 1,80mm ø77,5
1,6 1587	4 CYL ø80,5 DELTA TAFT 09/72-->02/85	67 PS / 49 KW	12R	 <b>41411505</b> 11115-31020 1,80mm <b>41411506</b> 11115-31020 2,0mm ø83
1,8 1812	4 CYL ø86 DELTA WIDE 02/85-->	88 PS / 65 KW	2Y	 <b>41411605</b> 11115-71010 1,80mm <b>41411606</b> 11115-71010 2,0mm ø88
2,0 1998	4 CYL ø86 DELTA WIDE ROCKY RUGGER TAFT 02/85-->04/93	88 PS / 65 KW	3Y	 <b>41411605</b> 11115-71010 1,80mm <b>41411606</b> 11115-71010 2,0mm ø88
2,2 2237	4 CYL ø91 ROCKY 05/93-->06/01	88 PS / 65 KW	4Y	 <b>41411105</b> 11115-73010 1,60mm <b>41411106</b> 11115-73010 2,00mm ø93

▲ : İçerikte Bulunmamaktadır...

▲ : Not included in the set

▲ : Non inclus dans la pochette

00: Motor Takım Keçesiz ve Subap Lastiksiz











00: Gasket Set Without oil seals Without Valve Stem Seal

01: Motor Takım Keçesiz - Subap Lastikli

01: Gasket set With Valve Stem Seal Without Oil Seals

02: Motor Full Takım Keçeli ve Subap Lastikli

02: Gasket Full Set With oil seals and Valve Stem Seals

Subap Kapak Valve Cover Gasket Zylinderkopfhaube Couverculbut.	Karter Oil Pan Ölwanne Carter d'huile	Emme Manifold Intake Manifold Ansaug Admission	Egzoz Manifold Exhaust Manifold Auspuffkrümmer Collecteur D'echappement	Eksoz Boğaz Exhaust Pipe Auspuff Kehle	Supap Keçesi Valve Stem Seal Ventilschaft Queue de soupape	  
						
		 <b>41415720</b> 17172-71010				
		 <b>41415720</b> 17172-71010				

■ : Delik - Çentik

■ : Hole - Notch

■ : Trou - Entaille

NOT: Katalogdaki Orijinal Kodlar Referans Amacıyla Kullanılmıştır.Lütfen Oto Conta Kodlarını Kullanınız.  
 Original codes used for reference only.Please use OTO CONTA codes for orders.



FIAT

00



Silindir Kapak  
Cylinder Head

01



Zylinderkopf

02



Joint de culasse

03



04



Ltr	MODEL	PS/KW	ENGINE/MOTOR		
0,8 767	<b>4 CYL ø62</b> <b>600 D</b> 10/60-->02/70 <b>600 E</b> <b>600 T</b> <b>770 S</b> 10/60-->08/68  2 Serie Furgoneta	23 PS / 17 KW  25 PS / 18 KW	100 D.000  100 D.000	<b>43113002</b> 588041+4387608  <b>43113000</b> 588041	 <b>43113005</b> 4387608 1,20mm  <b>43113006</b> 4064640 1,80mm <b>ø64</b>
0,8 843	<b>4 CYL ø65</b> <b>850</b> 07/64-->10/72 <b>850 VAN</b> 03/68-->10/72  Furgoneta Special T Familiare Van	35 PS / 25 KW 48 PS / 35 KW	100 G.000 100 G.000	<b>40313002</b> 5880412 5881112  <b>40313000</b> 5880412 5881112	 <b>40313005</b> 7745836 1,20mm  <b>40313006</b> 7539220 1,80mm <b>ø66</b>
0,9 903	<b>4 CYL ø65</b> <b>850</b> 02/68-->12/72 <b>900 E</b> 01/78-->01/86 <b>900 T</b> 01/78-->01/86  Panorama Pulmino Spider Sport Coupe T Familiare	32 PS / 24 KW 52 PS / 38 KW 35 PS / 26 KW	100 G.000 100 G.000 100 G.000	<b>40313002</b> 5880412 5881112  <b>40313000</b> 5880412 5881112	 <b>40313005</b> 7745836 1,20mm  <b>40313006</b> 7539220 1,80mm <b>ø66</b>
0,9 903	<b>4 CYL ø65</b> <b>127 ESPECIAL</b> 1974--> <b>PANDA 34</b> 10/1980-->06/1994 <b>PANDA 35</b> 10/1980-->06/1994 <b>PANDA 4x2</b> 10/1980-->06/1994 <b>UNO 45</b> 1988--> <b>PANDA</b> 10/80-->06/94	34 PS / 25 KW 45 PS / 33 KW	146 A.000 146 A.048 100 CL3.000		 <b>40313005</b> 7745836 1,20mm  <b>40313006</b> 7539220 1,80mm <b>ø66</b>

▲ : İçerikte Bulunmamaktadır...

▲ : Not included in the set

▲ : Non inclus dans la pochette

00: Motor Takım Keçesiz ve Subap Lastiksiz

00: Gasket Set Without oil seals Without Valve Stem Seal

















01: Motor Takım Keçesiz - Subap Lastikli

01: Gasket set With Valve Stem Seal Without Oil Seals

02: Motor Full Takım Keçeli ve Subap Lastikli

02: Gasket Full Set With oil seals and Valve Stem Seals

045

Subap Kapak Valve Cover Gasket Zylinderkopfhaube Couvre-culbut.	Karter Oil Pan Ölwanne Carter d'huile	Emme Manifold Intake Manifold Ansaug Admission	Egzoz Manifold Exhaust Manifold Auspuffkrümmer Collecteur D'echappement	Eksoz Boğaz Exhaust Pipe Auspuff Kehle	Supap Keçesi Valve Stem Seal Ventilschaft Queue de soupape	
						
 40313034 4145587	 40313013 5882343	 40313020 4127971				21201064 42x56x7 LD 21201065 64x80x8 RD
 40313034 4145587	 40313013 5882343	 40313020 4127971				21201064 42x56x7 LD 21201065 64x80x8 RD
 40313034 4145587	 40313013 5882343	 40313020 4127971				21201064 42x56x7 LD 21201065 64x80x8 RD

■ : Delik - Çentik

■ : Hole - Notch

■ : Trou - Entaille

NOT: Katalogdaki Orijinal Kodlar Referans Amacıyla Kullanılmıştır.Lütfen Oto Conta Kodlarını Kullanınız.  
Original codes used for reference only.Please use OTO CONTA codes for orders.



FIAT

00



01



02



03



04



Silindir Kapak  
Cylinder Head  
Zylinderkopf  
Joint de culasse



Ltr	MODEL	PS/KW	ENGINE/MOTOR		
1.0 999	<b>4 CYL ø70</b> PANDA 01/86-->12/92 PANDA 1000 05/86-->03/95 PANDA 45 05/86-->03/95 UNO 45 05/86-->03/95 45 Fire SPI	45 PS / 33 KW 50 PS / 37 KW 45 PS / 33 KW	156 A2.000 156 A2.100 156 A2.146 141 C2.000 156 A3.000 156 A3.100 156 A2.246 156.A2.048 146.A2.166 146.D8.000	<b>40340102</b> 5892376 <b>40340100</b> 5892376 <b>40340103</b> 5882345	 <b>40340005</b> 7640784 1,80mm <b>ø71,5</b>
1.0 1049	<b>4 CYL ø76</b> 127 09/71-->02/82 127 09/79-->02/82 FIORINO RITMO STRADA 60 No:475521-->	70 PS / 51 KW 60 PS / 44 KW	127 A1.000 127 A6.000 127 A.000	<b>43114002</b> 5891802 5891843 <b>43114000</b> 5891802 5891843	 <b>43114005</b> 5960967 1,20mm <b>43114006</b> 5960968 1,80mm <b>ø77</b>
1.0 1049	<b>4 CYL ø76</b> 127 09/71-->02/82 127 09/79-->02/82 FIORINO RITMO STRADA 60 No:475520 <--	70 PS / 51 KW 60 PS / 44 KW	127 A1.000 127 A6.000 127 A.000	<b>43114102</b> 5882059 <b>43114100</b> 5882059	 <b>43114005</b> 5960967 1,20mm <b>43114006</b> 5960968 1,80mm <b>ø77</b>
1.1 1108	<b>4 CYL ø70</b> TIPO 01/89-->09/99 UNO 01/89-->09/99 PANDA 10/94-->01/98 PUNTO 55 01/93-->09/99 CINQUENTO 10/94-->01/98 SEICENTO 01/95-->	54 PS / 40 KW 49 PS / 36 KW	160 A3.000 176 A6.000 176 B2.000 156 C.046 146 C3.000 156 B2.000 178 B9.033	<b>40340002</b> 5893658 <b>40340001</b> 5893658 <b>40340003</b> 5888218	 <b>40340005</b> 7640784 1,80mm <b>ø71,5</b>

▲ : İçerikte Bulunmamaktadır...

▲ : Not included in the set

▲ : Non inclus dans la pochette

00: Motor Takım Keçesiz ve Subap Lastiksiz

























00: Gasket Set Without oil seals Without Valve Stem Seal

01: Motor Takım Keçesiz - Subap Lastikli

01: Gasket set With Valve Stem Seal Without Oil Seals

02: Motor Full Takım Keçeli ve Subap Lastikli

02: Gasket Full Set With oil seals and Valve Stem Seals

Subap Kapak Valve Cover Gasket Zylinderkopfhaube Couvre-culbut.	Karter Oil Pan Ölwanne Carter d'huile	Emme Manifold Intake Manifold Ansaug Admission	Egzoz Manifold Exhaust Manifold Auspuffkrümmer Collecteur D'echappement	Eksoz Boğaz Exhaust Pipe Auspuff Kehle	Supap Keçesi Valve Stem Seal Ventilschaft Queue de soupape	
						
 <b>40340025</b> 7688450		 <b>40340119</b> 7597583	 <b>40340120x4</b> 7579740		 <b>40116026x8</b> 5930415 7x9,8/13.2x10	<b>21208003</b> 30x42x7 RD
						<b>21201072</b> 23x35x7 RD
						<b>21201053</b> 70x88x8 LD
 <b>43114034</b> 4323710	 <b>43114013</b> 4249510	 <b>43114020x2</b> 4398359			 <b>40107027x8</b> 7553637 8x10,8x14,2x10	<b>21201006</b> 30x52x7 RD
						<b>21201017</b> 40x56x7 RD
						<b>21201063</b> 70x85x8 LD
 <b>43114034</b> 4323710	 <b>43114013</b> 4249510	 <b>43114020x2</b> 4398359			 <b>40107027x8</b> 7553637 8x10,8x14,2x10	<b>21201006</b> 30x52x7 RD
						<b>21201017</b> 40x56x7 RD
						<b>21201030</b> 64x80x8 LD
 <b>40340025</b> 7688450		 <b>40340019</b> 46426046 46754320	 <b>40340020x2</b> 7749711		 <b>40116026x8</b> 5930415 7x9,8/13.2x10	<b>21208003</b> 30x42x7 RD
						<b>21201072</b> 23x35x7 RD
						<b>21201053</b> 70x88x8 LD

■ : Delik - Çentik

■ : Hole - Notch

■ : Trou - Entaille

NOT: Katalogdaki Orijinal Kodlar Referans Amacıyla Kullanılmıştır.Lütfen Oto Conta Kodlarını Kullanınız.  
Original codes used for reference only.Please use OTO CONTA codes for orders.



FIAT

00



01



02



03



04



Silindir Kapak  
Cylinder Head  
Zylinderkopf  
Joint de culasse



Ltr	MODEL	PS/KW	ENGINE/MOTOR		
1,1 1108	<b>4 CYL ø70</b> PANDA 02/95-->09/03 PANDA 4x2 09/03--> PANDA 4x4 09/03--> SEICENTO 01/98-->01/10	54 PS / 40 KW	187 A.1.000	<b>40340402</b> 71716869 <b>40340401</b> 71716869 <b>40340403</b> 71718390	 <b>40340005</b> 7640784 1,80mm <b>ø71,5</b>
1,1 1108	<b>4 CYL ø70</b> PANDA 02/95-->07/04 PALIO TIPO 01/88-->10/91 UNO 60 04/89-->12/92  Fire SPI	50 PS / 37 KW 54 PS / 40 KW 56 PS / 41 KW 57 PS / 42 KW	145 C.046 176 B2.000 178 B9.033 160 A.3000	<b>40340102</b> 5892376 <b>40340100</b> 5892376 <b>40340103</b> 5882345	 <b>40340005</b> 7640784 1,80mm <b>ø71,5</b>
1,1 1116	<b>4 CYL ø80</b> 128 03/69-->12/84 RITMO 60 1978-->1982 STRADA 1979-->1982  60 L-CL Pick-Up Todos Tipos Motor All Engine Types Tous Types de Moteur	55 PS / 40 KW 60 PS / 44 KW 45 PS / 33 KW	128 A 138 A.000 128 AC5.000 128 A.048	<b>40306002</b> 5881135 <b>40306000</b> 5881135	 <b>40306005</b> 4387618 1,20mm <b>ø81</b>
1,1 1116	<b>4 CYL ø80</b> 128 03/69-->12/84 RITMO 60 1978-->1982 STRADA 1979-->1982  60 L-CL Pick-Up Todos Tipos Motor All Engine Types Tous Types de Moteur	55 PS / 40 KW 60 PS / 44 KW 45 PS / 33 KW	128 A 138 A.000 128 AC5.000 128 A.048	<b>40306102</b>  <b>40306100</b>	 <b>40306006</b> 4406740 1,80mm <b>ø81</b>
1,2 1197	<b>4 CYL ø73</b> 124 02/73-->07/75  Berlina	65 PS / 48 KW	124 A.000	<b>40301002</b> 5880424	 <b>40301005</b> 4387614 1,20mm <b>ø78</b>

▲ : İçerikte Bulunmamaktadır...

▲ : Not included in the set

▲ : Non inclus dans la pochette

00: Motor Takım Keçesiz ve Subap Lastiksiz











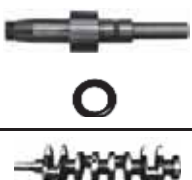









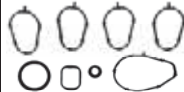











00: Gasket Set Without oil seals Without Valve Stem Seal

01: Motor Takım Keçesiz - Subap Lastikli

01: Gasket set With Valve Stem Seal Without Oil Seals

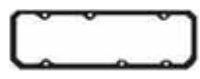
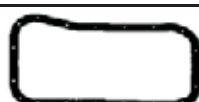
02: Motor Full Takım Keçeli ve Subap Lastikli

02: Gasket Full Set With oil seals and Valve Stem Seals

Subap Kapak Valve Cover Gasket Zylinderkopfhaube Couvre-culbut.	Karter Oil Pan Ölwanne Carter d'huile	Emme Manifold Intake Manifold Ansaug Admission	Egzoz Manifold Exhaust Manifold Auspuffkrümmer Collecteur D'échappement	Eksoz Boğaz Exhaust Pipe Auspuff Kehle	Supap Keçesi Valve Stem Seal Ventilschaft Queue de soupape	
						 
 <b>40340025</b> 7688450		 <b>40340418</b> 71716684	 <b>40340020x2</b> 7749711		 <b>40116026x8</b> 5930415 7x9,8/13.2x10	<b>21208003</b> 30x42x7 RD <b>21201072</b> 23x35x7 RD <b>21204081</b> 74x88x8 LD
 <b>40340025</b> 7688450		 <b>40340119</b> 7597583	 <b>40340120x4</b> 7579740		 <b>40116026x8</b> 5930415 7x9,8/13.2x10	<b>21208003</b> 30x42x7 RD <b>21201072</b> 23x35x7 RD <b>21201053</b> 70x88x8 LD
 <b>40304034</b> 4448677  <b>40304035</b> 7784728	 <b>40306013</b> 4179038	 <b>40306020x2</b> 4309031		 <b>40301018</b> 4147260	 <b>40107027x8</b> 7553637 8x10,8x14,2x10	<b>21201006</b> 30x52x7 RD <b>21201017</b> 40x56x7 RD <b>21201030</b> 64x80x8 LD
 <b>40304034</b> 4448677  <b>40304035</b> 7784728	 <b>40306013</b> 4179038	 <b>40306020x2</b> 4309031		 <b>40301018</b> 4147260	 <b>40107027x8</b> 7553637 8x10,8x14,2x10	<b>21201006</b> 30x52x7 RD <b>21201017</b> 40x56x7 RD <b>21201030</b> 64x80x8 LD
 <b>40301034</b> 4130541	 <b>40301013</b> 4129756	 <b>40301020x2</b> 4177631		 <b>40301018</b> 4147260	 <b>40107027x8</b> 7553637 8x10,8x14,2x10	<b>21201006</b> 30x52x7 RD <b>21201017</b> 40x56x7 LD <b>21201066</b> 70x90x10 RD

■ : Delik - Çentik

■ : Hole - Notch

■ : Trou - Entaille

NOT: Katalogdaki Orijinal Kodlar Referans Amacıyla Kullanılmıştır.Lütfen Oto Conta Kodlarını Kullanınız.  
Original codes used for reference only.Please use OTO CONTA codes for orders.



FIAT

00



01



02



03



04



Silindir Kapak  
Cylinder Head  
Zylinderkopf  
Joint de culasse



Ltr	MODEL	PS/KW	ENGINE/MOTOR		
1,2 1242	<b>4 CYL ø70,8</b> PUNTO 60 01/94-->09/99 PUNTO SELECT/ 01/94-->09/99 PUNTO 75 11/93--> PALIO 75 01/94-->09/99 SIENA 04/96--> PUNTO 60 CABRIO	58 PS / 43 KW 73 PS / 54 KW 75 PS / 55 KW 60 PS / 44 KW	176 A7.000 176 A8.000 176 B1.000 176 A7.000 176 B4.000	<b>40340202</b> 5893660 <b>40340201</b> 5893660 <b>40340203</b> 5893663 5893661	 <b>40340005</b> 7640784 1,80mm <b>ø71,5</b>
1,2 1242	<b>4 CYL ø70,8</b> PUNTO 16V 1997-->1999 MAREA 16V 1999--> PUNTO CABRIO 16 V BRAVA 12/98-->10/00 BRAVO 12/98-->10/00 STILO 02/02--> Active Dynamic	86 PS / 63 KW 82 PS / 60 KW	182 B2.000 176 B9.000 182 A2.000		 <b>42427907</b> 46434596 1,80mm <b>ø72</b>
1,2 1242	<b>4 CYL ø70,8</b> BRAVA 16V 10/00-->10/01 BRAVO 16V 10/00-->10/01 IDEA 16V 09/99--> PUNTO 16V 10/97-->09/99 STILO 16V 09/99-->	80 PS / 59 KW 82 PS / 60 KW	188 A5.000 176 B9.000	<b>40340302</b> 71716871	 <b>42427907</b> 46434596 1,80mm <b>ø72</b>
1,2 1242	<b>4 CYL ø70,8</b> PUNTO 09/99--> DOBLO 03/01--> PANDA 09/03--> STRADA 10/99-->03/03	60 PS / 44 KW 65 PS / 48 KW	188 A4.000 223 A5.000	<b>40340402</b> 71716869 71728827 <b>40340401</b> 71716869 71728827 <b>40340403</b> 71718390	 <b>40340005</b> 7640784 1,80mm <b>ø71,5</b>
1,2 1242	<b>4 CYL ø70,8</b> PALIO 02/01--> DOBLO 03/01--> ALBEA 09/01--> PUNTO 09/99--> PANDA 09/99-->	60 PS / 44 KW 65 PS / 48 KW 60 PS / 44 KW	188 A4.000 199 A4.000 223 A5.000 178 B7.045 178 C4.066	<b>42428102</b> 71716869 <b>42428103</b> 71736240	 <b>42428005</b> 55183371 MLS <b>ø72</b>

▲ : İçerikte Bulunmamaktadır...

▲ : Not included in the set

▲ : Non inclus dans la pochette

00: Motor Takım Keçesiz ve Subap Lastiksiz











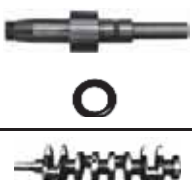











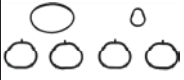

00: Gasket Set Without oil seals Without Valve Stem Seal

01: Motor Takım Keçesiz - Subap Lastikli

01: Gasket set With Valve Stem Seal Without Oil Seals

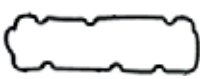
02: Motor Full Takım Keçeli ve Subap Lastikli

02: Gasket Full Set With oil seals and Valve Stem Seals

Subap Kapak Valve Cover Gasket Zylinderkopfhaube Couvre-culbut.	Karter Oil Pan Ölwanne Carter d'huile	Emme Manifold Intake Manifold Ansaug Admission	Egzoz Manifold Exhaust Manifold Auspuffkrümmer Collecteur D'echappement	Eksoz Boğaz Exhaust Pipe Auspuff Kehle	Supap Keçesi Valve Stem Seal Ventilschaft Queue de soupape	
						
 <b>40340025</b> 7688450		 <b>40340019</b> 46426046 46754320  <b>40340018</b> 46432735	 <b>40340020x2</b> 7749711	 <b>40340017</b> 7706480	 <b>40116026x8</b> 5930415 7x9,8/13.2x10	<b>21208003</b> 30x42x7 RD <b>21201072</b> 23x35x7 RD <b>21204081</b> 74x88x8 LD
 <b>42427925</b> 55194045		 <b>42427918</b> 71729223	 <b>42427921</b> 7749710		 <b>42427426x16</b> 46470334 6x8,8x11,7x9,5	<b>21208048</b> 27x37x7 RD <b>21208049</b> 40x55x7 RD
 <b>40340025</b> 7688450		 <b>40340418</b> 71716684	 <b>40340020x2</b> 7749711		 <b>40116026x8</b> 5930415 7x9,8/13.2x10	<b>21208003</b> 30x42x7 RD <b>21201072</b> 23x35x7 RD <b>21204081</b> 74x88x8 LD
 <b>40340027</b>		 <b>40340418</b> 71716684	 <b>40340020x2</b> 7749711		 <b>40116026x8</b> 5930415 7x9,8/13.2x10	<b>21208003</b> 30x42x7 RD <b>21201072</b> 23x35x7 RD <b>21208041</b> 74x88x8 LD

■ : Delik - Çentik

■ : Hole - Notch

■ : Trou - Entaille

NOT: Katalogdaki Orijinal Kodlar Referans Amacıyla Kullanılmıştır.Lütfen Oto Conta Kodlarını Kullanınız.  
Original codes used for reference only.Please use OTO CONTA codes for orders.



FIAT

00



01



02



03



04



Silindir Kapak  
Cylinder Head  
Zylinderkopf  
Joint de culasse



Ltr	MODEL	PS/KW	ENGINE/MOTOR		
1,2 1242	<b>4 CYL ø70,8</b> PALIO 06/98--> PUNTO 03/94-->09/99 PUNTO 03/94-->09/99 PUNTO 11/99--> PUNTO 60 08/95--> PUNTO 75 04/96--> SIENA 04/96--> CABRIO 05/95-->06/00 Fire SPI Inyección	73 PS / 54 KW 60 PS / 44 KW 60 PS / 44 KW 73 PS / 54 KW 60 PS / 44 KW 73 PS / 53 KW 73 PS / 53 KW 60 PS / 44 KW	178 E2.000 176 B1.000 176 B4.000 176 A8.000 176 B4.000 178 B5.000 176 B5.000 176 B4.000	<b>40340202</b> 5893660 <b>40340201</b> 5893660 <b>40340203</b> 5893663 5893661	 <b>40340005</b> 7640784 1,80mm <b>ø71,5</b>
1,2 1242	<b>4 CYL ø70,8</b> PALIO 02/02--> SIENA 02/02--> BRAVA 10/00-->10/01 BRAVO 10/00-->10/01 IDEA 09/99--> PUNTO 09/99--> STILO 09/99-->	80 PS / 59 KW 80 PS / 59 KW 80 PS / 59 KW 80 PS / 59 KW 80 PS / 59 KW 80 PS / 59 KW 80 PS / 59 KW	178 D7.055 178 D7.055 188 A5.000 188 A5.000 188 A5.000 188 A5.000 188 A5.000	<b>42427902</b> Motor Full Takım Gasket Full Set <b>42427903</b> 71739160	 <b>42427905</b> 55197283 MLS <b>ø72</b>
1,2 1242	<b>4 CYL ø70,8</b> PANDA 10/07--> PANDA (169) PUNTO / GRANDE PUNTO PUNTO EVO 500 500 C	69 PS / 51 KW	169 A.4000	<b>42428002</b> Motor Full Takım Gasket Full Set <b>42428003</b> 71740655 <b>42428004</b> 71728839	 <b>42428005</b> 55183371 MLS <b>ø72</b>
1,3 125	<b>4 CYL ø72</b> 1961-->1966			<b>43110002</b> Motor Full Takım Gasket Full Set <b>43110000</b>	 <b>43110005</b> 1,20mm <b>43110006</b> 1,80mm <b>ø76</b>

▲ : İçerikte Bulunmamaktadır...

▲ : Not included in the set

▲ : Non inclus dans la pochette

00: Motor Takım Keçesiz ve Subap Lastiksiz

00: Gasket Set Without oil seals Without Valve Stem Seal



























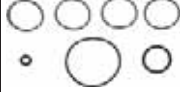

01: Motor Takım Keçesiz - Subap Lastikli

01: Gasket set With Valve Stem Seal Without Oil Seals

02: Motor Full Takım Keçeli ve Subap Lastikli

02: Gasket Full Set With oil seals and Valve Stem Seals

053

Subap Kapak Valve Cover Gasket Zylinderkopfhaube Couvre-culbut.	Karter Oil Pan Ölwanne Carter d'huile	Emme Manifold Intake Manifold Ansaug Admission	Egzoz Manifold Exhaust Manifold Auspuffkrümmer Collecteur D'echappement	Eksoz Boğaz Exhaust Pipe Auspuff Kehle	Supap Keçesi Valve Stem Seal Ventilschaft Queue de soupape	
						
 <b>40340025</b> 7688450		 <b>40340019</b> 46426046 46754320	 <b>40340020x2</b> 7749711	 <b>40340017</b> 7706480	 <b>40116026x8</b> 5930415 7x9,8/13.2x10	<b>21208003</b> 30x42x7 RD
		 <b>40340018</b> 46432735				<b>21201072</b> 23x35x7 RD
						<b>21204081</b> 74x88x8 LD
 <b>42427925</b> 55194045		 <b>42427918</b> 71729223	 <b>42427921</b> 46526271		 <b>42427426x16</b> 46470334 6x8,8x11,7x9,5	<b>21208048</b> 27x37x7 RD
						<b>21208049</b> 40x55x7
 <b>42428025</b> 71740678	 <b>42427465</b>	 <b>42428019</b> 77363787	 <b>42428020</b> 55199355		 <b>42428027x8</b> 55190344 5x7,8/11x8	<b>21208049</b> 40x55x7
						<b>21208048</b> 27x37x7 RD
						<b>21208050</b> 74x88x8 LD
 <b>40305034</b> 4027732	 <b>40305013</b> 902072	 <b>40305018x2</b> 4086677	 <b>40305020</b> 4072291	 <b>40305017</b> 4061096		<b>21201070</b> 45x62x8
						<b>21201071</b> 80x100x10

■ : Delik - Çentik

■ : Hole - Notch

■ : Trou - Entaille

NOT: Katalogdaki Orijinal Kodlar Referans Amacıyla Kullanılmıştır.Lütfen Oto Conta Kodlarını Kullanınız.  
Original codes used for reference only.Please use OTO CONTA codes for orders.



FIAT

00



01



02



03











04



Silindir Kapak  
Cylinder Head  
Zylinderkopf  
Joint de culasse



Ltr	MODEL	PS/KW	ENGINE/MOTOR		
1,3 1242	4 CYL ø69,6 DOBLO 06/03--> DOBLO D DOBLO JTD 16V FIORINO GRANDE PUNTO D GRANDE PUNTO (199) IDEA JTD PALIO PANDA PANDA JTD PUNTO PUNTO EVO PUNTO JTD 16V SIENA 500 500 C DOBLO 10/05--> DOBLO D GRANDE PUNTO D IDEA LINEA PUNTO / GRANDE PUNTO PUNTO EVO STRADA	75 PS / 55 KW 69 PS / 51 KW              90 PS / 66 KW 84 PS / 62 KW	169 A1.000 188 A9.000 199 A2.000              199 A3.000 223 A9.000	<b>42427402</b> Motor Full Takım Gasket Full Set   <b>42427403</b> 71729499 71744288  <b>42427404</b> 71736913 71744287 	 <b>42427505</b> 55209070 <b>0,72mm</b>  <b>42427506</b> 55209071 0,82mm 1   <b>42427507</b> 55209072 0,92mm 2  <b>MLS</b> <b>ø70,5</b>
1,3 1290	4 CYL ø86,4 128 09/71-->02/76 128 08/74-->12/81 128 12/74-->10/82 128 06/75->12/79	67 PS / 49 KW 60 PS / 44 KW 73 PS / 54 KW 65 PS / 48 KW	128 A1. 128 A1. 128 A1.000 128 AC.000	<b>40307002</b> 5881127	 <b>40307005</b> 4448401 1,20mm
1,3 1301	RITMO 01/78-->09/82 RITMO 01/81-->09/82 RITMO 1978--> STRADA 01/78-->09/82 STRADA 01/81-->09/82	65 PS / 48 KW 75 PS / 55 KW 65 PS / 48 KW 65 PS / 48 KW 75 PS / 55 KW	138 A1.000 138 A3.000 128 A5.000 138 A1.000 138 A3.000	<b>40307000</b> 5881127	<b>40307006</b> 4420365 5891281 1,80mm <b>ø87,5</b>

▲ : İçerikte Bulunmamaktadır...

▲ : Not included in the set

▲ : Non inclus dans la pochette

00: Motor Takım Keçesiz ve Subap Lastiksiz

00: Gasket Set Without oil seals Without Valve Stem Seal











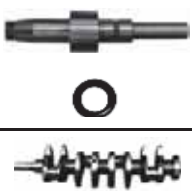



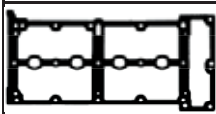
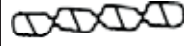

01: Motor Takım Keçesiz - Subap Lastikli

01: Gasket set With Valve Stem Seal Without Oil Seals

02: Motor Full Takım Keçeli ve Subap Lastikli

02: Gasket Full Set With oil seals and Valve Stem Seals

055

Subap Kapak Valve Cover Gasket Zylinderkopfhaube Couvre-culbut.	Karter Oil Pan Ölwanne Carter d'huile	Emme Manifold Intake Manifold Ansaug Admission	Egzoz Manifold Exhaust Manifold Auspuffkrümmer Collecteur D'echappement	Eksoz Boğaz Exhaust Pipe Auspuff Kehle	Supap Keçesi Valve Stem Seal Ventilschaft Queue de soupape	
						
 <b>42427425</b> 56 07 842		 <b>42427417</b> 58 50 674	 <b>42427421</b> 849 219		 <b>42427426x16</b> 1 547 971 6x8,8x11,7x9,5	<b>21204023</b> 40x52x7 RD <b>21204034</b> 78X100X9 RD
 <b>40304034</b> 4448677	 <b>40306013</b> 4179038	 <b>40306020x2</b> 4309031		 <b>40301018</b> 4147260	 <b>40107027x8</b> 7553637 8x10,8x14,2x10	<b>21201006</b> 30x52x7 RD <b>21201017</b> 40x56x7 RD <b>21201030</b> 64x80x8 LD
 <b>40304035</b> 7784728						

■ : Delik - Çentik

■ : Hole - Notch

■ : Trou - Entaille

NOT: Katalogdaki Orijinal Kodlar Referans Amacıyla Kullanılmıştır.Lütfen Oto Conta Kodlarını Kullanınız.  
Original codes used for reference only.Please use OTO CONTA codes for orders.



FIAT

00



01



02



03



04



Silindir Kapak  
Cylinder Head  
Zylinderkopf  
Joint de culasse



Ltr	MODEL	PS/KW	ENGINE/MOTOR		
1,3	<b>4 CYL ø86,4</b>				
1290	<b>128</b> 09/71-->02/76	67 PS / 49 KW	128 A1.	<b>40307102+</b>	
	<b>128</b> 08/74-->12/81	60 PS / 44 KW	128 A1.	<b>40307006</b>	
	<b>128</b> 12/74-->10/82	73 PS / 54 KW	128 A1.000		
	<b>128</b> 06/75-->12/79	65 PS / 48 KW	128 AC.000		
1,3	<b>RITMO</b> 01/78-->09/82	65 PS / 48 KW	138 A1.000	<b>40307100+</b>	<b>40307005</b>
1301	<b>RITMO</b> 01/81-->09/82	75 PS / 55 KW	138 A3.000	<b>40307006</b>	4448401 1,20mm
	<b>RITMO</b> 1978-->	65 PS / 48 KW	128 A5.000		<b>40307006</b>
	<b>STRADA</b> 01/78-->09/82	65 PS / 48 KW	138 A1.000		4420365 5891281 1,80mm
	<b>STRADA</b> 01/81-->09/82	75 PS / 55 KW	138 A3.000		<b>ø87,5</b>
	65 L-CL Pick-Up Todos Tipos Motor All Engine Types Tous Types de Moteur				
1,3	<b>4 CYL ø86,4</b>				
1301	<b>REGATA</b> 09/83-->07/89	65 PS / 48 KW	149 A3.000	<b>42426202</b>	
	<b>REGATA</b> 09/83-->07/89	65 PS / 48 KW	149 A7.000	5882782	<b>42426105</b>
	<b>RITMO</b> 09/83-->07/89	65 PS / 48 KW	149 A3.000		7679380 1,80mm
	<b>RITMO</b> 09/83-->07/89	65 PS / 48 KW	149 A7.000	<b>42426201</b>	<b>ø87</b>
	<b>RITMO</b> 1982-->1986	82 PS / 60 KW	138 B2.000	5882782	
	<b>UNO</b> 05/85-->08/89	65 PS / 48 KW	149 A7.000		
	<b>UNO</b> 05/85-->08/89	65 PS / 48 KW	149 A3.000		
	70 S 85 S Automático Automatic S/SX/ELX				
1,3	<b>4 CYL ø76</b>				
1297	<b>131</b> 10/74-->12/81	54 PS / 50 KW 55 PS / 40 KW 78 PS / 57 KW	131 A6.000 131 B.000	<b>40302002</b> 5880442	
	C - L - S Mirafiori			<b>40302001</b> 5880442	<b>40302005</b> 7387620 1,20mm <b>40302006</b> 7387620 1,80mm <b>ø78</b>

▲ : İçerikte Bulunmamaktadır...

▲ : Not included in the set

▲ : Non inclus dans la pochette

00: Motor Takım Keçesiz ve Subap Lastiksiz











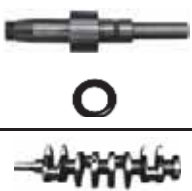













00: Gasket Set Without oil seals Without Valve Stem Seal

01: Motor Takım Keçesiz - Subap Lastikli

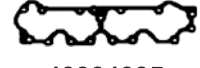
01: Gasket set With Valve Stem Seal Without Oil Seals

02: Motor Full Takım Keçeli ve Subap Lastikli

02: Gasket Full Set With oil seals and Valve Stem Seals

Subap Kapak Valve Cover Gasket Zylinderkopfhaube Couvre-culbut.	Karter Oil Pan Ölwanne Carter d'huile	Emme Manifold Intake Manifold Ansaug Admission	Egzoz Manifold Exhaust Manifold Auspuffkrümmer Collecteur D'echappement	Eksoz Boğaz Exhaust Pipe Auspuff Kehle	Supap Keçesi Valve Stem Seal Ventilschaft Queue de soupape	
						
 40304034 4448677	 40306013 4179038	 40306020x2 4309031		 40301018 4147260	 40107027x8 7553637 8x10,8x14,2x10	21201006 30x52x7 RD
 40304035 7784728						21201017 40x56x7 RD
						21201030 64x80x8 LD
 40304034 4448677	 40306013 4179038	 40306020x2 4309031		 40301018 4147260	 40107027x8 7553637 8x10,8x14,2x10	21201006 30x52x7 RD
 40304035 7784728						21201017 40x56x7 RD
						21201030 64x80x8 LD
 40301034 4130541	 40303013 4331606	 40302020x2 4336357		 40301018 4147260	 40107027x8 7553637 8x10,8x14,2x10	21201006 30x52x7 RD
						21201017 40x56x7 RD
						21201066 70x90x10 LD

■ : Delik - Çentik

■ : Hole - Notch

■ : Trou - Entaille

NOT: Katalogdaki Orijinal Kodlar Referans Amacıyla Kullanılmıştır.Lütfen Oto Conta Kodlarını Kullanınız.  
Original codes used for reference only.Please use OTO CONTA codes for orders.



FIAT

00



01



02



03



04



Silindir Kapak  
Cylinder Head  
Zylinderkopf  
Joint de culasse



Ltr	MODEL	PS/KW	ENGINE/MOTOR		
1,4 1372	<b>4 CYL ø80,5</b> TIPO 05/1989-->04/1995 TIPO 07/1987-->12/1989 TIPO 07/1987-->12/1989 TIPO 05/1989-->04/1995 UNO 09/1989-->12/1993 UNO 09/1989-->12/1993 UNO 1989-->1993 TEMPRA 10/89-->05/95 TEMPRA 1990-->1993 TEMPRA 10/92-->08/96 TEMPRA 10/92-->08/96 FIORINO 10/89-->05/95 FIORINO 10/89-->05/95 PALIO 04/96--> PALIO 04/96--> SIENA 04/96--> SIENA 04/96-->  Furgoneta i.e. S.W.	69 PS / 51 KW 71 PS / 52 KW 71 PS / 52 KW 78 PS / 57 KW 70 PS / 51 KW 72 PS / 53 KW 72 PS / 53 KW 69 PS / 51 KW 72 PS / 53 KW 69 PS / 51 KW 69 PS / 51 KW 69 PS / 51 KW 67 PS / 49 KW 67 PS / 49 KW 69 PS / 51 KW 69 PS / 51 KW 69 PS / 51 KW 69 PS / 51 KW	836 A4.000 160 A1.048 160 A1.000 160 A1.046 160 A1.046 146 C1.000 146 C1.0000 160 A1.046 159 A2.000 160 A1.046 836 A4.000 146 C5.000 146 D5.000 178 B2.000 178 B2.016 178 B2.000 178 B2.016	<b>40314002</b> 5892410  <b>40314001</b> 5892410  <b>40314003</b> 5888262	 <b>40314005</b> 7666858 1,80mm <b>ø81</b>
1,4 1368	<b>4 CYL ø72</b> IDEA 01/04-->04/06 STILO 01/04-->04/06 PANDA 10/06--> 500 500 C	90 PS / 66 KW 90 PS / 66 KW 100 PS / 74 KW	192 B2.000 843 A1.000 169 A3.000		 <b>42427905</b> 55197283 MLS <b>ø72</b>
1,4 1368	<b>4 CYL ø72</b> DOBLO 10/05--> FIORINO GRANDE PUNTO IDEA LINEA PANDA PUNTO / GRANDE PUNTO PUNTO EVO QUBO	78 PS / 57 KW 77 PS / 57 KW	350 A1.000	<b>42428002</b> Motor Full Takım Gasket Full Set  <b>42428003</b> 71740655  <b>42428004</b> 71728839	 <b>42428005</b> 55183371 MLS <b>ø72</b>

▲ : İçerikte Bulunmamaktadır...

▲ : Not included in the set

▲ : Non inclus dans la pochette

00: Motor Takım Keçesiz ve Subap Lastiksiz











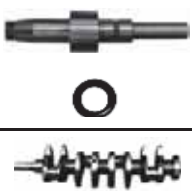





00: Gasket Set Without oil seals Without Valve Stem Seal

01: Motor Takım Keçesiz - Subap Lastikli

01: Gasket set With Valve Stem Seal Without Oil Seals

02: Motor Full Takım Keçeli ve Subap Lastikli

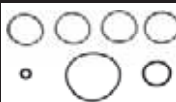
02: Gasket Full Set With oil seals and Valve Stem Seals

Subap Kapak Valve Cover Gasket Zylinderkopfhaube Couvre-culbut.	Karter Oil Pan Ölwanne Carter d'huile	Emme Manifold Intake Manifold Ansaug Admission	Egzoz Manifold Exhaust Manifold Auspuffkrümmer Collecteur D'echappement	Eksoz Boğaz Exhaust Pipe Auspuff Kehle	Supap Keçesi Valve Stem Seal Ventilschaft Queue de soupape	
						
 <b>40304034</b> 7797034	 <b>40304013</b> 7554363 76663366	 <b>40304020</b> 7772495			 <b>40107027x8</b> 7553637 8x10,8/14,2x10	<b>21201006x2</b> 30x52x7 RD
 <b>40304035</b> 7784728						<b>21201017</b> 40x56x7 RD <b>21201030</b> 64x80x8 LD
 <b>42428025</b> 71740678	 <b>42427465</b>	 <b>42428019</b> 77363787	 <b>42428020</b> 55199355		 <b>42428027x8</b> 55190344 5x7,8/11x8	<b>21208049</b> 40x55x7 <b>21208048</b> 27x37x7 RD <b>21208050</b> 74x88x8 LD

■ : Delik - Çentik

■ : Hole - Notch

■ : Trou - Entaille

NOT: Katalogdaki Orijinal Kodlar Referans Amacıyla Kullanılmıştır.Lütfen Oto Conta Kodlarını Kullanınız.  
Original codes used for reference only.Please use OTO CONTA codes for orders.



FIAT

00



Silindir Kapak  
Cylinder Head

01



Zylinderkopf

02







Joint de culasse

03



04



Ltr	MODEL	PS/KW	ENGINE/MOTOR		
1,4 1438	<b>4 CYL ø80</b> 124 01/66-->10/72 124 SPECIAL T 124 SPORT 124 COUPE	90 PS / 66 KW	124 AC.000 124 B2.000	<b>40312002</b> 5880432 <b>40312000</b> 5880432	 <b>40312005</b> 4387612 1,40mm <b>40312006</b> 4315064 1,80mm <b>ø81</b>
1,4 1367	<b>4 CYL ø78</b> 131 MIRAFIORI 1984--> L / CL			<b>43116002</b> <b>43116000</b>	 <b>43116005</b> 4434953 1,60mm <b>ø80</b>
1,4 1438	<b>4 CYL ø80</b> 124 12/68-->12/72 124 01/73-->07/75 Special	70 PS / 51 KW 75 PS / 55 KW	124 B2.000 124 B2.000	<b>43115002</b> 5880430 <b>43115000</b> 5880430	 <b>43115005</b> 4387613 1,40mm <b>43115006</b> 4137856 1,80mm <b>ø81</b>
1,5 1498	<b>4 CYL ø86,4</b> FIORINO 01/78-->10/82 RITMO 01/78-->10/82 STRADA 01/78-->10/82 75 C-CL Furgoneta Pick-Up S75	75 PS / 55 KW	138 B 18 A4	<b>40307002</b> 5881127 <b>40307000</b> 5881127	 <b>40307005</b> 4448401 1,20mm <b>40307006</b> 4420365 5891281 1,80mm <b>ø87,5</b>

▲ : İçerikte Bulunmamaktadır...

▲ : Not included in the set

▲ : Non inclus dans la pochette

00: Motor Takım Keçesiz ve Subap Lastiksiz

























00: Gasket Set Without oil seals Without Valve Stem Seal

01: Motor Takım Keçesiz - Subap Lastikli

01: Gasket set With Valve Stem Seal Without Oil Seals

02: Motor Full Takım Keçeli ve Subap Lastikli

02: Gasket Full Set With oil seals and Valve Stem Seals

Subap Kapak Valve Cover Gasket Zylinderkopfhaube Couvre-culbut.	Karter Oil Pan Ölwanne Carter d'huile	Emme Manifold Intake Manifold Ansaug Admission	Egzoz Manifold Exhaust Manifold Auspuffkrümmer Collecteur D'echappement	Eksoz Boğaz Exhaust Pipe Auspuff Kehle	Supap Keçesi Valve Stem Seal Ventilschaft Queue de soupape	
						
40308035x2 4388512	40301013 4129756	40308018 4194060	40308020 4177112 7709259	40308017 4166914	40107027x8 7553637 8x10,8/14,2x10	21201006x2 30x52x7 RD
						21201017 40x56x7 RD
40308034x2 4158646						21201066 70x90x10 LD
						21201006 30x52x7 RD
43111035 5996632	40303013 4331606	43111020 4462674		40301018 4147260		21201017 40x56x7 LD
						21201066 70x90x10 RD
						21201017 40x56x7 LD
40301034 4130541	40301013 4129756	40301020x2 4177631		40301018 4147260	40107027x8 7553637 8x10,8x14,2x10	21201066 70x90x10 RD
						21201006x2 30x52x7 RD
40304034 4448677	40306013 4179038	40306020x2 4309031		40301018 4147260	40107027x8 7553637 8x10,8x14,2x10	21201017 40x56x7 RD
						21201030 64x80x8 LD
40304035 7784728						

■ : Delik - Çentik

■ : Hole - Notch

■ : Trou - Entaille

NOT: Katalogdaki Orijinal Kodlar Referans Amacıyla Kullanılmıştır.Lütfen Oto Conta Kodlarını Kullanınız.  
Original codes used for reference only.Please use OTO CONTA codes for orders.



FIAT

00



Silindir Kapak  
Cylinder Head  
Zylinderkopf  
Joint de culasse

01



02



03



04



Ltr	MODEL	PS/KW	ENGINE/MOTOR		
1,5 1481	<b>4 CYL ø77</b> <b>1500</b> 07/62-->03/69 L <b>1500</b> 10/63-->12/70 C	102 PS / 75 KW  72 PS / 53 KW	115 000	<b>40305000</b> 900980	 <b>40305005</b> 4056553 1,40mm <b>40305006</b> 4113043 <b>ø78,5</b>
1,5	<b>4 CYL</b> <b>125</b>			<b>43112000</b>	 <b>43112005</b> 1,20mm <b>43112006</b> 1,80mm <b>ø81</b>
1,6 1585	<b>4 CYL ø84</b> <b>131 MIRAFIORI</b> 1982--> CL 1600			<b>43111002</b>  <b>43111000</b>	 <b>43111005</b> 5891304 1,70mm <b>ø85</b>
1,6 1581	<b>4 CYL ø86,4</b> <b>TEMPRA</b> 06/92-->08/96 <b>TEMPRA</b> 06/92-->08/96 <b>TEMPRA</b> 1990-->1993 <b>TIPO</b> 1989-->1995 <b>TIPO</b> 10/92-->04/95 <b>TIPO</b> 10/92-->04/95 <b>FIORINO</b> 10/93-->12/97 <b>FIORINO</b> 10/93-->12/97 <b>STRADA</b> 06/99--> <b>SCUDO</b> 02/96--> <b>PALIO</b> 1996-->1997 Furgoneta i.e. Pick-Up S.W. S/SX/ELX	75 PS / 55 KW 75 PS / 55 KW 84 PS / 62 KW 84 PS / 62 KW 75 PS / 55 KW 75 PS / 55 KW 75 PS / 55 KW 75 PS / 55 KW 75 PS / 55 KW 75 PS / 55 KW 79 PS / 58 KW 82 PS / 60 KW	159 A3.048 835 C1.000 M202PA.15.0 M202PA.15.0 159 A3.048 835 C1.000 146 C.6000 146 D.6000 1580 MPI 220 A2.000 178 B3.000	<b>40304002</b> 5890649  <b>40304001</b>  <b>40304003</b> 5888319	 <b>40304005</b> 46414567 1,80mm <b>ø87</b>

▲ : İçerikte Bulunmamaktadır...

▲ : Not included in the set

▲ : Non inclus dans la pochette

00: Motor Takım Keçesiz ve Subap Lastiksiz

00: Gasket Set Without oil seals Without Valve Stem Seal











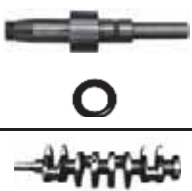

















01: Motor Takım Keçesiz - Subap Lastikli

01: Gasket set With Valve Stem Seal Without Oil Seals

02: Motor Full Takım Keçeli ve Subap Lastikli

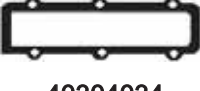
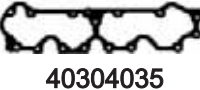
02: Gasket Full Set With oil seals and Valve Stem Seals

063

Subap Kapak Valve Cover Gasket Zylinderkopfhaube Couvre-culbut.	Karter Oil Pan Ölwanne Carter d'huile	Emme Manifold Intake Manifold Ansaug Admission	Egzoz Manifold Exhaust Manifold Auspuffkrümmer Collecteur D'echappement	Eksoz Boğaz Exhaust Pipe Auspuff Kehle	Supap Keçesi Valve Stem Seal Ventilschaft Queue de soupape	
						
 40305034 4027732	 40305013 902072	 40305016x2 4086669  40305018x2 4086677	 40305020 4072291	 40305017 4061096		
 40305034 4027732	 40305013 902072	 40305016x2 4086669  40305018x2 4086677	 40305020 4072291	 40305017 4061096		
 43111035 5996632	 40303013 4331606	 43111020 4462674		 40301018 4147260		21201006 30x52x7 RD 21201017 40x56x7 LD 21201066 70x90x10 RD
 40304034 7797034  40304035 7784728	 40304013 7554363 7663366	 40304020 7772495			 40107027x8 0956.22 8x10,8/14,2x10	21201006x2 30x52x7 RD 21201017 40x56x7 RD 21201030 64x80x8 LD

■ : Delik - Çentik

■ : Hole - Notch

■ : Trou - Entaille

NOT: Katalogdaki Orijinal Kodlar Referans Amacıyla Kullanılmıştır. Lütfen Oto Conta Kodlarını Kullanınız.  
Original codes used for reference only. Please use OTO CONTA codes for orders.



FIAT

00



01



02



03



04



Silindir Kapak  
Cylinder Head  
Zylinderkopf  
Joint de culasse



Ltr	MODEL	PS/KW	ENGINE/MOTOR		
1,6	4 CYL ø86,4				
1581	MAREA 09/99-->	103 PS / 76 KW	182 A4.000	<b>42423402</b>	
	MAREA 09/99-->	103 PS / 76 KW	185 A3.000	71713032	
	MAREA 09/99-->	103 PS / 76 KW	182 B5.098	5895664	<b>42423405</b>
	BRAVA 10/95-->10/01	90 PS / 66 KW	182 A6.000		46410960
	BRAVO 09/99-->	90 PS / 66 KW	182 A6.000		1,80mm
	MULTIPLA 04/99-->	103 PS / 76 KW	186 A4.000	<b>42423403</b>	<b>ø87</b>
	MULTIPLA 04/99-->	103 PS / 76 KW	182 A4.000	5895663	
	MULTIPLA 04/99-->	103 PS / 76 KW	186 A3.000	71713031	
	MULTIPLA 04/96-->	103 PS / 76 KW	186 A4.000		
	MULTIPLA 04/99-->	95 PS / 70 KW	186 A3.000		
	PALIO 04/96-->	100 PS / 74 KW	178 B3.000		
	PALIO 04/96-->	95 PS / 67 KW	182 A4.000		
	PALIO 04/96-->	103 PS / 76 KW	182 A6.000		
	SCUDO 1995-->	103 PS / 76 KW	182		
	SIENA 09/98-->	92 PS / 68 KW	178 D2.011		
	SIENA	103 PS / 76 KW	178 C7.098		
	16 V				
1,6	4 CYL ø84				
1585	131 MIRAFIORI 10/74-->09/81	75 PS / 55 KW	131 A1.000	<b>40303002</b>	
	242/15 10/75-->07/82	63 PS / 46 KW	124 B3.000	5880444	
	C-L-S			5880442	<b>40303005</b>
				<b>40303000</b>	5891273
				5880444	1,60mm
				5880442	<b>ø85</b>
1,6	4 CYL ø84				
1585	131 03/1973-->03/1982	98 PS / 72 KW	131 B1.000	<b>40309002</b>	
	131 01/1978-->06/1985	85 PS / 63 KW	131 C2.000	5880452	
	131 01/1978-->06/1985	97 PS / 71 KW	131 C3.000		<b>40309005</b>
	132 01/1976-->12/1982	98 PS / 72 KW	132 C.000		4387624
	132 03/1977-->12/1981	90 PS / 66 KW	132 C6.000		1,40mm
	Argento 04/1981-->12/1985	98 PS / 72 KW	132 D.000	<b>40309000</b>	
	Argento 04/1981-->12/1985	90 PS / 66 KW	132 A	5880452	<b>40309006</b>
	Ritmo 05/1981-->12/1982	105 PS / 77 KW	138 AR.000		5951675
	Berlina				1,80mm
	131 -->1982	98 PS / 72 KW	TC		<b>ø85</b>
	132 01/78-->05/82	118 PS / 86 KW	2ACT		
	REGATA 100				
	RITMO STRADA				
	131 SUPERMIRAFIORI				
	Sport				
	Super				

▲ : İçerikte Bulunmamaktadır...

▲ : Not included in the set

▲ : Non inclus dans la pochette

00: Motor Takım Keçesiz ve Subap Lastiksiz

00: Gasket Set Without oil seals Without Valve Stem Seal



















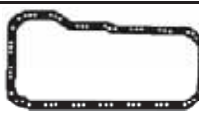





01: Motor Takım Keçesiz - Subap Lastikli

01: Gasket set With Valve Stem Seal Without Oil Seals

02: Motor Full Takım Keçeli ve Subap Lastikli

02: Gasket Full Set With oil seals and Valve Stem Seals

065

Subap Kapak Valve Cover Gasket Zylinderkopfhaube Couvre-culbut.	Karter Oil Pan Ölwanne Carter d'huile	Emme Manifold Intake Manifold Ansaug Admission	Egzoz Manifold Exhaust Manifold Auspuffkrümmer Collecteur D'echappement	Eksoz Boğaz Exhaust Pipe Auspuff Kehle	Supap Keçesi Valve Stem Seal Ventilschaft Queue de soupape	
						
 <b>42423434x2</b> 7773831 46467203	 <b>40304013</b> 7554363 7663366	 <b>42423419</b> 46410505  <b>462423415x4</b> 46402220	 <b>42423420</b> 46412116		 <b>42423427x16</b> 7581344 7x9.8x13,2x10	<b>21201006x2</b> 30x52x7 RD  <b>21201017</b> 40x56x7 RD  <b>21201030</b> 64x80x8 LD
 <b>40301034</b> 4130541	 <b>40303013</b> 4331606	 <b>40302020x2</b> 4336357		 <b>40301018</b> 4147260	 <b>40107027x8</b> 7553637 8x10,8/14,2x10	<b>21201006</b> 30x52x7 RD  <b>21201017</b> 40x56x7 LD  <b>21201066</b> 70x90x10 RD
 <b>40308035x2</b> 4388512  <b>40308034x2</b> 4158646	 <b>40303013</b> 4331606	 <b>40308018</b> 4194060	 <b>40308020</b> 4177112 7709259	 <b>40308017</b> 4166914	 <b>40107027x8</b> 7553637 8x10,8/14,2x10	<b>21201006x2</b> 30x52x7 RD  <b>21201017</b> 40x56x7 RD  <b>21201066</b> 70x90x10 LD

■ : Delik - Çentik

■ : Hole - Notch

■ : Trou - Entaille

NOT: Katalogdaki Orijinal Kodlar Referans Amacıyla Kullanılmıştır. Lütfen Oto Conta Kodlarını Kullanınız.  
Original codes used for reference only. Please use OTO CONTA codes for orders.



FIAT

00



01



02



03



04



Silindir Kapak  
Cylinder Head  
Zylinderkopf  
Joint de culasse



Ltr	MODEL	PS/KW	ENGINE/MOTOR		
1,6 1585	<b>4 CYL ø84</b> REGATA 12/87-->12/90 REGATA 01/87-->12/90 RITMO 02/88-->05/91 TIPO 02/88-->05/91	99 PS / 73 KW 99 PS / 73 KW 90 PS / 66 KW 90 PS / 66 KW	2 ACT M402AA.16.0 M402AA.16.0 149 C2.046		 <b>40330005</b> 4314165 7604264 1,80mm ø85
1,6 1592	<b>4 CYL ø80</b> 124 01/69-->12/75 124 01/69-->12/75 124 01/73-->07/75 124 11/69-->08/73 131 -->1976 132 -->1976  Special T Spider Sport Coupe	108 PS / 80 KW 104 PS / 76 KW 95 PS / 70 KW 100 PS / 74 KW 98 PS / 72 KW 98 PS / 72 KW	132 AC.000 132 AC.000 132AC 132 AC.000 828 828	<b>40308002</b> 5880448  <b>40308000</b> 5880448	 <b>40308005</b> 4263871 1,20mm  <b>40308006</b> 4263871 1,80mm ø82
1,6 1596	<b>4 CYL ø80</b> MAREA 09/00-->08/02 PALIO 02/01--> ALBEA 11/00--> STILO 10/01-->08/08	103 PS / 76 KW 103 PS / 76 KW 103 PS / 76 KW 103 PS / 76 KW	182 B6.000 182 B6.000 182 B6.000 182 B6.000		 <b>41506005</b> 55187650 46752127 1,80mm ø81
1,6 1598	<b>4 CYL ø79,5</b> DOBLO 02/10--> LINEA 06/09--> IDEA 05/08--> IDEA 05/08--> BRAVO 09/08-->  JTD 16 V	101 PS / 74 KW 105 PS / 77 KW 120 PS / 88 KW 120 PS / 88 KW 105 PS / 77 KW	263 A3.000 198 A3.000 198 A3.000 350 A2.000 198 A3.000 198 A1.000 198 A2.000	<b>42427602</b> Motor Full Takım Gasket Full Set  <b>42427603</b> 71769851  <b>42427604</b> 71749743	 <b>42427605</b> 55221093 0,82mm  <b>42427606</b> 55221094 0,92mm 1  <b>42427607</b> 55221095 1,02mm 2 <b>MLS</b> ø80,5

▲ : İçerikte Bulunmamaktadır...

▲ : Not included in the set

▲ : Non inclus dans la pochette

00: Motor Takım Keçesiz ve Subap Lastiksiz

00: Gasket Set Without oil seals Without Valve Stem Seal











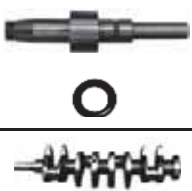





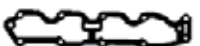

01: Motor Takım Keçesiz - Subap Lastikli

01: Gasket set With Valve Stem Seal Without Oil Seals

02: Motor Full Takım Keçeli ve Subap Lastikli

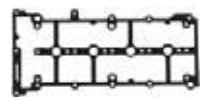
02: Gasket Full Set With oil seals and Valve Stem Seals

067

Subap Kapak Valve Cover Gasket Zylinderkopfhaube Couvre-culbut.	Karter Oil Pan Ölwanne Carter d'huile	Emme Manifold Intake Manifold Ansaug Admission	Egzoz Manifold Exhaust Manifold Auspuffkrümmer Collecteur D'echappement	Eksoz Boğaz Exhaust Pipe Auspuff Kehle	Supap Keçesi Valve Stem Seal Ventilschaft Queue de soupape	
						
 40308035x2 4388512	 40301013 4129756	 40308018 4194060	 40308020 4177112 7709259	 40308017 4166914	 40107027x8 7553637 8x10,8/14,2x10	21201006x2 30x52x7 RD
 40308034x2 4158646						21201017 40x56x7 RD
						21201066 70x90x10 LD
 42427625 55205111		 42427618 71754211	 42427621 55210879		 42427626x16 55183812 5x10x23,4x15,5	21201100 31x41x7 RD
		 42427619 46816020				21201101 30x45x7 RD

■ : Delik - Çentik

■ : Hole - Notch

■ : Trou - Entaille

NOT: Katalogdaki Orijinal Kodlar Referans Amacıyla Kullanılmıştır.Lütfen Oto Conta Kodlarını Kullanınız.  
Original codes used for reference only.Please use OTO CONTA codes for orders.



FIAT

00



01



02



03











04



Silindir Kapak  
Cylinder Head  
Zylinderkopf  
Joint de culasse



Ltr MODEL PS/KW ENGINE/MOTOR

Ltr	MODEL	PS/KW	ENGINE/MOTOR			
1,6 1598	4 CYL ø75 SCUDO JTD 16 V	01/07-->	90 PS / 66 KW	9HU	<b>41707002</b> Motor Full Takım Gasket Full Set  <b>41707003</b> Motor Üst Takım Gasket Head Set  <b>41707004</b> Motor Alt Takım Conversion Set	 <b>41707005</b> 0209.CG 1,45mm 5  <b>41707006</b> 0209.CF 1,40mm 4  <b>41707007</b> 0209.CC 1,30mm 3  <b>41707008</b> 0209.CA 1,25mm 2  <b>41707009</b> 0209.CE 1,35mm 1  MLS ø76
1,6 1608	4 CYL ø80 124 124 124 124 125 Special Sport Coupe Speyder	06/67-->10/72 06/67-->10/72 06/67-->10/72 06/67-->10/72 06/68-->12/72	90 PS / 66 KW 90 PS / 66 KW 90 PS / 66 KW 90 PS / 66 KW 100 PS / 74 KW	124 AC.000 125A 125B 125C 125C	<b>40312002</b> 5880432 <b>40312000</b> 5880432 <b>40312005</b> 4387612 1,40mm <b>40312006</b> 4315064 1,80mm ø81	

▲ : İçerikte Bulunmamaktadır...

▲ : Not included in the set

▲ : Non inclus dans la pochette

00: Motor Takım Keçesiz ve Subap Lastiksiz

00: Gasket Set Without oil seals Without Valve Stem Seal





















01: Motor Takım Keçesiz - Subap Lastikli

01: Gasket set With Valve Stem Seal Without Oil Seals

02: Motor Full Takım Keçeli ve Subap Lastikli

02: Gasket Full Set With oil seals and Valve Stem Seals

069

Subap Kapak Valve Cover Gasket Zylinderkopfhaube Couvre-culbut.	Karter Oil Pan Ölwanne Carter d'huile	Emme Manifold Intake Manifold Ansaug Admission	Egzoz Manifold Exhaust Manifold Auspuffkrümmer Collecteur D'echappement	Eksoz Boğaz Exhaust Pipe Auspuff Kehle	Supap Keçesi Valve Stem Seal Ventilschaft Queue de soupape	
						
 <b>41707025</b> 0249.C2	 <b>42427465</b>	 0348.R5 x4  0348.R4 x4 <b>41707018</b> 0348.R5+0348.R4 SET	 <b>41706021</b> 0349.J8 0349.J7 0349.N0 1 148 115		 <b>41707026x16</b> 0956.51 5,5x9,5x18,1x14	<b>21204017</b> 27x47x7 RD <b>21204018</b> 40x55x6,4 LD <b>21204019</b> 85x105x8,8 RD
 <b>40308035x2</b> 4388512  <b>40308034x2</b> 4158646	 <b>40301013</b> 4129756	 <b>40308018</b> 4194060	 <b>40308020</b> 4177112 7709259	 <b>40308017</b> 4166914	 <b>40107027x8</b> 7553637 8x10,8/14,2x10	<b>21201006x2</b> 30x52x7 RD <b>21201017</b> 40x56x7 RD <b>21201066</b> 70x90x10 LD

■ : Delik - Çentik

■ : Hole - Notch

■ : Trou - Entaille

NOT: Katalogdaki Orijinal Kodlar Referans Amacıyla Kullanılmıştır.Lütfen Oto Conta Kodlarını Kullanınız.  
Original codes used for reference only.Please use OTO CONTA codes for orders.



FIAT

00



01



02



03







04



Silindir Kapak  
Cylinder Head  
Zylinderkopf  
Joint de culasse



Ltr	MODEL	PS/KW	ENGINE/MOTOR		
1,7 1697	<b>4 CYL ø82,6</b> REGATA 05/85-->03/89 RITMO 05/85-->12/87 RITMO 05/85-->12/87 TIPO 07/86-->08/89 UNO 07/80-->08/89 DUNA 01/87-->12/91 FIORINO 05/85-->03/89	60 PS / 44 KW 60 PS / 44 KW 60 PS / 44 KW 60 PS / 44 KW 60 PS / 44 KW 60 PS / 44 KW 60 PS / 44 KW	149 B3.000 149 B3.000 138 C.000 149 B3.000 149 B3.000 149 B3.000 149 B3.000	<b>42423502</b> 5882358  <b>42423602</b> 5882358+5962713	 <b>42423505</b> 5962713 1,95mm 2 <b>M</b> <b>42423506</b> 5962712 1,80mm 1 <b>M</b> <b>42423507</b> 5962711 1,65mm ø83
1,7 1697	<b>4 CYL ø82,6</b> FIORINO 11/96-->05/01 FIORINO TD PALIO 01/94--> PALIO TD PUNTO TD SIENA STRADA TD PUNTO D 04/94-->02/00 STILO UNO  Diesel Pick-Up Turbo Diesel	63 PS / 46 KW 57 PS / 42 KW 72 PS / 53 KW 69 PS / 51 KW  57 PS / 42 KW	146 D7.000 149 B4.046 176 A3.000 176 A5.000  176 B3.000 178 C9.000	<b>42426605</b> 46431642 1,95mm 2 <b>M</b> <b>42426606</b> 46431640 1,80mm 1 <b>M</b> <b>42426607</b> 7630180 1,65mm FIBER / FIBRE ø83,5	
1,8 1756	<b>4 CYL ø84</b> TEMPRA 03/92-->08/96 TIPO 10/90-->06/93 TIPO 10/90-->06/93 TIPO 03/93-->04/95 TEMPRA 08/93-->04/96 TIPO 03/93-->04/95 TIPO 03/93-->04/95 TEMPRA 08/93-->04/96	105 PS / 77 KW 105 PS / 77 KW 105 PS / 77 KW 90 PS / 60 KW 90 PS / 60 KW 97 PS / 71 KW 90 PS / 60 KW 97 PS / 71 KW	159 A4.046 159 A4.046 159 A4.000 836 C4.000 835 C4.000 836 A5.000 836 A6.000 836 A5.000	<b>42424001</b> 5893330	 <b>42424005</b> 7660966 1,80mm ø85

▲ : İçerikte Bulunmamaktadır...

▲ : Not included in the set

▲ : Non inclus dans la pochette

00: Motor Takım Keçesiz ve Subap Lastiksiz

















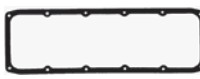

00: Gasket Set Without oil seals Without Valve Stem Seal

01: Motor Takım Keçesiz - Subap Lastikli

01: Gasket set With Valve Stem Seal Without Oil Seals

02: Motor Full Takım Keçeli ve Subap Lastikli

02: Gasket Full Set With oil seals and Valve Stem Seals

Subap Kapak Valve Cover Gasket Zylinderkopfhaube Couvre-culbut.	Karter Oil Pan Ölwanne Carter d'huile	Emme Manifold Intake Manifold Ansaug Admission	Egzoz Manifold Exhaust Manifold Auspuffkrümmer Collecteur D'echappement	Eksoz Boğaz Exhaust Pipe Auspuff Kehle	Supap Keçesi Valve Stem Seal Ventilschaft Queue de soupape	
						
 <b>43111035</b> 4394109 7702774	 <b>42423513</b> 7647596 7647596	 <b>42423520</b> 4436580 7765454			 <b>40107027x8</b> 7553637 <b>8x10,8/14,2x10</b>	<b>21201006</b> 30x52x7 RD <b>21208056</b> 30x43x8 RD <b>21201066</b> 70x90x10 LD
 <b>40330034x2</b> 7660565  <b>40331035x2</b> 7684064	 <b>42424013</b> 7646248	 <b>40330019</b> 7700197	 <b>40308020</b> 4368925		 <b>40107027x8</b> 7553637 <b>8x10,8/14,2x10</b>	

■ : Delik - Çentik

■ : Hole - Notch

■ : Trou - Entaille

NOT: Katalogdaki Orijinal Kodlar Referans Amacıyla Kullanılmıştır.Lütfen Oto Conta Kodlarını Kullanınız.  
Original codes used for reference only.Please use OTO CONTA codes for orders.



FIAT

00



01



02



03



04



Silindir Kapak  
Cylinder Head  
Zylinderkopf  
Joint de culasse



Ltr	MODEL	PS/KW	ENGINE/MOTOR		
1,8 1762	4 CYL ø83 ULYSSE 05/97-->08/02 ULYSSE 05/97-->08/02	99 PS / 73 KW 99 PS / 73 KW	LFW XU7J	41233002 0197.G4+0209.E1	 41207005 0209.E1 1,30mm 1 41207006 0209.L8 1,50mm 2 ø84,5
1,8 1796	4 CYL ø84 DUCATO 01/86-->10/88	67 PS / 49 KW	169 B 280/A14 280.A14.169B	41210001 0197.L1 0197.15	 41210005 0209.F8 ø86,7
1,8 1756	4 CYL ø84 124 01/73-->05/82 132 01/78-->05/82	114 PS / 84 KW 60 PS / 44 KW	132 A7.000 2ACT	40309002 5880452 40309000 5880452	 40309005 4387624 1,40mm 40309006 5951675 1,80mm ø85
1,9 1905	4 CYL ø83 DUCATO 04/98-->04/02 DUCATO 04/98-->04/02 SCUDO 04/98-->04/02 SCUDO 02/96-->	69 PS / 51 KW 69 PS / 51 KW 69 PS / 51 KW 69 PS / 51 KW	DJY D9B DHX(XUD9TF/L) D9B	41204002 95602514 41204003 95602513	 41204009 0209.S5 1,36 mm 1 41204008 0209.S6 1,40 mm 2 41204007 0209.S7 1,44 mm 3 41204006 0209.S8 1,48 mm 4 41204005 0209.S9 1,53 mm 5 ø 84

▲ : İçerikte Bulunmamaktadır...

▲ : Not included in the set

▲ : Non inclus dans la pochette

00: Motor Takım Keçesiz ve Subap Lastiksiz











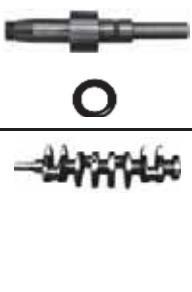







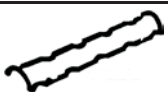









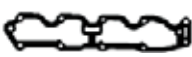

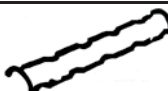

00: Gasket Set Without oil seals Without Valve Stem Seal

01: Motor Takım Keçesiz - Subap Lastikli

01: Gasket set With Valve Stem Seal Without Oil Seals

02: Motor Full Takım Keçeli ve Subap Lastikli

02: Gasket Full Set With oil seals and Valve Stem Seals

Subap Kapak Valve Cover Gasket Zylinderkopfhaube Couvre-culbut.	Karter Oil Pan Ölwanne Carter d'huile	Emme Manifold Intake Manifold Ansaug Admission	Egzoz Manifold Exhaust Manifold Auspuffkrümmer Collecteur D'echappement	Eksoz Boğaz Exhaust Pipe Auspuff Kehle	Supap Keçesi Valve Stem Seal Ventilschaft Queue de soupape	
						
 <b>41233025</b> 0249.71	 <b>41203013</b> 0304.34 93502226.	 <b>41233018x4</b> 0348.E6 + 0348F6	 <b>41233020x4</b> 1723.63		 <b>40107027x8</b> 0956.22 8x10,8/14,2x10	<b>21201062</b> 36x50x7 RD
						<b>21201019</b> 42x62x8 RD
						<b>21201040</b> 90x110x10 LD
 <b>41210525</b> 0249.14	 <b>41210013</b> 0304.44	 <b>41211016</b> 0348.33	 <b>41210020</b> 0349.03		 <b>40107027x8</b> 0956.22 8x10,8/14,2x10	
 <b>40308035x2</b> 4388512	 <b>40303013</b> 4331606	 <b>40308018</b> 4194060	 <b>40308020</b> 4177112 7709259	 <b>40308017</b> 4166914	 <b>40107027x8</b> 7553637 8x10,8/14,2x10	<b>21201006x2</b> 30x52x7 RD
 <b>40308034x2</b> 4158646						<b>21201017</b> 40x56x7 RD
						<b>21201066</b> 70x90x10 LD
 <b>41203525</b> 9350144480 0249.91	 <b>41203013</b> 96042653	 <b>41203116x2</b> 0348.99	 <b>41205019</b> 1721.01 7810024000		 <b>40107027x8</b> 7553637 8x10,8/14,2x10	<b>21201011x2</b> 35x50x8 WD
	 <b>41203014</b> 93501565	 <b>41203018x2</b> 91508659	 <b>41203120x2</b> 0349.47 93010402			<b>21201019</b> 42x62x8 RD
		 <b>41203021</b> 0348.JO				<b>21201040</b> 90x110x7 LD

■ : Delik - Çentik

■ : Hole - Notch

■ : Trou - Entaille

NOT: Katalogdaki Orijinal Kodlar Referans Amacıyla Kullanılmıştır.Lütfen Oto Conta Kodlarını Kullanınız.  
Original codes used for reference only.Please use OTO CONTA codes for orders.



FIAT

00



01



02



03















04



Silindir Kapak  
Cylinder Head  
Zylinderkopf  
Joint de culasse



Ltr	MODEL	PS/KW	ENGINE/MOTOR		
1,9 1910	4 CYL ø82 BRAVA JTD 09/96--> BRAVO JTD DOBLO JTD MAREA TD PALIO PUNTO JTD STRADA JTD BRAVO 01/01--> DOBLO DOBLO D DOBLO JTD IDEA JTD MAREA JTD MULTIPLA MULTIPLA JTD PUNTO JTD STILO STILO D STILO JTD PUNTO JTD 02/00--> DOBLO JTD 10/01-->	100 PS / 74 KW 80 PS / 59 KW  120 PS / 88 KW 80 PS / 59 KW  86 PS / 63 KW 105 PS / 77 KW 100 PS / 74 KW	182 B9.000 188 A2.000  186 A6.000 186 A8.000 186 A9.000 188 B2.000 192 A1.000 192 A3.000 192 A8.000 192 A9.000 192 B5.000 223 A7.000 937 A7.000 188 A7.000 223 B1.000 223 B2.000	42427802 71718123 71716050  42427803 71716051  42427704 71730213	 42427805 46749904 0,82mm ø83 42427806 46749905 0,92mm 1  ø83 42427807 46749906 1,02mm 2  MLS ø83
1,9 1929	4 CYL ø82,6 REGATA 04/84-->07/89 REGATA 04/84-->07/89 DUCATO 01/88-->08/90 MARENGO 1987-->1989 TALENTO 03/89-->03/94 TEMPRA 1990--> DUNA UNO Diesel Furgoneta S/SX/ELX Turbo Diesel	65 PS / 48 KW 65 PS / 48 KW 71 PS / 52 KW 70 PS / 51 KW 71 PS / 52 KW	149 A1.000 M705BA.19.0 149 B1.000 149 B1.000 149 B1.000 149 A1.000	42423502 5882358  42423602 5882358+5962713	 42423505 5962713 1,95mm 2  42423506 5962712 1,80mm 1  42423507 5962711 1,65mm ø83
1,9 1929	4 CYL ø82,6 REGATA TD 06/86-->07/89 REGATA TD 1986-->1990 RITMO TD STRADA TD	80 PS / 59 KW 80 PS / 59 KW	831 D1.000 M707AT.19.0		 42423505 5962713 1,95mm 2  42423506 5962712 1,80mm 1  42423507 5962711 1,65mm ø83

▲ : İçerikte Bulunmamaktadır...

▲ : Not included in the set

▲ : Non inclus dans la pochette

00: Motor Takım Keçesiz ve Subap Lastiksiz











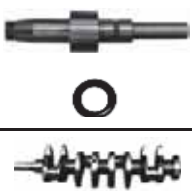





00: Gasket Set Without oil seals Without Valve Stem Seal

01: Motor Takım Keçesiz - Subap Lastikli

01: Gasket set With Valve Stem Seal Without Oil Seals

02: Motor Full Takım Keçeli ve Subap Lastikli

02: Gasket Full Set With oil seals and Valve Stem Seals

Subap Kapak Valve Cover Gasket Zylinderkopfhaube Couvre-culbut.	Karter Oil Pan Ölwanne Carter d'huile	Emme Manifold Intake Manifold Ansaug Admission	Egzoz Manifold Exhaust Manifold Auspuffkrümmer Collecteur D'echappement	Eksoz Boğaz Exhaust Pipe Auspuff Kehle	Supap Keçesi Valve Stem Seal Ventilschaft Queue de soupape	
						
 <b>42427825</b> 55197598		 <b>42427820</b> 71738458	 <b>42427821</b> 46467747		 <b>40107027x8</b> 60504110 8x10,8/14,2x10	<b>21208003</b> 30x42x7 RD
						<b>21201100</b> 31x41x7 RD
 <b>43111035</b> 4394109 7702774	 <b>42423513</b> 7647596 7647596	 <b>42423520</b> 4436580 7765454			 <b>40107027x8</b> 7553637 8x10,8/14,2x10	<b>21201006</b> 30x52x7 RD
						<b>21208056</b> 30x43x8 RD
						<b>21201066</b> 70x90x10 LD

■ : Delik - Çentik

■ : Hole - Notch

■ : Trou - Entaille

NOT: Katalogdaki Orijinal Kodlar Referans Amacıyla Kullanılmıştır.Lütfen Oto Conta Kodlarını Kullanınız.  
Original codes used for reference only.Please use OTO CONTA codes for orders.



FIAT

00



01



02



03







04



Silindir Kapak  
Cylinder Head  
Zylinderkopf  
Joint de culasse



Ltr	MODEL	PS/KW	ENGINE/MOTOR		
1,9 1868	4 CYL ø82,2 SCUDO 04/98-->	69 PS / 51 KW	WJY (DW8B) WJY (DW8)	42173002 0197.X6 	 42173005 0209.1C 1,47mm 42173006 0209.X4 1,42mm 5 ■ 42173007 0209.X3 1,38mm 4 ■ 42173008 0209.X2 1,34mm 3 ■ 42173009 0209.X1 1,30mm 2 ■ 42173010 0209.X0 1,26mm 1 ■ MLS ø84
1,9 1910	4 CYL ø82 DOBLO D PALIO PALIO D PUNTO D PUNTO DS  SIENA STRADA D 09/99-->	63 PS / 46 KW 60 PS / 45 KW	188 A3.000 223 A6.000	42427702 71715698   42427703  71715699   42427704 71730213	 42427705 46529117 0,82mm  42427706 46529118 0,92mm 1 ■  42427707 46529119 1,02mm 2 ■ MLS ø83

▲ : İçerikte Bulunmamaktadır...

▲ : Not included in the set

▲ : Non inclus dans la pochette

00: Motor Takım Keçesiz ve Subap Lastiksiz

00: Gasket Set Without oil seals Without Valve Stem Seal

















01: Motor Takım Keçesiz - Subap Lastikli

01: Gasket set With Valve Stem Seal Without Oil Seals

02: Motor Full Takım Keçeli ve Subap Lastikli

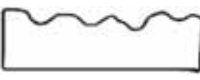
02: Gasket Full Set With oil seals and Valve Stem Seals

077

Subap Kapak Valve Cover Gasket Zylinderkopfhaube Couvre-culbut.	Karter Oil Pan Ölwanne Carter d'huile	Emme Manifold Intake Manifold Ansaug Admission	Egzoz Manifold Exhaust Manifold Auspuffkrümmer Collecteur D'echappement	Eksoz Boğaz Exhaust Pipe Auspuff Kehle	Supap Keçesi Valve Stem Seal Ventilschaft Queue de soupape	
						
 <b>42173025</b> 0249.95	 <b>41203013</b> 96042653	 <b>42173018x2</b> 0348.N2	 <b>42173021x2</b> 0349.H7		 <b>40107027x8</b> 7553637 8x10,8/14,2x10	<b>21208023</b> 35x50x8 RD <b>21201019</b> 42x62x8 RD <b>21201040</b> 90x110x10 LD
 <b>42427725</b> 46552748		 46548450x4  46548459x4 <b>42427719x8</b>	 <b>42427721</b> 46467747		 <b>40107027x8</b> 7553637 8x10,8/14,2x10	<b>21201005</b> 30x42x7 RD <b>21201100</b> 31x41x7 RD

■ : Delik - Çentik

■ : Hole - Notch

■ : Trou - Entaille

NOT: Katalogdaki Orijinal Kodlar Referans Amacıyla Kullanılmıştır.Lütfen Oto Conta Kodlarını Kullanınız.  
Original codes used for reference only.Please use OTO CONTA codes for orders.



FIAT

00



01



02



03



04



Silindir Kapak  
Cylinder Head  
Zylinderkopf  
Joint de culasse



Ltr	MODEL	PS/KW	ENGINE/MOTOR			
1,9 1929	<b>4 CYL ø82,6</b> BRAVA 10/95-->10/01 BRAVO 10/95-->10/01 DUCATO TD 06/90-->04/95 DUCATO TD 03/89-->03/94 TEMPRA TD 05/1990-->08/1996 TEMPRA TD 07/91-->08/96 TIPO TD 09/90-->04/95 DUCATO TD 04/93-->	65 PS / 48 KW 65 PS / 48 KW 90 PS / 66 KW 82 PS / 60 KW 90 PS / 66 KW 65 PS / 48 KW 90 PS / 66 KW 82 PS / 60 KW	160 A7.000 160 A7.000 280 A1.000 280 A1.000 160 A6.000 160 A7.000 160 D1.000 160 A6.000 160 A7.000 160 B.0646 160 A.0646 230 A3.000 230 A4.000			 <b>42426605</b> 46431642 1,95mm 2 <b>M</b> <b>42426606</b> 46431640 1,80mm 1 <b>M</b> <b>42426607</b> 7630180 1,65mm FIBER / FIBRE <b>ø83,5</b>
2,0 1971	<b>4 CYL ø88</b> DUCATO 1981--> TALENTO 10/81-->02/89	75 PS / 55 KW 75 PS / 55 KW	280/B25/170B 170 C 170 D XM1T 170 B	<b>41211001</b> 9400197139	 <b>41211005</b> 0209.46 1,20mm  <b>41211006</b> 0209.46 1,80mm <b>ø90</b>	
2,0 1995	<b>4 CYL ø84</b> 131 06/78-->01/82 131 06/78-->01/82 132 07/77-->06/81 ARGENTA 05/78-->07/82	115 PS / 85 KW 115 PS / 85 KW 112 PS / 82 KW 113 PS / 83 KW	131 B2.000 131 B2.000(TC) 132 C2.000 2000	<b>40309002</b> 5880452  <b>40309000</b> 5880452	 <b>40309005</b> 4387624 1,40mm  <b>40309006</b> 5951675 1,80mm <b>ø85</b>	
2,0 1995	<b>4 CYL ø84</b> TIPO 06/90-->03/92 TEMPRA 10/90-->08/96 CROMA 03/87-->09/92	109 PS / 80 KW 113 PS / 83 KW 120 PS / 8 KW	159 A5.046 159 A6.046 154 C3.000	<b>42424001</b> 5893330	 <b>42424005</b> 7660966 1,80mm <b>ø85</b>	

▲ : İçerikte Bulunmamaktadır...

▲ : Not included in the set

▲ : Non inclus dans la pochette

00: Motor Takım Keçesiz ve Subap Lastiksiz











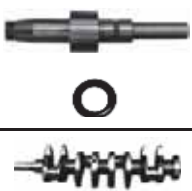







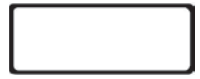







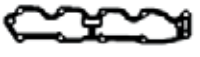

00: Gasket Set Without oil seals Without Valve Stem Seal

01: Motor Takım Keçesiz - Subap Lastikli

01: Gasket set With Valve Stem Seal Without Oil Seals

02: Motor Full Takım Keçeli ve Subap Lastikli

02: Gasket Full Set With oil seals and Valve Stem Seals

Subap Kapak Valve Cover Gasket Zylinderkopfhaube Couvre-culbut.	Karter Oil Pan Ölwanne Carter d'huile	Emme Manifold Intake Manifold Ansaug Admission	Egzoz Manifold Exhaust Manifold Auspuffkrümmer Collecteur D'echappement	Eksoz Boğaz Exhaust Pipe Auspuff Kehle	Supap Keçesi Valve Stem Seal Ventilschaft Queue de soupape	
						
 <b>41210525</b> 7910009723	 <b>41210013</b> 0322.10 0304.11	 <b>41211016</b> 7910018516  <b>41211015</b> 0348.21	 <b>41210020</b> 7910009720	 <b>41205017</b> 1710.09  <b>41212019</b> 1710.19	 <b>40107027x8</b> 7553637 8x10,8/14,2x10	
 <b>40308035x2</b> 4388512  <b>40308034x2</b> 4158646	 <b>40303013</b> 4331606	 <b>40308018</b> 4194060	 <b>40308020</b> 4177112 7709259	 <b>40308017</b> 4166914	 <b>40107027x8</b> 7553637 8x10,8/14,2x10	<b>21201006x2</b> 30x52x7 RD <b>21201017</b> 40x56x7 RD <b>21201066</b> 70x90x10 LD
 <b>40330034x2</b> 7660565  <b>40331035x2</b> 7684064	 <b>42424013</b> 7646248	 <b>40330019</b> 7700197	 <b>40308020</b> 4368925		 <b>40107027x8</b> 7553637 8x10,8/14,2x10	

■ : Delik - Çentik

■ : Hole - Notch

■ : Trou - Entaille

NOT: Katalogdaki Orijinal Kodlar Referans Amacıyla Kullanılmıştır. Lütfen Oto Conta Kodlarını Kullanınız.  
Original codes used for reference only. Please use OTO CONTA codes for orders.



FIAT

00



01



02



03



04



Silindir Kapak  
Cylinder Head  
Zylinderkopf  
Joint de culasse



Ltr	MODEL	PS/KW	ENGINE/MOTOR		
2,5 2500	4 CYL ø93 DUCATO 01/82-->12/86	75 PS / 55 KW	U25/651	41215003 0197.K1	 41215005 0209.L5 1,40mm ø95,5
2,5 2500	4 CYL ø93 DUCATO 09/86-->05/94 DUCATO TD 03/94--> DUCATO DUCATO TDI	95 PS / 70 KW 116 PS / 85 KW 109 PS / 80 KW	8140.27 8140.47 8140.47R 8140.47R.2210 8140.47.3700 8142.27S/28		 40138005 98448817 1,50mm 40138006 99461499 1,40mm ø95
2,5 2500	4 CYL ø93 DUCATO D 03/94-->04/02 CROMA D 01/82-->03/94 DUCATO D	84 PS / 62 KW 75 PS / 55 KW	8140.67 8144.67 8144.67.220		 40147005 98498291 1,80mm 40147006 98492581 1,70mm ø95,2
2,8 2799	4 CYL ø94,4 DUCATO 01/96--> DUCATO TDI	122 PS / 90 KW	8140.23 8140.43	40139000 99477116 	 40139005 99458402 1,50mm 40139006 99460983 1,40mm 40139007 99432353 1,30mm ø96

▲ : İçerikte Bulunmamaktadır...

▲ : Not included in the set

▲ : Non inclus dans la pochette

00: Motor Takım Keçesiz ve Subap Lastiksiz



















00: Gasket Set Without oil seals Without Valve Stem Seal

01: Motor Takım Keçesiz - Subap Lastikli

01: Gasket set With Valve Stem Seal Without Oil Seals

02: Motor Full Takım Keçeli ve Subap Lastikli

02: Gasket Full Set With oil seals and Valve Stem Seals

Subap Kapak Valve Cover Gasket Zylinderkopfhaube Couvre-culbut.	Karter Oil Pan Ölwanne Carter d'huile	Emme Manifold Intake Manifold Ansaug Admission	Egzoz Manifold Exhaust Manifold Auspuffkrümmer Collecteur D'echappement	Eksoz Boğaz Exhaust Pipe Auspuff Kehle	Supap Keçesi Valve Stem Seal Ventilschaft Queue de soupape	
						
 <b>41215025</b> 5893816		 <b>41215019x4</b> 5414228	 <b>41215021x4</b> 5452930	 <b>41215017</b> 95494600		
 <b>40138045</b> 500388382	 <b>40146066</b> 7301683	 <b>40146019x4</b> 98425767	 <b>40147021x4</b> 98434020			
 <b>40138047</b> 0249.C3	 <b>40138068</b> 500327440					

■ : Delik - Çentik

■ : Hole - Notch

■ : Trou - Entaille

NOT: Katalogdaki Orijinal Kodlar Referans Amacıyla Kullanılmıştır.Lütfen Oto Conta Kodlarını Kullanınız.  
Original codes used for reference only.Please use OTO CONTA codes for orders.



FIAT

00



01



02



03





04



Silindir Kapak  
Cylinder Head  
Zylinderkopf  
Joint de culasse



Ltr	MODEL	PS/KW	ENGINE/MOTOR		
2,8 2799	4 CYL ø94,4 DUCATO DUCATO JTD 11/00-->	128 PS / 94 KW 126 PS / 93 KW	8140.43S	40139100 71713696 	 <b>40139005</b> 99458402 1,50mm <b>40139006</b> 99460983 1,40mm <b>40139007</b> 99432353 1,30mm ø96
2,8 2799	4 CYL ø94,4 DUCATO DUCATO D 02/98-->04/02	87 PS / 64 KW	8140.63		 <b>40147105</b> 500306172 1,80mm <b>40147106</b> 500306171 1,70mm <b>40147107</b> 500306170 1,60mm ø96

▲ : İçerikte Bulunmamaktadır...

▲ : Not included in the set

▲ : Non inclus dans la pochette

00: Motor Takım Keçesiz ve Subap Lastiksiz













00: Gasket Set Without oil seals Without Valve Stem Seal

01: Motor Takım Keçesiz - Subap Lastikli

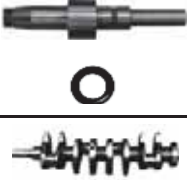
01: Gasket set With Valve Stem Seal Without Oil Seals

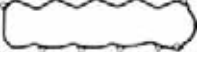
02: Motor Full Takım Keçeli ve Subap Lastikli

02: Gasket Full Set With oil seals and Valve Stem Seals

<p>Subap Kapak Valve Cover Gasket Zylinderkopfhaube Couvre-culbut.</p> 	<p>Karter Oil Pan Ölwanne Carter d'huile</p> 	<p>Emme Manifold Intake Manifold Ansaug Admission</p> 	<p>Egzoz Manifold Exhaust Manifold Auspuffkrümmer Collecteur D'echappement</p> 	<p>Eksoz Boğaz Exhaust Pipe Auspuff Kehle</p> 	<p>Supap Keçesi Valve Stem Seal Ventilschaft Queue de soupape</p> 	
 <p>40138045 500388382</p>  <p>40138047 500388381</p>	 <p>40138068 98446492</p>	 <p>40146019x4 98425767</p>	 <p>40147021x4 98434020</p>			

■ : Delik - Çentik

■ : Hole - Notch

■ : Trou - Entaille

NOT: Katalogdaki Orijinal Kodlar Referans Amacıyla Kullanılmıştır.Lütfen Oto Conta Kodlarını Kullanınız.  
Original codes used for reference only.Please use OTO CONTA codes for orders.



FORD

00



01



02



03









04



Silindir Kapak  
Cylinder Head  
Zylinderkopf  
Joint de culasse

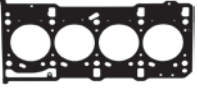

Ltr MODEL PS/KW ENGINE/MOTOR

1,3 1248	4 CYL ø69,6 KA TDCI 16V ( DOCH )	10/08-->	75 PS / 55 KW	13DDOX FD4	<b>42427402</b> Motor Full Takım Gasket Full Set   <b>42427403</b> 1 564 796  <b>42427404</b> 1 564 795 	 <b>42427505</b> 1 538 719 <b>0,72mm</b>  <b>42427506</b> 1 538 721 0,82mm 1   <b>42427507</b> 1 538 722 0,92mm 2  <b>MLS</b>  <b>ø70,5</b>
-------------	--	----------	---------------	---------------	--	--

1,3 1323	4 CYL ø71 FESTIVA ( SOCH )	1988-->1993	69 / PS / 51 KW	B3		 <b>41410605</b> B302-10-271 1,60mm  <b>41410606</b> B302-10-271 2,00mm  <b>ø74</b>
-------------	----------------------------------	-------------	-----------------	----	--	---

--	--	--	--	--	--	--

▲ : İçerikte Bulunmamaktadır...

▲ : Not included in the set

▲ : Non inclus dans la pochette

00: Motor Takım Keçesiz ve Subap Lastiksiz

00: Gasket Set Without oil seals Without Valve Stem Seal











01: Motor Takım Keçesiz - Subap Lastikli

01: Gasket set With Valve Stem Seal Without Oil Seals

02: Motor Full Takım Keçeli ve Subap Lastikli

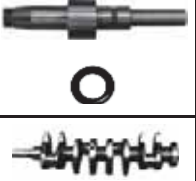
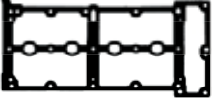
02: Gasket Full Set With oil seals and Valve Stem Seals

085

<p>Subap Kapak Valve Cover Gasket Zylinderkopfhaube Couvre-culbut.</p> 	<p>Karter Oil Pan Ölwanne Carter d'huile</p> 	<p>Emme Manifold Intake Manifold Ansaug Admission</p> 	<p>Egzoz Manifold Exhaust Manifold Auspuffkrümmer Collecteur D'echappement</p> 	<p>Eksoz Boğaz Exhaust Pipe Auspuff Kehle</p> 	<p>Supap Keçesi Valve Stem Seal Ventilschaft Queue de soupape</p> 	
 <p><b>42427425</b> 1 563 470</p>		 <p><b>42427417</b> 1 539 476</p>	 <p><b>42427421</b> 1 538 710</p>		 <p><b>42427426x16</b> 1 547 971 6x8,8x11,7x9,5</p>	<p><b>21204023</b> 40x52x7 RD</p> <p><b>21204034</b> 78X100X9 RD</p>

■ : Delik - Çentik

■ : Hole - Notch

■ : Trou - Entaille

NOT: Katalogdaki Orijinal Kodlar Referans Amacıyla Kullanılmıştır.Lütfen Oto Conta Kodlarını Kullanınız.  
Original codes used for reference only.Please use OTO CONTA codes for orders.



FORD

00



01



02



03



















04



Silindir Kapak  
Cylinder Head  
Zylinderkopf  
Joint de culasse



Ltr	MODEL	PS/KW	ENGINE/MOTOR		
1,4 1398	4 CYL ø73,7 FIESTA TDCI FUSION TDCI 11/01-->	70 PS / 51 KW 68 PS / 50 KW	F6JA F6JB F6JD DURATORQ (14DS4X)	<b>41706002</b> Motor Full Takım Gasket Full Set  <b>41706003</b> Motor Üst Takım Gasket Head Set  <b>41706004</b> Motor Alt Takım Conversion Set	 <b>41706005</b> 1 146 053 1,45mm 1  <b>41706006</b> 1 146 052 1,40mm 4  <b>41706007</b> 1 146 050 1,30mm 3  <b>41706008</b> 1 146 049 1,25mm 2  <b>41706009</b> 1 146 051 1,35mm 1  MLS ø75
1,6 1560	4 CYL ø75 C-MAX TDCI FIESTA TDCI FOCUS TDCI FUSION TDCI ( DOCH 16 V ) 10/03-->	109 PS / 80 KW 75 PS / 55 KW	G8DA G8DB G8DC G8DD G8DE G8DF HHDA HHDB HHJA HHJB HHJC HHJD HHJE HHJF MTDA UBJA DURATORQ(16DDOX)	<b>41707002</b> Motor Full Takım Gasket Full Set  <b>41707003</b> Motor Üst Takım Gasket Head Set  <b>41707004</b> Motor Alt Takım Conversion Set	 <b>41707005</b> 1 229 881 1,45mm 5  <b>41707006</b> 1 229 880 1,40mm 4  <b>41707007</b> 1 229 878 1,30mm 3  <b>41707008</b> 1 229 877 1,25mm 2  <b>41707009</b> 1 229 879 1,35mm 1  MLS ø76

▲ : İçerikte Bulunmamaktadır...

▲ : Not included in the set

▲ : Non inclus dans la pochette

00: Motor Takım Keçesiz ve Subap Lastiksiz

00: Gasket Set Without oil seals Without Valve Stem Seal

















01: Motor Takım Keçesiz - Subap Lastikli

01: Gasket set With Valve Stem Seal Without Oil Seals

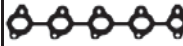
02: Motor Full Takım Keçeli ve Subap Lastikli

02: Gasket Full Set With oil seals and Valve Stem Seals

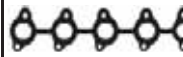
087

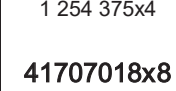
Subap Kapak Valve Cover Gasket Zylinderkopfhaube Couvre-culbut.	Karter Oil Pan Ölwanne Carter d'huile	Emme Manifold Intake Manifold Ansaug Admission	Egzoz Manifold Exhaust Manifold Auspuffkrümmer Collecteur D'echappement	Eksoz Boğaz Exhaust Pipe Auspuff Kehle	Supap Keçesi Valve Stem Seal Ventilschaft Queue de soupape	
						
						<b>2120417</b> 27x47x7 RD
<b>41706025</b> 1 148 101	<b>42427465</b>	<b>41706019x4</b> 1 148 106	<b>41706021</b> 1 148 115		<b>41706027x8</b> 5,5x9,5x22,9x17,5	<b>21204018</b> 40x55x6,4 RD
						<b>21204019</b> 85x105x8,8 LD
						<b>2120417</b> 27x47x7 RD
<b>41707025</b> 1 235 994	<b>42427465</b>	 1 254 376x4	<b>41706021</b> 1 148 115		<b>41707026x16</b> 5,5x9,5x18,1x14	<b>21204018</b> 40x55x6,4 RD
		 1 254 375x4				<b>21204019</b> 85x105x8,8 LD
		<b>41707018x8</b> SET				

■ : Delik - Çentik

■ : Hole - Notch

■ : Trou - Entaille

NOT: Katalogdaki Orijinal Kodlar Referans Amacıyla Kullanılmıştır.Lütfen Oto Conta Kodlarını Kullanınız.  
Original codes used for reference only.Please use OTO CONTA codes for orders.



FORD

00



Silindir Kapak  
Cylinder Head  
Zylinderkopf  
Joint de culasse

01



02



03



04



Ltr	MODEL	PS/KW	ENGINE/MOTOR		
1,6 1596	4 CYL ø79 C-MAX 16 V FOCUS 16 V FIESTA 16 V FUSION 16 V ( DOCH ) 10/03-->	100 PS / 74 KW	HWDA ZETEC-S(16HDEZ) FYJA		 <b>42218205</b> 1 305 949 1,20mm FIBER / FIBRE ø80
1,6 1597	4 CYL ø82,7 KA STREET 05/03-->11/08	95 PS / 70 KW	CDB CDC CDRA CDRB		 <b>41218105</b> 1 099 084 1,20mm FIBER / FIBRE ø83
1,8 1781	4 CYL ø81 BELINA DEL REY ESCORT PAMPA SCALA VERONA ROYALE VERSAILLES ( BRASIL ) 1989-->1996	85 PS / 62 KW	AP	<b>41408002</b> Motor Full Takım Gasket Full Set  <b>41408003</b> 027 198 012 L  <b>41402004</b> 037 198 011 C	 <b>41408005</b> 026 103 383K 1,75mm ø83
1,8 1796	4 CYL ø78 COURIER 1972-->1980		VB	<b>41420002</b> 8051-99-100	 <b>41420005</b> R201-10-271F 1,50mm  <b>41420006</b> R201-10-271F 2,00mm  ø80

▲ : İçerikte Bulunmamaktadır...

▲ : Not included in the set

▲ : Non inclus dans la pochette

00: Motor Takım Keçesiz ve Subap Lastiksiz

00: Gasket Set Without oil seals Without Valve Stem Seal











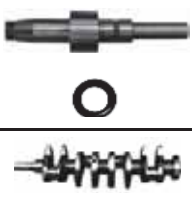







01: Motor Takım Keçesiz - Subap Lastikli

01: Gasket set With Valve Stem Seal Without Oil Seals

02: Motor Full Takım Keçeli ve Subap Lastikli

02: Gasket Full Set With oil seals and Valve Stem Seals

089

Subap Kapak Valve Cover Gasket Zylinderkopfhaube Couvre-culbut.	Karter Oil Pan Ölwanne Carter d'huile	Emme Manifold Intake Manifold Ansaug Admission	Egzoz Manifold Exhaust Manifold Auspuffkrümmer Collecteur D'echappement	Eksoz Boğaz Exhaust Pipe Auspuff Kehle	Supap Keçesi Valve Stem Seal Ventilschaft Queue de soupape	
						
 <b>41401034</b> 026 198 025 A	 <b>41401013</b> 028 103 609 A	 <b>41401019</b> 026129717D	 <b>41401021x4</b> 026 129 589 A	 <b>41401017</b> 841 253 115 B	 <b>40107027x8</b> 8x10,8x14,2x10	<b>21201075x3</b> 32x47x10 WD  <b>21204504</b> 85X105X12 LD
 <b>41420034</b> 022110235A	 <b>41420013</b> 0221-10-431	 <b>41420019</b> 038113111A	 <b>41420020</b> 0221-13-462	 <b>41420017</b> 802B-13-483		<b>21201026</b> 48x70x12 RD  <b>21201205</b> 80x105x13 LD

■ : Delik - Çentik

■ : Hole - Notch

■ : Trou - Entaille

NOT: Katalogdaki Orijinal Kodlar Referans Amacıyla Kullanılmıştır.Lütfen Oto Conta Kodlarını Kullanınız.  
Original codes used for reference only.Please use OTO CONTA codes for orders.



FORD

00



01



02



03









04



Silindir Kapak  
Cylinder Head  
Zylinderkopf  
Joint de culasse



Ltr MODEL PS/KW ENGINE/MOTOR

1,9 1896	4 CYL ø79,5 GALAXY TDI	03/95-->05/06	90 PS / 66 KW	1Z AFN AHU	<b>41405202</b> Motor Full Takım Gasket Full Set   <b>41405203</b> 1 009 167  <b>41405104</b> 1 004 926 	 <b>41405207</b> 1 079 766 1 005 254 1,45mm 1 ■ <b>41405206</b> 1 079 767 1 005 258 1,53mm 2 ■ <b>41405205</b> 1 079 768 1 005 261 1,61mm 3 ■ <b>MLS</b> ø81
2,0 1984	4 CYL ø82,5 VERSAILLES ROYALE ESCORT VERONA ( BRASIL )	1992-->1995		AP	<b>41408102</b>	 <b>41408105</b> 048 103 383B 1,75mm ø83,5
2,0 1999	4 CYL ø87,5 C-MAX 16 V FIESTA 16 V FOCUS 16 V GALAXY 16 V MONDEO 16 V S-MAX 16 V FUSION 16 V	03/04-->	150 PS / 110 KW 145 PS / 107 KW	AOBA AOBC AODA AODB AODE AOWA AOWB N4JB SYDA TBBA TBBB TBWA TBWB CJBA DURATEC-HE(20HDEA		 <b>41420405</b> 1 229 872 1,20mm FIBER / FIBRE ø89

▲ : İçerikte Bulunmamaktadır...

▲ : Not included in the set

▲ : Non inclus dans la pochette

00: Motor Takım Keçesiz ve Subap Lastiksiz











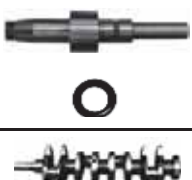







00: Gasket Set Without oil seals Without Valve Stem Seal

01: Motor Takım Keçesiz - Subap Lastikli

01: Gasket set With Valve Stem Seal Without Oil Seals

02: Motor Full Takım Keçeli ve Subap Lastikli

02: Gasket Full Set With oil seals and Valve Stem Seals

Subap Kapak Valve Cover Gasket Zylinderkopfhaube Couvre-culbut.	Karter Oil Pan Ölwanne Carter d'huile	Emme Manifold Intake Manifold Ansaug Admission	Egzoz Manifold Exhaust Manifold Auspuffkrümmer Collecteur D'echappement	Eksoz Boğaz Exhaust Pipe Auspuff Kehle	Supap Keçesi Valve Stem Seal Ventilschaft Queue de soupape	
						
 <b>41405225</b> 028 103 483 C 028 103 483 G	 <b>41401014</b> 1 033 121	 <b>41405121</b> 1 006 217	 <b>41401021x4</b> 026 129 589 A 028 129 589 B		 <b>40107027x8</b> 1 669 785 8x10,8/14,2x10	<b>21201075x3</b> 32x47x10 WD  <b>21204504</b> 85x105x12 LD
 <b>41401034</b> 026 198 025 A	 <b>41401013</b> 028 103 609 A	 <b>41401019</b> 026 129 717 D	 <b>41401021x4</b> 026 129 589 A 056 129 589 B	 <b>41408017</b> 841 253 115 B	 <b>40107027x8</b> 026 109 675 8x10,8/14,2x10	<b>21201075x3</b> 32x47x10 W  <b>21204504</b> 85x105x12 LD

■ : Delik - Çentik

■ : Hole - Notch

■ : Trou - Entaille

NOT: Katalogdaki Orijinal Kodlar Referans Amacıyla Kullanılmıştır.Lütfen Oto Conta Kodlarını Kullanınız.  
Original codes used for reference only.Please use OTO CONTA codes for orders.



FORD

00



Silindir Kapak  
Cylinder Head  
Zylinderkopf  
Joint de culasse

01



02



03



04



Ltr	MODEL	PS/KW	ENGINE/MOTOR		
2,1 2112	4 CYL ø90 GRANADA DIESEL 08/77-->08/82	63PS / 47KW	GD21	41212002 0198.40	 <b>41212005</b> 1 576 302 1,60mm <b>41212006</b> 1 576 302 1,80mm <b>ø94</b>
2,2 2184	4 CYL ø86 PROBE 12 V PROBE TURBO 12 V RANGER 12 V 08/88-->07/93 03/99-->07/03	112 PS / 82 KW 147 PS / 108 KW	F2		 <b>41420305</b> F202-10-271 1,40mm <b>41420306</b> F202-10-271 1,80mm <b>ø87,5</b>
2,2 2209	4 CYL ø92 RANGER 2WD	63 PS / 46 KW	S2		 <b>41480005</b> 0527-10-271A <b>Ø 97</b>
2,3 2261	4 CYL ø87,5 MAVERICK 16V (DOCH ) TRANSIT 03/04--> 04/06-->	150 PS / 110 KW 145 PS / 107 KW	GZ GZFA GZFC		 <b>41420405</b> 1 229 872 1,20mm FIBER / FIBRE <b>ø89</b>

▲ : İçerikte Bulunmamaktadır...

▲ : Not included in the set

▲ : Non inclus dans la pochette

00: Motor Takım Keçesiz ve Subap Lastiksiz

00: Gasket Set Without oil seals Without Valve Stem Seal

















01: Motor Takım Keçesiz - Subap Lastikli

01: Gasket set With Valve Stem Seal Without Oil Seals

02: Motor Full Takım Keçeli ve Subap Lastikli

02: Gasket Full Set With oil seals and Valve Stem Seals

093

Subap Kapak Valve Cover Gasket Zylinderkopfhaube Couvre-culbut.	Karter Oil Pan Ölwanne Carter d'huile	Emme Manifold Intake Manifold Ansaug Admission	Egzoz Manifold Exhaust Manifold Auspuffkrümmer Collecteur D'echappement	Eksoz Boğaz Exhaust Pipe Auspuff Kehle	Supap Keçesi Valve Stem Seal Ventilschaft Queue de soupape	
						
 <b>41212525</b> 1 651 701	 <b>41212014</b> 0313.19  <b>41212015</b> 0304.12	 <b>41212016x3</b> 0348.11	 <b>41212020x2</b> 1 576 449	 <b>41205018</b> 1710.07  <b>41212018</b> 1710.15  <b>41212019</b> 1710.19		<b>21201020</b> 42x60x10 RD

■ : Delik - Çentik

■ : Hole - Notch

■ : Trou - Entaille

NOT: Katalogdaki Orijinal Kodlar Referans Amacıyla Kullanılmıştır.Lütfen Oto Conta Kodlarını Kullanınız.  
Original codes used for reference only.Please use OTO CONTA codes for orders.



FORD

00



01



02



03















04



Silindir Kapak  
Cylinder Head  
Zylinderkopf  
Joint de culasse



Ltr MODEL PS/KW ENGINE/MOTOR

Ltr	MODEL	PS/KW	ENGINE/MOTOR		
2,3 2304	4 CYL ø94 SIERRA D 08/82-->02/93	67 PS / 49 KW	YTR YTT(XDP2)	41218000 0198.94 	 41218005 6 812 074 1,73mm 4  41218006 6 812 073 1,63mm 3  41218007 6 812 072 1,53mm 2  ø96
2,3 2346	4 CYL ø91 RANGER 2WD C RANGER 4WD D BRONCO II TD 1985-->1987	82 PS / 67 KW	4D55T	41450001 MD050092  41450002 MD050092	 41450005 MD050545 1,80mm ø92,5
2,5 2498	4 CYL ø94 GRANADA SCORPIO SCORPIO TD GRANADA TD 08/82-->07/93	92 PS / 68 KW 69 PS / 51 KW	SFA SFB STP STR XD3	41218000 0198.94 	 41218005 6 812 074 1,73mm 4  41218006 6 812 073 1,63mm 3  41218007 6 812 072 1,53mm 2  ø96

▲ : İçerikte Bulunmamaktadır...

▲ : Not included in the set

▲ : Non inclus dans la pochette

00: Motor Takım Keçesiz ve Subap Lastiksiz

00: Gasket Set Without oil seals Without Valve Stem Seal











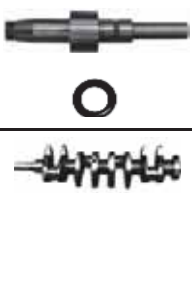













01: Motor Takım Keçesiz - Subap Lastikli

01: Gasket set With Valve Stem Seal Without Oil Seals

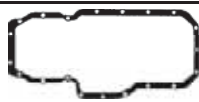
02: Motor Full Takım Keçeli ve Subap Lastikli

02: Gasket Full Set With oil seals and Valve Stem Seals

095

Subap Kapak Valve Cover Gasket Zylinderkopfhaube Couvre-culbut.	Karter Oil Pan Ölwanne Carter d'huile	Emme Manifold Intake Manifold Ansaug Admission	Egzoz Manifold Exhaust Manifold Auspuffkrümmer Collecteur D'echappement	Eksoz Boğaz Exhaust Pipe Auspuff Kehle	Supap Keçesi Valve Stem Seal Ventilschaft Queue de soupape	
						
 <b>41212525</b> 1 651 701	 <b>41212014</b> 6 894 122  <b>41212015</b> 0304.12	 <b>41212016x3</b> 0348.11	 <b>41212020x2</b> 0349.10	 <b>41212018</b> 1710.15  <b>41212019</b> 1710.19		
 <b>41450025</b> MD050312	 <b>41450013</b> MD149392	 <b>41450021</b> MD050482			 <b>41450026x8</b> 8x13x9x13	<b>21201013</b> 35x50x8 RD <b>21201023</b> 44x60x7 RD <b>21201035</b> 80x96x9 LD <b>21201004</b> 25x35x6 <b>21201001</b> 17x28x7
 <b>41212525</b> 1 651 701	 <b>41212014</b> 6 894 122  <b>41212015</b> 0304.12	 <b>41212016x3</b> 0348.11	 <b>41212020x2</b> 0349.10	 <b>41212018</b> 1710.15  <b>41212019</b> 1710.19		

■ : Delik - Çentik

■ : Hole - Notch

■ : Trou - Entaille

NOT: Katalogdaki Orijinal Kodlar Referans Amacıyla Kullanılmıştır.Lütfen Oto Conta Kodlarını Kullanınız.  
Original codes used for reference only.Please use OTO CONTA codes for orders.



HONDA

00



Silindir Kapak

Cylinder Head

01



Zylinderkopf

02



Joint de culasse

03



04



Ltr	MODEL	PS/KW	ENGINE/MOTOR	
1,2 1238 1,3 1335	4 CYL ø72 CIVIC CIVIC	03/77-->12/80 09/79-->09/83	54 PS / 40 KW 60 PS / 44 KW	EB1 EB2 EB3 EN1 EN4
1,6 1602	4 CYL ø77 ACCORD QUINTET PRELUDE	01/78-->09/93	80 PS / 59 KW	EG EL EL14



41430005

12251-634-010

1,40mm

ø74



41440005

12251-PC1-000

1,40mm

ø78

▲ : İçerikte Bulunmamaktadır...

▲ : Not included in the set

▲ : Non inclus dans la pochette

00: Motor Takım Keçesiz ve Subap Lastiksiz

00: Gasket Set Without oil seals Without Valve Stem Seal







01: Motor Takım Keçesiz - Subap Lastikli

01: Gasket set With Valve Stem Seal Without Oil Seals

02: Motor Full Takım Keçeli ve Subap Lastikli

02: Gasket Full Set With oil seals and Valve Stem Seals

097

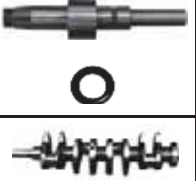
<p>Subap Kapak Valve Cover Gasket Zylinderkopfhaube Couvre-culbut.</p> 	<p>Karter Oil Pan Ölwanne Carter d'huile</p> 	<p>Emme Manifold Intake Manifold Ansaug Admission</p> 	<p>Egzoz Manifold Exhaust Manifold Auspuffkrümmer Collecteur D'echappement</p> 	<p>Eksoz Boğaz Exhaust Pipe Auspuff Kehle</p> 	<p>Supap Keçesi Valve Stem Seal Ventilschaft Queue de soupape</p> 	

■ : Delik - Çentik

■ : Hole - Notch

■ : Trou - Entaille

NOT: Katalogdaki Orijinal Kodlar Referans Amacıyla Kullanılmıştır.Lütfen Oto Conta Kodlarını Kullanınız.  
Original codes used for reference only.Please use OTO CONTA codes for orders.



HYUNDAI

00



Silindir Kapak  
Cylinder Head  
Zylinderkopf  
Joint de culasse

01



02



03



04



Ltr	MODEL	PS/KW	ENGINE/MOTOR		
1,1 1086	4 CYL ø67 ATOS PRIME 12V ( SOCH ) 06/05-->01/07	63 PS / 46 KW	G4HG		 <b>41410405</b> 22311-02760 1,20mm FIBER / FIBRE ø68
1,3 1298	4 CYL ø71 PONY ( SOCH ) 10/89-->01/95	58 PS / 43 KW	G4M G13B G4DG		 <b>41507005</b> MD066163 1,40mm ø72,5
1,3 1341	4 CYL ø71,5 ACCENT 12V GETZ 12V ( SOCH ) 10/94-->01/000 09/02-->09/05	82 PS / 60 KW 84 PS / 62 KW	G4EA	<b>61500002</b> Motor Full Takım Gasket Full Set	 <b>41500005</b> 22311-22360 1,40mm FIBER / FIBRE ø73mm
1,4 1399	4 CYL ø75,5 GETZ 16V ACCENT 16V VERNA 16V ( DOCH ) 08/05-->11/10	97 PS / 71 KW	G4EE		 <b>41410505</b> 22311-26603 1,20mm FIBER / FIBRE ø77
1,4 1396	4 CYL ø77 i30 16V ix20 16V 10/07-->11/11 09/08-->	105 PS / 77 KW 109 PS / 80 KW 90 PS / 66 KW 101 PS / 74 KW	G4FA		 <b>41510106</b> 22311-2B003 1,20mm FIBER / FIBRE ø78,5

▲ : İçerikte Bulunmamaktadır...

▲ : Not included in the set

▲ : Non inclus dans la pochette

00: Motor Takım Keçesiz ve Subap Lastiksiz

00: Gasket Set Without oil seals Without Valve Stem Seal















01: Motor Takım Keçesiz - Subap Lastikli

01: Gasket set With Valve Stem Seal Without Oil Seals

02: Motor Full Takım Keçeli ve Subap Lastikli

02: Gasket Full Set With oil seals and Valve Stem Seals

099

Subap Kapak Valve Cover Gasket Zylinderkopfhaube Couvre-culbut.	Karter Oil Pan Ölwanne Carter d'huile	Emme Manifold Intake Manifold Ansaug Admission	Egzoz Manifold Exhaust Manifold Auspuffkrümmer Collecteur D'echappement	Eksoz Boğaz Exhaust Pipe Auspuff Kehle	Supap Keçesi Valve Stem Seal Ventilschaft Queue de soupape	
						
 <b>41490025</b> 22441-22012	 <b>41490013</b> 21451-21010	 <b>41490018</b> 28411-26600  <b>41490016</b>	 <b>41490021</b> 28521-22020	 <b>41490017</b> 22224-22000	 <b>41490027x12</b> 22224-22000 6x11x6x10,2	<b>21201011</b> 35x50x8 RD <b>21201032</b> 72x96x9 LD

■ : Delik - Çentik

■ : Hole - Notch

■ : Trou - Entaille

NOT: Katalogdaki Orijinal Kodlar Referans Amacıyla Kullanılmıştır.Lütfen Oto Conta Kodlarını Kullanınız.  
Original codes used for reference only.Please use OTO CONTA codes for orders.



HYUNDAI

00



Silindir Kapak  
Cylinder Head

01



Zylinderkopf

02



Joint de culasse

03



04



Ltr	MODEL	PS/KW	ENGINE/MOTOR		
1,5 1468	4 CYL ø75,5 EXCELL PONY LANTRA S-COUPE ( SOCH ) 10/85-->05/96	86 PS / 63 KW 72 PS / 53 KW	G15B G4DJ G4J		 <b>41500305</b> MD016163 1,40mm <b>41500306</b> MD016163 2,00mm ø76,5
1,5 1495	4 CYL ø75,5 ACCENT LANTRA S COUPE ( SOCH ) 10/94-->01/00	88 PS / 65 KW	G4EK	<b>41490002</b> 20910-22A00	 <b>41490005</b> 22311-22130 1,40mm FIBER / FIBRE ø77
1,6 1591	4 CYL ø77 i30 i20 ix20 10/07-->11/11 09/08--> 11/10-->	116 PS / 85 KW 126 PS / 93 KW 125 PS / 92 KW	G4FC		 <b>41510106</b> 22311-2B003 1,20mm FIBER / FIBRE ø78,5

▲ : İçerikte Bulunmamaktadır...

▲ : Not included in the set

▲ : Non inclus dans la pochette

00: Motor Takım Keçesiz ve Subap Lastiksiz











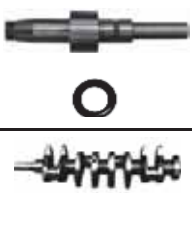



00: Gasket Set Without oil seals Without Valve Stem Seal

01: Motor Takım Keçesiz - Subap Lastikli

01: Gasket set With Valve Stem Seal Without Oil Seals

02: Motor Full Takım Keçeli ve Subap Lastikli

02: Gasket Full Set With oil seals and Valve Stem Seals

Subap Kapak Valve Cover Gasket Zylinderkopfhaube Couvre-culbut.	Karter Oil Pan Ölwanne Carter d'huile	Emme Manifold Intake Manifold Ansaug Admission	Egzoz Manifold Exhaust Manifold Auspuffkrümmer Collecteur D'echappement	Eksoz Boğaz Exhaust Pipe Auspuff Kehle	Supap Keçesi Valve Stem Seal Ventilschaft Queue de soupape	
						
						<b>21201011</b> 35x50x8 RD
<b>41490025</b> 22441-22012	<b>41490013</b> 21451-21010	<b>41490018</b> 28411-26600	<b>41490021</b> 28521-22020	<b>41490017</b> 22224-22000	<b>41490027x12</b> 22224-22000 6x11x6x10,2	<b>21201032</b> 72x96x9 LD
						
		<b>41490016</b>				

■ : Delik - Çentik

■ : Hole - Notch

■ : Trou - Entaille

NOT: Katalogdaki Orijinal Kodlar Referans Amacıyla Kullanılmıştır.Lütfen Oto Conta Kodlarını Kullanınız.  
Original codes used for reference only.Please use OTO CONTA codes for orders.



HYUNDAI

00



01



02



03



04



Silindir Kapak  
Cylinder Head  
Zylinderkopf  
Joint de culasse



Ltr	MODEL	PS/KW	ENGINE/MOTOR		
1,8 1795	4 CYL ø82 ELANTRA 16V LAVITA 16V MATRIX 16V	122 PS / 90 KW	G4GB G4GB2		 <b>41418005</b> 22311-23700 1,20mm FIBER / FIBRE ø84
1,9 1,905	4 CYL ø83 LANTRA ( SOCH ) 03/98-->10/00	68 PS / 50 KW	XUD9	<b>41204002</b> 0197.H5  <b>41204003</b> 0197.H4 	 <b>41204009</b> 0209.S5 1,36 mm 1 <b>41204008</b> 0209.S6 1,40 mm 2 <b>41204007</b> 0209.S7 1,44 mm 3 <b>41204006</b> 0209.S8 1,48 mm 4 <b>41204005</b> 0209.S9 1,53 mm 5 ø 84
2,00 1975	4 CYL ø82 ELANTRA 16V TUSCON 16V i 30 16V COUPE 16V ( DOCH ) 06/00-->07/06 08/04-->03/10	141 PS / 104 KW 143 PS / 105 KW	G4GC		 <b>41418005</b> 22311-23700 1,20mm FIBER / FIBRE ø84
2,0 1997	4 CYL ø85 SONATA SANTAMO 09/88-->08/91	101 PS / 74 KW	G4P		 <b>41500905</b> MD040533 1,40mm <b>41500906</b> MD040533 2,00mm ø86

▲ : İçerikte Bulunmamaktadır...

▲ : Not included in the set

▲ : Non inclus dans la pochette

00: Motor Takım Keçesiz ve Subap Lastiksiz











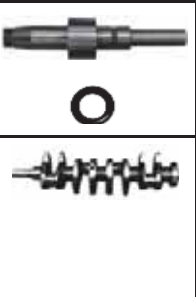







00: Gasket Set Without oil seals Without Valve Stem Seal

01: Motor Takım Keçesiz - Subap Lastikli

01: Gasket set With Valve Stem Seal Without Oil Seals

02: Motor Full Takım Keçeli ve Subap Lastikli

02: Gasket Full Set With oil seals and Valve Stem Seals

Subap Kapak Valve Cover Gasket Zylinderkopfhaube Couverculbut.	Karter Oil Pan Ölwanne Carter d'huile	Emme Manifold Intake Manifold Ansaug Admission	Egzoz Manifold Exhaust Manifold Auspuffkrümmer Collecteur D'echappement	Eksoz Boğaz Exhaust Pipe Auspuff Kehle	Supap Keçesi Valve Stem Seal Ventilschaft Queue de soupape	
						
 <p>41203525 0249.46 0249.91</p>	 <p>41203013 0304.34</p>  <p>41203014 93501565</p>	 <p>41203116x2 9456044080</p>  <p>41203018x2 91508659</p>  <p>41203021 0348.JO</p>	 <p>41205019 1721.01 7810024000</p>  <p>41203120x2 0349.47 93010402</p>	 <p>40107027x8 0956.22 8x10,8/14,2x10</p>	 <p>21201011x2 35x50x8 WD</p> <p>21201019 42x62x8 RD</p> <p>21201040 90x110x7 LD</p>	

■ : Delik - Çentik

■ : Hole - Notch

■ : Trou - Entaille

NOT: Katalogdaki Orijinal Kodlar Referans Amacıyla Kullanılmıştır.Lütfen Oto Conta Kodlarını Kullanınız.  
Original codes used for reference only.Please use OTO CONTA codes for orders.



HYUNDAI

00



01



02



03



04



Silindir Kapak  
Cylinder Head  
Zylinderkopf  
Joint de culasse



Ltr	MODEL	PS/KW	ENGINE/MOTOR		
2,0 1997	4 CYL ø85 SONATA 16V 06/98--> TRAJET 16V SANTA FE 16V (DOCH)	136 PS / 100 KW 131 PS / 96 KW	G4BP G4JP-EG G4JP-G G43P		 <b>41510005</b> 22311-38100 1,20mm FIBER / FIBRE ø86
2,4 2359	4 CYL ø88 SONATA NF 16V 01/05--> (DOCH)	162 PS / 119 KW	G4KC		 <b>41419005</b> 22311-25211 1,20mm FIBER / FIBRE <b>41419006</b> 22311-25211 1,80mm FIBER / FIBRE ø90
2,4 2351	4 CYL ø86,5 SONATA EF 16V 99-->01 SANTA FE 16V (DOCH)	135 PS / 99 KW 146 PS / 100 KW	G4JS2		 <b>41510205</b> 22311-38200 1,20mm FIBER/FIBRE
2,5 2476	4 CYL ø91 H100 D 12/94-->03/00 H100 (AU) 10/97-->04/04 H1 H100TD H1 TD H1 TCI GALLOPER TD LIBERO LEBERO TCI	78PS / 57 KW 80 PS / 59 KW 99 PS / 73 KW 101 PS / 74 KW	D4BA/X D4BF D4BH 4D56TCI D4BF/D4BH 4D56	<b>41450001</b> MD050092  <b>41450002</b> MD050092	 <b>41450005</b> MD050545 1,80mm <b>ø92,5</b>
2,5 2497	4 CYL ø91 H-1 CRDI 08/03-->04/04	140 PS / 103 KW	D4CB		 <b>41415505</b> 22311-4A000 1,40mm FIBER / FIBRE ø92,5

▲ : İçerikte Bulunmamaktadır...

▲ : Not included in the set

▲ : Non inclus dans la pochette

00: Motor Takım Keçesiz ve Subap Lastiksiz











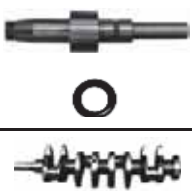

00: Gasket Set Without oil seals Without Valve Stem Seal

01: Motor Takım Keçesiz - Subap Lastikli

01: Gasket set With Valve Stem Seal Without Oil Seals

02: Motor Full Takım Keçeli ve Subap Lastikli

02: Gasket Full Set With oil seals and Valve Stem Seals

Subap Kapak Valve Cover Gasket Zylinderkopfhaube Couvre-culbut.	Karter Oil Pan Ölwanne Carter d'huile	Emme Manifold Intake Manifold Ansaug Admission	Egzoz Manifold Exhaust Manifold Auspuffkrümmer Collecteur D'echappement	Eksoz Boğaz Exhaust Pipe Auspuff Kehle	Supap Keçesi Valve Stem Seal Ventilschaft Queue de soupape	
						
						<b>21201013</b> 35x50x8 RD
<b>41450025</b> MD050312	<b>41450013</b> MD149392	<b>41450021</b> MD050482			<b>41450026x8</b> 8x13x9x13	<b>21201023</b> 44x60x7 RD <b>21201035</b> 80x96x9 LD <b>21201004</b> 25x35x6 <b>21201001</b> 17x28x7

■ : Delik - Çentik

■ : Hole - Notch

■ : Trou - Entaille

NOT: Katalogdaki Orijinal Kodlar Referans Amacıyla Kullanılmıştır.Lütfen Oto Conta Kodlarını Kullanınız.  
Original codes used for reference only.Please use OTO CONTA codes for orders.



HYUNDAI

00



01



02



03



04



Silindir Kapak  
Cylinder Head  
Zylinderkopf  
Joint de culasse



Ltr	MODEL	PS/KW	ENGINE/MOTOR		
2,5 2476	4 CYL ø91 GALLOPER Tci 07/93--> GALLOPER TD GRACE D GRACE TD H-1 TD H100 D H100 TD PORTER Tci PORTER TD STAREX Tci STAREX TD TERRACAN D TERRACAN TD	105 PS / 77 KW 75 PS / 55 KW	D4BA D4BF D4BH D4BX	41470002 1000A901 	 41470005 MD302893 1,60mm 5 41470006 22311-42525 1,55mm 4 41470007 22311-42855 1,50mm 3 41470008 22311-42515 1,45mm 2  ø92,5
2,6 2607	4 CYL ø91 H100 D 04/96-->09/99 H100 (AU ) H1 H100 (AU-M)	85 PS / 60 KW	D4BB	41450001 MD050092   41450002 MD050092	 41450005 MD050545 1,80mm  ø92,5
3,3 3342	3 CYL ø92 SONATA V 01/08-->	250 PS / 184 KW	G6DB		41510305  22311-3C140 1,50mm FIBER / FIBRE  22311-3C130 1,50mm FIBER / FIBRE ø93,5

▲ : İçerikte Bulunmamaktadır...

▲ : Not included in the set

▲ : Non inclus dans la pochette

00: Motor Takım Keçesiz ve Subap Lastiksiz











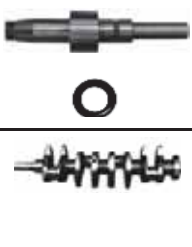





00: Gasket Set Without oil seals Without Valve Stem Seal

01: Motor Takım Keçesiz - Subap Lastikli

01: Gasket set With Valve Stem Seal Without Oil Seals

02: Motor Full Takım Keçeli ve Subap Lastikli

02: Gasket Full Set With oil seals and Valve Stem Seals

Subap Kapak Valve Cover Gasket Zylinderkopfhaube Couvre-culbut.	Karter Oil Pan Ölwanne Carter d'huile	Emme Manifold Intake Manifold Ansaug Admission	Egzoz Manifold Exhaust Manifold Auspuffkrümmer Collecteur D'echappement	Eksoz Boğaz Exhaust Pipe Auspuff Kehle	Supap Keçesi Valve Stem Seal Ventilschaft Queue de soupape	
						
 <b>41450025</b> MD050312	 <b>41450013</b> MD149392	 <b>41470021</b> 28520-42070			 <b>41450026x8</b> 8x13x9x13	<b>21201013</b> 35x50x8 RD <b>21201023</b> 44x60x7 RD <b>21201035</b> 80x96x9 LD <b>21201004</b> 25x35x6 <b>21201001</b> 17x28x7
 <b>41450025</b> MD050312	 <b>41450013</b> MD149392	 <b>41450021</b> MD050482			 <b>41450026x8</b> 8x13x9x13	<b>21201013</b> 35x50x8 RD <b>21201023</b> 44x60x7 RD <b>21201035</b> 80x96x9 LD <b>21201004</b> 25x35x6 <b>21201001</b> 17x28x7

■ : Delik - Çentik

■ : Hole - Notch

■ : Trou - Entaille

NOT: Katalogdaki Orijinal Kodlar Referans Amacıyla Kullanılmıştır.Lütfen Oto Conta Kodlarını Kullanınız.  
Original codes used for reference only.Please use OTO CONTA codes for orders.



HYUNDAI

00



Silindir Kapak

Cylinder Head

01



Zylinderkopf

02



Joint de culasse



03





04



Ltr MODEL PS/KW ENGINE/MOTOR

3,5 3497	6 CYL ø93 TERRACAN CENTENNIAL XG 350 V6 24 V	07/01-->10/06 06/00-->	195 PS / 143 KW 197 PS / 145 KW	G6CV	41416005  22311-39501 1,20mm FIBER / FIBRE  22311-39502 1,20mm FIBER / FIBRE ø94
-------------	--	---------------------------	------------------------------------	------	---

3,8 3800	6 CYL AZERA V6	2007-->2010			41520305   ø93,5
-------------	-------------------	-------------	--	--	--

▲ : İçerikte Bulunmamaktadır...

▲ : Not included in the set

▲ : Non inclus dans la pochette

00: Motor Takım Keçesiz ve Subap Lastiksiz







00: Gasket Set Without oil seals Without Valve Stem Seal

01: Motor Takım Keçesiz - Subap Lastikli

01: Gasket set With Valve Stem Seal Without Oil Seals

02: Motor Full Takım Keçeli ve Subap Lastikli

02: Gasket Full Set With oil seals and Valve Stem Seals

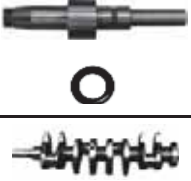
<p>Subap Kapak Valve Cover Gasket Zylinderkopfhaube Couvre-culbut.</p> 	<p>Karter Oil Pan Ölwanne Carter d'huile</p> 	<p>Emme Manifold Intake Manifold Ansaug Admission</p> 	<p>Egzoz Manifold Exhaust Manifold Auspuffkrümmer Collecteur D'echappement</p> 	<p>Eksoz Boğaz Exhaust Pipe Auspuff Kehle</p> 	<p>Supap Keçesi Valve Stem Seal Ventilschaft Queue de soupape</p> 	

■ : Delik - Çentik

■ : Hole - Notch

■ : Trou - Entaille

NOT: Katalogdaki Orijinal Kodlar Referans Amacıyla Kullanılmıştır.Lütfen Oto Conta Kodlarını Kullanınız.  
Original codes used for reference only.Please use OTO CONTA codes for orders.



IVECO

00



Silindir Kapak  
Cylinder Head

01



Zylinderkopf

02



Joint de culasse

03



04



Ltr	MODEL	PS/KW	ENGINE/MOTOR		
2,5 2499	4 CYL ø93 DAILY I	01/89--> 06/90-->	75 PS / 55 KW 72 PS / 53 KW 106 PS / 78 KW 109 PS / 80 KW 116 PS / 85 KW 104 PS / 77 KW 103 PS / 72 KW 98 PS / 68 KW	8140.07.2700 8140.07.2701 8140.07.2710 8140.07.2711 8140.07.2712 8140.07.2713 8140.07.3710 8140.07.3711 8140.07.3712 8140.07.3713 8140.21.200 8140.21.212 8140.27S.2801 8140.27S.2811 8140.27S.2885 8140.27S.3811 8140.27.215 8140.27.218	 <b>40138005</b> 98448817 1,50mm  <b>40138006</b> 99461499 1,40mm  <b>ø95</b>
2,5 2499	4 CYL ø93 DAILY II	01/89-->08/98	82 PS / 60 KW	8140.67F.3700 8140.67F.3701 8140.67F.3710 8140.67F.3711 8140.67F.3713	 <b>40147005</b> 98498291 1,80mm  <b>40147006</b> 98492581 1,70mm <b>ø95,2</b>
2,8 2799	4 CYL ø94,4 DAILY I DAILY II	05/96-->05/99	122 PS / 90 KW	8140.23.3700 8140.23.3701 8140.23.3710 8140.23.3711 8140.23.3713 8140.23.3720 8140.23.3721 8140.23.3730 8140.23.3731 8140.23.3750 8140.23.3751 8140.23.3760 8140.43	<b>40139000</b> 99477116  <b>40139005</b> 99458402 1,50mm  <b>40139006</b> 99460983 1,40mm  <b>40139007</b> 99432353 1,30mm <b>ø96</b>

▲ : İçerikte Bulunmamaktadır...

▲ : Not included in the set

▲ : Non inclus dans la pochette

00: Motor Takım Keçesiz ve Subap Lastiksiz













00: Gasket Set Without oil seals Without Valve Stem Seal

01: Motor Takım Keçesiz - Subap Lastikli

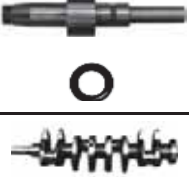
01: Gasket set With Valve Stem Seal Without Oil Seals

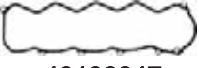
02: Motor Full Takım Keçeli ve Subap Lastikli

02: Gasket Full Set With oil seals and Valve Stem Seals

<p>Subap Kapak Valve Cover Gasket Zylinderkopfhaube Couvre-culbut.</p> 	<p>Karter Oil Pan Ölwanne Carter d'huile</p> 	<p>Emme Manifold Intake Manifold Ansaug Admission</p> 	<p>Egzoz Manifold Exhaust Manifold Auspuffkrümmer Collecteur D'echappement</p> 	<p>Eksoz Boğaz Exhaust Pipe Auspuff Kehle</p> 	<p>Supap Keçesi Valve Stem Seal Ventilschaft Queue de soupape</p> 	
 <p>40138045 500388382</p>  <p>40138047 500388381</p>	 <p>40146066 7301683</p>  <p>40138068 500327440</p>	 <p>40146019x4 98425767</p>	 <p>40147021x4 98434020</p>			

■ : Delik - Çentik

■ : Hole - Notch

■ : Trou - Entaille

NOT: Katalogdaki Orijinal Kodlar Referans Amacıyla Kullanılmıştır.Lütfen Oto Conta Kodlarını Kullanınız.  
Original codes used for reference only.Please use OTO CONTA codes for orders.



IVECO

00



Silindir Kapak  
Cylinder Head  
Zylinderkopf  
Joint de culasse

01



02



03



04



Ltr	MODEL	PS/KW	ENGINE/MOTOR		
2,8 2799	4 CYL ø94,4 DAILY II 05/96-->05/99	103 PS / 76 KW	8140.23.3801 8140.23.3811 8140.23.3821 8140.43B.4300 8140.43B...  8140.43K... 8140.43N... 8140.43N...  8140.43R... 8140.43S...		 <b>40139005</b> 99458402 1,50mm  <b>40139006</b> 99460983 1,40mm  <b>40139007</b> 99432353 1,30mm ø96
2,8 2799	4 CYL ø94,4 DAILY III 05/99-->	105 PS / 77 KW	8140.43C.4000 8140.43C.4005 8140.43C.4020 8140.43C.4021 8140.43C.4025  8140.43C.4026 8140.43C.4030 8140.43C.4031  8140.43C.4035 8140.43C.4036	<b>40139100</b> 500366511 	 <b>40139005</b> 99458402 1,50mm  <b>40139006</b> 99460983 1,40mm  <b>40139007</b> 99432353 1,30mm ø96
2,8 2799	4 CYL ø94,4 DAILY II DAILY III 09/98-->05/99	84 PS / 62 KW	8140.63.4000 8140.63.4020 8140.63.3711 8140.63.3713 8140.63.3721 8140.63.3723		 <b>40147105</b> 500306172 1,80mm  <b>40147106</b> 500306171 1,70mm  <b>40147107</b> 500306170 1,60mm ø96

▲ : İçerikte Bulunmamaktadır...

▲ : Not included in the set

▲ : Non inclus dans la pochette

00: Motor Takım Keçesiz ve Subap Lastiksiz













00: Gasket Set Without oil seals Without Valve Stem Seal

01: Motor Takım Keçesiz - Subap Lastikli

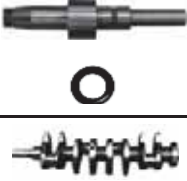
01: Gasket set With Valve Stem Seal Without Oil Seals

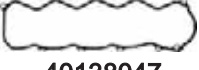
02: Motor Full Takım Keçeli ve Subap Lastikli

02: Gasket Full Set With oil seals and Valve Stem Seals

<p>Subap Kapak Valve Cover Gasket Zylinderkopfhaube Couvre-culbut.</p> 	<p>Karter Oil Pan Ölwanne Carter d'huile</p> 	<p>Emme Manifold Intake Manifold Ansaug Admission</p> 	<p>Egzoz Manifold Exhaust Manifold Auspuffkrümmer Collecteur D'echappement</p> 	<p>Eksoz Boğaz Exhaust Pipe Auspuff Kehle</p> 	<p>Supap Keçesi Valve Stem Seal Ventilschaft Queue de soupape</p> 	
 <p><b>40138045</b> 500388382</p>  <p><b>40138047</b> 500388381</p>	 <p><b>40138068</b> 98446492</p>	 <p><b>40146019x4</b> 98425767</p>	 <p><b>40147021x4</b> 98434020</p>			

■ : Delik - Çentik

■ : Hole - Notch

■ : Trou - Entaille

NOT: Katalogdaki Orijinal Kodlar Referans Amacıyla Kullanılmıştır.Lütfen Oto Conta Kodlarını Kullanınız.  
Original codes used for reference only.Please use OTO CONTA codes for orders.



IVECO

00



Silindir Kapak  
Cylinder Head

01



Zylinderkopf

02







Joint de culasse

03



04



Ltr	MODEL	PS/KW	ENGINE/MOTOR		
	3 CYL ø110 400 500				 <b>41316005</b> 8823404 ø114
4,2 4156	4 CYL ø105 LEONCINO 1960-->1969		C01D		 <b>41315005</b> 8804253 ø109
4,6 4561	4 CYL ø110 65NC-OM65- 1972-> 75NC-OM75 1973-> 70NC-OM70 1973-> OM50-OM55 1973->1978 329 A BUS 1973->1986 CERBIATTO 1969-> DAINO 1969-> LEONCINO 1969-> LUPETTO 1969-> 5,0 TIGROTTO 1969-> 4941 LEONCINO 1969-> LUPETTO 1969->		C03 C03 C03 C03 C03 C03 C03 C03 C03 C03 C03 C03		 <b>41411005</b> 8818558 ø114
4,0 4397	4 CYL ø108 / 110 CERBIATTO 1962->1969		C02D		 <b>41314005</b> 8807696 ø112
5,0	DAINO 1962->1969		C03D		
4941	LEONCINO 1962->1969		C02D		
	TIGROTTO 1962->1969		C03D		
11,6 11548	6 CYL ø130 300 BUS 1968-> 306 BUS 1968-> 682 N3/T3 1962->1976 682 N4/T4 1968->		203H61 203H61 203A/61 203A/61		 <b>41318006</b> 4868477 ø134

▲ : İçerikte Bulunmamaktadır...

▲ : Not included in the set

▲ : Non inclus dans la pochette

00: Motor Takım Keçesiz ve Subap Lastiksiz









00: Gasket Set Without oil seals Without Valve Stem Seal

01: Motor Takım Keçesiz - Subap Lastikli

01: Gasket set With Valve Stem Seal Without Oil Seals

02: Motor Full Takım Keçeli ve Subap Lastikli

02: Gasket Full Set With oil seals and Valve Stem Seals

Subap Kapak Valve Cover Gasket Zylinderkopfhaube Couvre-culbut.	Karter Oil Pan Ölwanne Carter d'huile	Emme Manifold Intake Manifold Ansaug Admission	Egzoz Manifold Exhaust Manifold Auspuffkrümmer Collecteur D'echappement	Eksoz Boğaz Exhaust Pipe Auspuff Kehle	Supap Keçesi Valve Stem Seal Ventilschaft Queue de soupape	  
						

■ : Delik - Çentik

■ : Hole - Notch

■ : Trou - Entaille

NOT: Katalogdaki Orijinal Kodlar Referans Amacıyla Kullanılmıştır.Lütfen Oto Conta Kodlarını Kullanınız.  
Original codes used for reference only.Please use OTO CONTA codes for orders.



JOHN DEERE

00



01



02



03



04



Silindir Kapak  
Cylinder Head  
Zylinderkopf  
Joint de culasse



Ltr	MODEL	PS/KW	ENGINE/MOTOR		
2,5 2490	3 CYL ø98 1020			41000900 RE-13255 RE-501574	
2,6 2697	3 CYL ø102 1030 1035 1520			41000903 AR102295	41000905 R-98460 R-52790 ø115
2,9 2938	3 CYL ø106,5 1630 1635 330				
2,5 2490	3 CYL ø98 1020 JD300 JD301 JD350 JD820 JD830		3152 D	41001000 RE-16912	
2,6 2697	3 CYL ø102 1030 1035 1520 1530 204 JD302		3164 D	41001000 RE-16912	
2,9 2938	3 CYL ø106,5 1630 1635 1040 1140 330 2040 2240 5105 5200 5300		3179 D 3029 D 3029 D 3029 T	41001000 RE-16912	
3,3 3310	4 CYL ø98 2020	4202DL01		42434000 AR-103456 RE-38558	
				42434003 RE-38847	42434005 R-52790 R-98461 ø115

▲ : İçerikte Bulunmamaktadır...

▲ : Not included in the set

▲ : Non inclus dans la pochette

00: Motor Takım Keçesiz ve Subap Lastiksiz











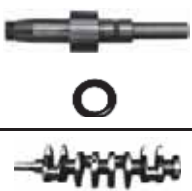









00: Gasket Set Without oil seals Without Valve Stem Seal

01: Motor Takım Keçesiz - Subap Lastikli

01: Gasket set With Valve Stem Seal Without Oil Seals

02: Motor Full Takım Keçeli ve Subap Lastikli

02: Gasket Full Set With oil seals and Valve Stem Seals

Subap Kapak Valve Cover Gasket Zylinderkopfhaube Couvre-culbut.	Karter Oil Pan Ölwanne Carter d'huile	Emme Manifold Intake Manifold Ansaug Admission	Egzoz Manifold Exhaust Manifold Auspuffkrümmer Collecteur D'echappement	Eksoz Boğaz Exhaust Pipe Auspuff Kehle	Supap Keçesi Valve Stem Seal Ventilschaft Queue de soupape	
						
<b>41001058</b> R-75729 T-20111	<b>41001010</b> T-24534		<b>41001020x3</b> T-20006			
						
<b>41001058</b> R-75729	<b>41001010</b> T-24534		<b>41001020x3</b> T-20006			
						
<b>41001058</b> R-75729	<b>41001010</b> T-24534		<b>41001020x3</b> T-20006			
						
<b>41001058</b> R-75729	<b>41001010</b> T-24534		<b>41001020x3</b> T-20006			
						
<b>41002033</b> T-20075 R-73521	<b>41002008</b> R-49515 R-123353		<b>41001020x4</b> T-20006			

■ : Delik - Çentik

■ : Hole - Notch

■ : Trou - Entaille

NOT: Katalogdaki Orijinal Kodlar Referans Amacıyla Kullanılmıştır. Lütfen Oto Conta Kodlarını Kullanınız.  
Original codes used for reference only. Please use OTO CONTA codes for orders.



JOHN DEERE

00



01



02



03



04



Silindir Kapak  
Cylinder Head  
Zylinderkopf  
Joint de culasse



Ltr	MODEL	PS/KW	ENGINE/MOTOR		
3,3 3310	4 CYL ø98 2020 2510 JD400 JD440 JD450 JD480		4202DL01/4180	<b>41002000</b> AR-71998 RE-38857 <b>41002003</b> AR-71992 RE-38851	 <b>41002005</b> R-92425 R-56573 <b>ø119</b>
3,5 3590	4 CYL ø102 2120 2030 2035		4219 D	<b>42434000</b> AR-103456 RE-38558 <b>42434003</b> RE-38847	 <b>42434005</b> R-52790 R-98461 <b>ø115</b>
3,5 3310	4 CYL ø102 2120 2030 2035 2270; 2280 2340; 2420 JD310; JD401		4219 D	<b>41002000</b> AR-71998 RE-38857 <b>41002003</b> AR-71992 RE-38851	 <b>41002005</b> R-92425 R-56573 <b>ø119</b>
3,9 3918	4 CYL ø106,5 2130 2135 935			<b>42434000</b> AR-103456 RE-38558 <b>42434003</b> RE-38847	 <b>42434005</b> R-52790 R-98461 <b>ø115</b>
3,9 3918	4 CYL ø106,5 2130; 2135 1640; 1840; 2040 2140; 2650 2850; 2250; 2450 935; 940 JD4400; JD540B JD550; JD555		4239 D 4239 T	<b>41002000</b> AR-71998 RE-38857 <b>41002003</b> AR-71992 RE-38851	 <b>41002005</b> R-92425 R-56573 <b>ø119</b>

▲ : İçerikte Bulunmamaktadır...

▲ : Not included in the set

▲ : Non inclus dans la pochette

00: Motor Takım Keçesiz ve Subap Lastiksiz











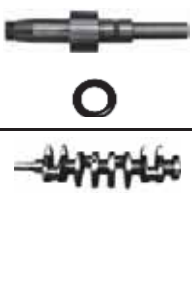











00: Gasket Set Without oil seals Without Valve Stem Seal

01: Motor Takım Keçesiz - Subap Lastikli

01: Gasket set With Valve Stem Seal Without Oil Seals

02: Motor Full Takım Keçeli ve Subap Lastikli

02: Gasket Full Set With oil seals and Valve Stem Seals

Subap Kapak Valve Cover Gasket Zylinderkopfhaube Couvre-culbut.	Karter Oil Pan Ölwanne Carter d'huile	Emme Manifold Intake Manifold Ansaug Admission	Egzoz Manifold Exhaust Manifold Auspuffkrümmer Collecteur D'echappement	Eksoz Boğaz Exhaust Pipe Auspuff Kehle	Supap Keçesi Valve Stem Seal Ventilschaft Queue de soupape	
						
 <b>41002033</b> T-20075 R-73521	 <b>41002008</b> R-49515 R-123353		 <b>41001020x4</b> T-20006			
 <b>41002033</b> T-20075 R-73521	 <b>41002008</b> R-49515 R-123353		 <b>41001020x4</b> T-20006			
 <b>41002033</b> T-20075 R-73521	 <b>41002008</b> R-49515 R-123353		 <b>41001020x4</b> T-20006			
 <b>41002033</b> T-20075 R-73521	 <b>41002008</b> R-49515 R-123353		 <b>41001020x4</b> T-20006			
 <b>41002033</b> T-20075 R-73521	 <b>41002008</b> R-49515 R-123353		 <b>41001020x4</b> T-20006			

■ : Delik - Çentik

■ : Hole - Notch

■ : Trou - Entaille

NOT: Katalogdaki Orijinal Kodlar Referans Amacıyla Kullanılmıştır.Lütfen Oto Conta Kodlarını Kullanınız.  
Original codes used for reference only.Please use OTO CONTA codes for orders.



JOHN DEERE

00



01



02



03



04



Silindir Kapak  
Cylinder Head  
Zylinderkopf  
Joint de culasse



Ltr	MODEL	PS/KW	ENGINE/MOTOR		
3,7	4 CYL ø101,6 JD500 3010 JD510 3020  4 CYL ø101,8 JD500A JD500B JD500C JD510		3010 3010 3020 3020  227/4270D 227/4270D 227/4270D 227/4270D	42433400 AR-53033  42433403 AR-53032	 42433405 R-45616 ø122,5
3,7	4 CYL ø101,6 JD510 3020		3020	42433300 AR-53035  42433303 AR-53034	 42433305 R-48292 ø124,5

▲ : İçerikte Bulunmamaktadır...

▲ : Not included in the set

▲ : Non inclus dans la pochette

00: Motor Takım Keçesiz ve Subap Lastiksiz











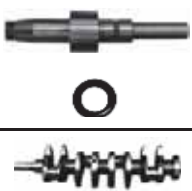





00: Gasket Set Without oil seals Without Valve Stem Seal

01: Motor Takım Keçesiz - Subap Lastikli

01: Gasket set With Valve Stem Seal Without Oil Seals

02: Motor Full Takım Keçeli ve Subap Lastikli

02: Gasket Full Set With oil seals and Valve Stem Seals

Subap Kapak Valve Cover Gasket Zylinderkopfhaube Couvre-culbut.	Karter Oil Pan Ölwanne Carter d'huile	Emme Manifold Intake Manifold Ansaug Admission	Egzoz Manifold Exhaust Manifold Auspuffkrümmer Collecteur D'echappement	Eksoz Boğaz Exhaust Pipe Auspuff Kehle	Supap Keçesi Valve Stem Seal Ventilschaft Queue de soupape	
						
 42433334 R-49865	 42433308 R-71917	 42433718x2 R-26297	 42432122x2 R-83020  42432121x2 R-83021			
 42433334 R-49865	 42433308 R-71917	 42433718x2 R-26297	 42432122x2 R-83020  42432121x2 R-83021			

■ : Delik - Çentik

■ : Hole - Notch

■ : Trou - Entaille

NOT: Katalogdaki Orijinal Kodlar Referans Amacıyla Kullanılmıştır.Lütfen Oto Conta Kodlarını Kullanınız.  
Original codes used for reference only.Please use OTO CONTA codes for orders.



JOHN DEERE

00



01



02



03



04



Silindir Kapak  
Cylinder Head  
Zylinderkopf  
Joint de culasse



Ltr	MODEL	PS/KW	ENGINE/MOTOR		
4,5 4500	4 CYL ø106 280 310G 340D 344E 410C 410D 440C 450 450H 550 H 650 H 2630 - 2640 - 5410 5420 N 5420 5510 N 5510 - 5520 - 6010 5520 N 6020 6110 6120 6205 6210 6220 6310 6400 6405 6410 6415 6505 6510 6700		4045 D 4045 T 4045 H 4045 HL 4045 TF	42432000 RE-501455  42432003 RE-660282	  42432005 R-116515 ø119
5,4 5395	6 CYL ø102 3120; 3130; 3135 2840;630; 730; 950 960; 970 JD303; JD444; JD540 JD544; JD570; JD482 484; 499; 699 4420; 6600		6329 D	42432600 RE-527022  41003003 AR-71994 RE-38852	  41003005 R-59449 ø119

▲ : İçerikte Bulunmamaktadır...

▲ : Not included in the set

▲ : Non inclus dans la pochette

00: Motor Takım Keçesiz ve Subap Lastiksiz











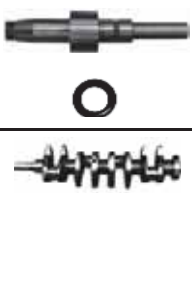





00: Gasket Set Without oil seals Without Valve Stem Seal

01: Motor Takım Keçesiz - Subap Lastikli

01: Gasket set With Valve Stem Seal Without Oil Seals

02: Motor Full Takım Keçeli ve Subap Lastikli

02: Gasket Full Set With oil seals and Valve Stem Seals

Subap Kapak Valve Cover Gasket Zylinderkopfhaube Couvre-culbut.	Karter Oil Pan Ölwanne Carter d'huile	Emme Manifold Intake Manifold Ansaug Admission	Egzoz Manifold Exhaust Manifold Auspuffkrümmer Collecteur D'echappement	Eksoz Boğaz Exhaust Pipe Auspuff Kehle	Supap Keçesi Valve Stem Seal Ventilschaft Queue de soupape	
						
 <b>42432025</b> R-123542	 <b>41002008</b> R-49515 R-123353   <b>42432008</b> R-123352			 <b>41003017</b> R-55509 R-89879   <b>42432821x4</b> R-521439		
 <b>41003033</b> T-20467 R-75728	 <b>41003008</b> T-20205 R-97349	 <b>41001088x2</b> T-20159	 <b>41001020x6</b> T-20006   <b>41003017</b> R-55509 R-89879			

■ : Delik - Çentik

■ : Hole - Notch

■ : Trou - Entaille

NOT: Katalogdaki Orijinal Kodlar Referans Amacıyla Kullanılmıştır.Lütfen Oto Conta Kodlarını Kullanınız.  
Original codes used for reference only.Please use OTO CONTA codes for orders.



JOHN DEERE

00



01



02



03



04



Silindir Kapak  
Cylinder Head  
Zylinderkopf  
Joint de culasse



Ltr	MODEL	PS/KW	ENGINE/MOTOR		
5,4 5395	6 CYL ø102 3120 3130 3135 630 730 950 960; 970			41002900 Motor Takım Conta Gasket Set  41002903 Motor Üst Takım Gasket Head Set	  41002905 R-52791 ø115
5,4 5395	6 CYL ø102 955 4240 4440 4040 965 955H 985 1065 1068H 4040S 4240S		3029 D 3029 T 6359 D 6359 T	41003000 AR-74367 AR-102268 AR-97786  41003003 RE-38852 AR-71994	  41003005 R-59449 ø119
5,9 5880	6 CYL ø106,5 3140; 3040 3640; 4040 960; 970; 975 2940; 3050 3350; 3650 JD544B; JD640; JD655 JD670; JD672; JD750 JD755		6359 D 6414 D	42432600 RE-527022  41003003 AR-71994 RE-38852	  41003005 R-59449 ø119
6,6 6600	6 CYL ø101,6 JD600 4010  6 CYL ø104,7 JD600 4020  6 CYL ø108 7700; 7720; JD644 341; 362; 6620; 6622  << 214999		4010/301 4010  381 4020  6404 6404	42424100 AR-53626  42434103 AR-53625	  42434105 R-45615 ø122,5

▲ : İçerikte Bulunmamaktadır...

▲ : Not included in the set

▲ : Non inclus dans la pochette

00: Motor Takım Keçesiz ve Subap Lastiksiz







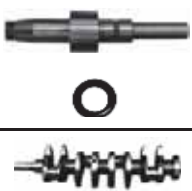

00: Gasket Set Without oil seals Without Valve Stem Seal

01: Motor Takım Keçesiz - Subap Lastikli

01: Gasket set With Valve Stem Seal Without Oil Seals

02: Motor Full Takım Keçeli ve Subap Lastikli

02: Gasket Full Set With oil seals and Valve Stem Seals

Subap Kapak Valve Cover Gasket Zylinderkopfhaube Couvre-culbut.	Karter Oil Pan Ölwanne Carter d'huile	Emme Manifold Intake Manifold Ansaug Admission	Egzoz Manifold Exhaust Manifold Auspuffkrümmer Collecteur D'échappement	Eksoz Boğaz Exhaust Pipe Auspuff Kehle	Supap Keçesi Valve Stem Seal Ventilschaft Queue de soupape	
						
<b>41003033</b> T-20467 R-75728	<b>41003008</b> T-20205 R-97349	<b>41001088x2</b> T-20159	<b>41001020x6</b> T-20006  <b>41003017</b> R-55509 R-89879			
<b>41003033</b> T-20467 R-75728	<b>41003008</b> T-20205 R-97349	<b>41001088x2</b> T-20159	<b>41001020x6</b> T-20006  <b>41003017</b> R-55509 R-89879			
<b>41003033</b> T-20467 R-75728	<b>41003008</b> T-20205 R-97349	<b>41001088x2</b> T-20159	<b>41001020x6</b> T-20006  <b>41003017</b> R-55509 R-89879			
<b>42432134</b> R-49866	<b>42432108</b> R-71918 R-520583	<b>42433718x3</b> R-26297	<b>42432122x2</b> R-83020  <b>42432121x2</b> R-83021			

■ : Delik - Çentik

■ : Hole - Notch

■ : Trou - Entaille

NOT: Katalogdaki Orijinal Kodlar Referans Amacıyla Kullanılmıştır. Lütfen Oto Conta Kodlarını Kullanınız.  
Original codes used for reference only. Please use OTO CONTA codes for orders.



JOHN DEERE

00



01



02



03



04



Silindir Kapak  
Cylinder Head  
Zylinderkopf  
Joint de culasse



Ltr	MODEL	PS/KW	ENGINE/MOTOR		
6,6 6600	6 CYL ø101,6 JD600 4010  6 CYL ø104,7 JD600 4020  6 CYL ø108 7700; 7720; JD644 341; 362; 6620; 6622  >>215000-335845		4010/301 4010  381 4020  6404 6404	42433600 AR-53631  42433603 AR-53630	  42432105 R-48291 ø124,5
6,6 6600	6 CYL ø108 4520 JD690B; JD693B JD740 ; 4040; 4249 4440; 5440 5640; 7020 7720; 4430 4620; 4630; 4320		4520/6404A/D/T	42432100 RG-27875  42432103 RG-27876 AR-63270	  42432105 R-48291 ø124,5

▲ : İçerikte Bulunmamaktadır...

▲ : Not included in the set

▲ : Non inclus dans la pochette

00: Motor Takım Keçesiz ve Subap Lastiksiz











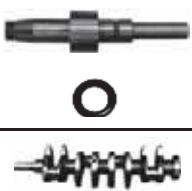





00: Gasket Set Without oil seals Without Valve Stem Seal

01: Motor Takım Keçesiz - Subap Lastikli

01: Gasket set With Valve Stem Seal Without Oil Seals

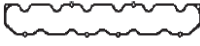
02: Motor Full Takım Keçeli ve Subap Lastikli

02: Gasket Full Set With oil seals and Valve Stem Seals

Subap Kapak Valve Cover Gasket Zylinderkopfhaube Couvre-culbut.	Karter Oil Pan Ölwanne Carter d'huile	Emme Manifold Intake Manifold Ansaug Admission	Egzoz Manifold Exhaust Manifold Auspuffkrümmer Collecteur D'echappement	Eksoz Boğaz Exhaust Pipe Auspuff Kehle	Supap Keçesi Valve Stem Seal Ventilschaft Queue de soupape	
						
 <b>42432134</b> R-49866	 <b>42432108</b> R-71918 R-520583	 <b>42433718x3</b> R-26297	 <b>42432122x2</b> R-83020  <b>42432121x2</b> R-83021			
 <b>42432134</b> R-49866	 <b>42432108</b> R-71918 R-520583	 <b>42433718x3</b> R-26297	 <b>42432122x2</b> R-83020  <b>42432121x2</b> R-83021			

■ : Delik - Çentik

■ : Hole - Notch

■ : Trou - Entaille

NOT: Katalogdaki Orijinal Kodlar Referans Amacıyla Kullanılmıştır.Lütfen Oto Conta Kodlarını Kullanınız.  
Original codes used for reference only.Please use OTO CONTA codes for orders.



JOHN DEERE

00



01



02



03



04



Silindir Kapak  
Cylinder Head  
Zylinderkopf  
Joint de culasse



Ltr	MODEL	PS/KW	ENGINE/MOTOR		
6,8	6 CYL ø106				
6800	JD670	Tractor :			
	JD755	6215 / 6320 / 6420	6068 H	42432200	
	LX100-2	6510 / 6515 / 6520	6068 T	RE-501456	
	42.14	6605 / 6610 / 6615		42432203	
	360DC	6715 / 6810 / 6820		RE-66083	
	360DG	6910S / 6920 / 6920S			
	430B	7220 / 7320 / 7400			
	460DC	7420 / 7510 / 7520			
	460DG	7610 / 7710 / 7810			
	540G	6505 / 6603 / 6620			
	544J	6910 / 7210 / 7410 / 7600			
	548G				
	624EH				
	624G				
	640E				
	640G				
	648G				
	653E				
	653G				
	690				
	700H				
	700J				
	710D				
	710J				
	750C				
	750J				
	790E				
	850J				
	1070D				
	1110D				
	1410D				
	1450				
	1490D				
	1550				
	2054				
	2054				
	2254				
	2254				
	4710				
	4990				
	4995				
	7455				
	7460				
	9400				
	9410				
	9540				
	9560				
	9580				
	9935				

▲ : İçerikte Bulunmamaktadır...

▲ : Not included in the set

▲ : Non inclus dans la pochette

00: Motor Takım Keçesiz ve Subap Lastiksiz











00: Gasket Set Without oil seals Without Valve Stem Seal

01: Motor Takım Keçesiz - Subap Lastikli

01: Gasket set With Valve Stem Seal Without Oil Seals

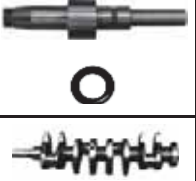
02: Motor Full Takım Keçeli ve Subap Lastikli

02: Gasket Full Set With oil seals and Valve Stem Seals

<p>Subap Kapak Valve Cover Gasket Zylinderkopfhaube Couvre-culbut.</p> 	<p>Karter Oil Pan Ölwanne Carter d'huile</p> 	<p>Emme Manifold Intake Manifold Ansaug Admission</p> 	<p>Egzoz Manifold Exhaust Manifold Auspuffkrümmer Collecteur D'echappement</p> 	<p>Eksoz Boğaz Exhaust Pipe Auspuff Kehle</p> 	<p>Supap Keçesi Valve Stem Seal Ventilschaft Queue de soupape</p> 	
 <p><b>42432225</b> R-123543</p>	 <p><b>41003008</b> T-20205 R-123354</p>		 <p><b>41003017</b> R-55509 R-89879</p>  <p><b>42432821x6</b> R-521439</p>			

■ : Delik - Çentik

■ : Hole - Notch

■ : Trou - Entaille

NOT: Katalogdaki Orijinal Kodlar Referans Amacıyla Kullanılmıştır. Lütfen Oto Conta Kodlarını Kullanınız.  
Original codes used for reference only. Please use OTO CONTA codes for orders.



JOHN DEERE

00



Silindir Kapak  
Cylinder Head  
Zylinderkopf  
Joint de culasse

01



02



03



04



Ltr MODEL PS/KW ENGINE/MOTOR

Ltr	MODEL	PS/KW	ENGINE/MOTOR		
7,6	6 CYL ø116				
7600	220LC		6076	42433700	
	540E		6076 A	RE-524624	
	548E		6076 H	AR-101276	
	548G		6076 T		42433705
	640E				RE-47336
	640G			42433703	R-66065
	648E			RE-526730	ø129
	648G			RG-27884	
	740E				
	740G				
	748G				
	1185				
	2440				
	4255				
	4455				
	4555				
	4560				
	4755				
	4760				
	4955				
	4960				
	6076-AG				
	7700				
	7700				
	7800				
	8100				
	8200				
	8300				
	8560				
	8570				
	9500				
	9600				
	9960				
	9965				

▲ : İçerikte Bulunmamaktadır...

▲ : Not included in the set

▲ : Non inclus dans la pochette

00: Motor Takım Keçesiz ve Subap Lastiksiz













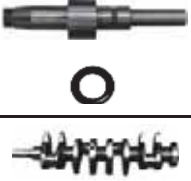
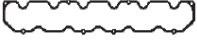

00: Gasket Set Without oil seals Without Valve Stem Seal

01: Motor Takım Keçesiz - Subap Lastikli

01: Gasket set With Valve Stem Seal Without Oil Seals

02: Motor Full Takım Keçeli ve Subap Lastikli

02: Gasket Full Set With oil seals and Valve Stem Seals

<p>Subap Kapak Valve Cover Gasket Zylinderkopfhaube Couvre-culbut.</p> 	<p>Karter Oil Pan Ölwanne Carter d'huile</p> 	<p>Emme Manifold Intake Manifold Ansaug Admission</p> 	<p>Egzoz Manifold Exhaust Manifold Auspuffkrümmer Collecteur D'echappement</p> 	<p>Eksoz Boğaz Exhaust Pipe Auspuff Kehle</p> 	<p>Supap Keçesi Valve Stem Seal Ventilschaft Queue de soupape</p> 	
 <p><b>42432134</b> R-49866</p>	 <p><b>42432108</b> R-71918 R-520583</p>  <p><b>42432109</b> R-49377 R-521228</p>	 <p><b>42433819x3</b> R-130573</p>	 <p><b>42432122x2</b> R-83020</p>  <p><b>42432121x2</b> R-83021</p>	 <p><b>41003017</b> R-55509 R-89879</p>  <p><b>42432518</b> R-92097 R-123583</p>		

■ : Delik - Çentik

■ : Hole - Notch

■ : Trou - Entaille

NOT: Katalogdaki Orijinal Kodlar Referans Amacıyla Kullanılmıştır.Lütfen Oto Conta Kodlarını Kullanınız.  
Original codes used for reference only.Please use OTO CONTA codes for orders.



JOHN DEERE

00



Silindir Kapak  
Cylinder Head  
Zylinderkopf  
Joint de culasse

01



02



03



04



Ltr	MODEL	PS/KW	ENGINE/MOTOR		
7,6 7600	6 CYL ø116 Series 500 644C 644D 690 762A 762B 770 770A 770B 4050 4250 4350 4440 4450 4640 4650 4755 4760 4840 4850 4955 4960 5720 5730 6620 6622 7720 8430 8440 8450 8560 8820 9940 9950		6466 A 6466 T	42433800 RE-524404  42433803 RE-524409	  42433705 RE-47336 R-66065 ø129
8,7 8700	6 CYL ø120 JD644B JD646 JD646B Series 770 770A 772A		6531 A 6531 T	42433900 RE-524149 RE-17050  42433903 RE-524148 AR-67510	  42433905 R-78513 ø138

▲ : İçerikte Bulunmamaktadır...

▲ : Not included in the set

▲ : Non inclus dans la pochette

00: Motor Takım Keçesiz ve Subap Lastiksiz











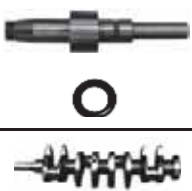









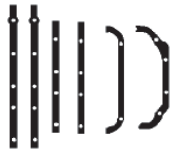

00: Gasket Set Without oil seals Without Valve Stem Seal

01: Motor Takım Keçesiz - Subap Lastikli

01: Gasket set With Valve Stem Seal Without Oil Seals

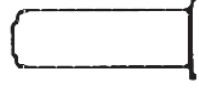
02: Motor Full Takım Keçeli ve Subap Lastikli

02: Gasket Full Set With oil seals and Valve Stem Seals

Subap Kapak Valve Cover Gasket Zylinderkopfhaube Couvre-culbut.	Karter Oil Pan Ölwanne Carter d'huile	Emme Manifold Intake Manifold Ansaug Admission	Egzoz Manifold Exhaust Manifold Auspuffkrümmer Collecteur D'echappement	Eksoz Boğaz Exhaust Pipe Auspuff Kehle	Supap Keçesi Valve Stem Seal Ventilschaft Queue de soupape	
						
 <b>42432134</b> R-49866	 <b>42432108</b> R-71918 R-520583   <b>42432109</b> R-49377 R-521228	 <b>42433819x3</b> R-130573   <b>42432118x3</b> R-50397	 <b>42432122x2</b> R-83020   <b>42432121x2</b> R-83021   <b>42432143</b> R-43751	 <b>41003017</b> R-55509 R-89879   <b>42432518</b> R-92097 R-123583		
 <b>42433934</b> R-47365 R-49867	 <b>42433908</b> R-56325 R-520584	 <b>42433517x3</b> R-520521 R-40088	 R-80969x2   R-80970x2  <b>42433521x2</b> R-80970 + R-80969	 <b>41003017</b> R-55509 R-89879		

■ : Delik - Çentik

■ : Hole - Notch

■ : Trou - Entaille

NOT: Katalogdaki Orijinal Kodlar Referans Amacıyla Kullanılmıştır.Lütfen Oto Conta Kodlarını Kullanınız.  
Original codes used for reference only.Please use OTO CONTA codes for orders.



JOHN DEERE

00



01



02



03



04



Silindir Kapak  
Cylinder Head  
Zylinderkopf  
Joint de culasse



Ltr	MODEL	PS/KW	ENGINE/MOTOR		
8,1	6 CYL ø116				
8100	330CR		6081 T	42432700	
	330LC		6081 H	RE-527579	
	370			RE-506220	
	530B				
	560D			42432703	
	608			RE-527550	
	644			RE-506222	
	660D				
	724J				
	740G				
	742J				
	753G				
	762				
	770D				
	850C				
	850J				
	870D				
	2256				
	2258				
	2266				
	6650				
	6710				
	7710				
	7810				
	7820				
	7920				
	8100				
	8110				
	8120				
	8200				
	8210				
	8220				
	8220T				
	8300				
	8310				
	8320				
	8400				
	8420				
	9450				
	9510/SH				
	9550/SH				
	9560				
	9580				
	9610				
	9640				
	9650				
	9650/CTS/STS				
	9660 / 9860 / 9960 / 9970				
	9750 STS				

▲ : İçerikte Bulunmamaktadır...

▲ : Not included in the set

▲ : Non inclus dans la pochette

00: Motor Takım Keçesiz ve Subap Lastiksiz













00: Gasket Set Without oil seals Without Valve Stem Seal

01: Motor Takım Keçesiz - Subap Lastikli

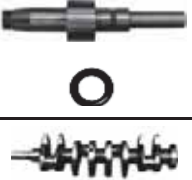
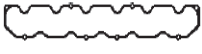
01: Gasket set With Valve Stem Seal Without Oil Seals

02: Motor Full Takım Keçeli ve Subap Lastikli

02: Gasket Full Set With oil seals and Valve Stem Seals

<p>Subap Kapak Valve Cover Gasket Zylinderkopfhaube Couvre-culbut.</p> 	<p>Karter Oil Pan Ölwanne Carter d'huile</p> 	<p>Emme Manifold Intake Manifold Ansaug Admission</p> 	<p>Egzoz Manifold Exhaust Manifold Auspuffkrümmer Collecteur D'echappement</p> 	<p>Eksoz Boğaz Exhaust Pipe Auspuff Kehle</p> 	<p>Supap Keçesi Valve Stem Seal Ventilschaft Queue de soupape</p> 	
 <p><b>42432134</b> R-49866</p>	 <p><b>42432708</b> R-521228</p>	 <p><b>42433819x6</b> R-130573 R-120646</p>	 <p><b>42432122x2</b> R-62776</p>  <p><b>42432121x2</b> R-83021</p>	 <p><b>41003017</b> R-55509 R-89879</p>		

■ : Delik - Çentik

■ : Hole - Notch

■ : Trou - Entaille

NOT: Katalogdaki Orijinal Kodlar Referans Amacıyla Kullanılmıştır.Lütfen Oto Conta Kodlarını Kullanınız.  
Original codes used for reference only.Please use OTO CONTA codes for orders.



KIA

00



Silindir Kapak  
Cylinder Head

01



Zylinderkopf

02



Joint de culasse

03



04



Ltr	MODEL	PS/KW	ENGINE/MOTOR		
1,0 999 1,1 1086	4 CYL ø66 PICANTO 12 V 04/04--> PICANTO EPSILON 12 V ( SOCH )	65 PS / 48 KW 61 PS / 45 KW	G4HE G4HG		 <b>41410405</b> 22311-02760 1,20mm FIBER / FIBRE ø68
1,3 1323	4 CYL ø71 PRIDE 01/90--> ( SOCH )	69 PS / 51 KW	B3		 <b>41410605</b> B302-10-271 1,60mm <b>41410606</b> B302-10-271 2,00mm ø74
1,3 1343	4 CYL ø75,5 RIO 08/00-->02/05 ( SOCH )	82 PS / 60 KW 75 PS / 50 KW	B3		 <b>41410105</b> OK30C 10 271A 1,20mm FIBER / FIBRE ø76,5
1,4 1399	4 CYL ø75,5 RIO 16 V 03/05--> ( DOCH )	97 PS / 71 KW	G4EE		 <b>41410505</b> 22311-26603 1,20mm FIBER / FIBRE ø77

▲ : İçerikte Bulunmamaktadır...

▲ : Not included in the set

▲ : Non inclus dans la pochette

00: Motor Takım Keçesiz ve Subap Lastiksiz

00: Gasket Set Without oil seals Without Valve Stem Seal

01: Motor Takım Keçesiz - Subap Lastikli

01: Gasket set With Valve Stem Seal Without Oil Seals

02: Motor Full Takım Keçeli ve Subap Lastikli

02: Gasket Full Set With oil seals and Valve Stem Seals





KIA

00



Silindir Kapak  
Cylinder Head  
Zylinderkopf  
Joint de culasse

01



02



03



04



Ltr	MODEL	PS/KW	ENGINE/MOTOR		
1,4 1396	4 CYL ø77mm CEE'D PRO CEE'D 12/06-->08/08	109 PS / 80 KW	G4FA		 <b>41510105</b> 22311-2B000 1,20mm FIBER/ FIBRE ø78,5
1,4 1396	4 CYL ø77mm CEE'D PRO CEE'D 09/08-->	109 PS / 80 KW	G4FA		 <b>41510106</b> 22311-2B003 1,20mm FIBER / FIBRE ø78,5
1,5 1493	4 CYL ø75,5 RIO 16 V ( DOCH ) 09/02-->02/05	97 PS / 71 KW	A3E B3 16V		 <b>41410205</b> OK30E1 10 271A 1,20mm FIBER / FIBRE ø76,5
1,5 1498	4 CYL ø78 SEPHIA AVELLA LEO MENTOR ( SOCH ) 02/96-->10/97	80 PS / 59 KW	B5		 <b>41480205</b> OB61L10271A 1,30mm ø79,5
1,6 1597	4 CYL ø78 SEPHIA MENTOR SEPHIA 16 V ( SOCH ) 09/93-->10/97	80 PS / 59 KW	B6		 <b>41480205</b> OB61L10271A 1,30mm ø79,5
1,6 1599	4 CYL ø76,5 CERATO 16V RIO 16V 02/04-->10/06	105 PS / 77 KW	G4ED		 <b>41410505</b> 22311-26603 1,20mm FIBER / FIBRE ø77

▲ : İçerikte Bulunmamaktadır...

▲ : Not included in the set

▲ : Non inclus dans la pochette

00: Motor Takım Keçesiz ve Subap Lastiksiz











00: Gasket Set Without oil seals Without Valve Stem Seal

01: Motor Takım Keçesiz - Subap Lastikli

01: Gasket set With Valve Stem Seal Without Oil Seals

02: Motor Full Takım Keçeli ve Subap Lastikli

02: Gasket Full Set With oil seals and Valve Stem Seals

Subap Kapak Valve Cover Gasket Zylinderkopfhaube Couverculbut.	Karter Oil Pan Ölwanne Carter d'huile	Emme Manifold Intake Manifold Ansaug Admission	Egzoz Manifold Exhaust Manifold Auspuffkrümmer Collecteur D'echappement	Eksoz Boğaz Exhaust Pipe Auspuff Kehle	Supap Keçesi Valve Stem Seal Ventilschaft Queue de soupape	  
						

■ : Delik - Çentik

■ : Hole - Notch

■ : Trou - Entaille

NOT: Katalogdaki Orijinal Kodlar Referans Amacıyla Kullanılmıştır.Lütfen Oto Conta Kodlarını Kullanınız.  
 Original codes used for reference only.Please use OTO CONTA codes for orders.



KIA

00



Silindir Kapak  
Cylinder Head

01



Zylinderkopf

02



Joint de culasse

03



04



Ltr	MODEL	PS/KW	ENGINE/MOTOR		
1,6 1591	4 CYL ø77mm CEE'D PRO CEE'D CERATO 05/06-->10/08	122 PS / 90 KW 115 PS / 85 KW 126 PS / 93 KW	G4FC		 <b>41510105</b> 22311-2B000 1,20mm FIBER/ FIBRE ø78,5
1,6 1591	4 CYL ø77mm CEE'D PRO CEE'D CERATO SOUL CARENS 11/08-->	122 PS / 90 KW 126 PS / 93 KW 115 PS / 85 KW 132 PS / 97 KW	G4FC		 <b>41510106</b> 22311-2B003 1,20mm FIBER / FIBRE ø78,5
2,0 1975	4 CYL ø82 SPECTRA 16V CERATO 16V SPORTAGE 16V CARENS II 16V CEE'D 16 V ( DOCH ) 04/04-->	143 PS / 105 KW 141 PS / 104 KW 139 PS / 102 KW	G4GC		 <b>41418005</b> 22311-23700 1,20mm FIBER / FIBRE ø84
2,0 1997	4 CYL ø85 OPTIMA 16V MAGENTIS 16V 05/01-->	136 PS / 100 KW	G4JP		 <b>41510005</b> 22311-38100 1,20mm FIBER / FIBRE ø86
2,0 1998	4 CYL ø86 SPORTAGE ( SOCH ) 04/94-->08/99	95 PS / 70 KW	FE (8V)		 <b>41420305</b> F202-10-271 1,40mm  <b>41420306</b> F202-10-271 1,80mm ø87,5

▲ : İçerikte Bulunmamaktadır...

▲ : Not included in the set

▲ : Non inclus dans la pochette

00: Motor Takım Keçesiz ve Subap Lastiksiz

00: Gasket Set Without oil seals Without Valve Stem Seal

01: Motor Takım Keçesiz - Subap Lastikli

01: Gasket set With Valve Stem Seal Without Oil Seals

02: Motor Full Takım Keçeli ve Subap Lastikli

02: Gasket Full Set With oil seals and Valve Stem Seals





KIA

00



01



02



03



04



Silindir Kapak  
Cylinder Head  
Zylinderkopf  
Joint de culasse



Ltr	MODEL	PS/KW	ENGINE/MOTOR		
2,0 1998	4 CYL ø86 SPORTAGE 16V RETONA 16V CLARUS 16V ( DOCH )	04/94--> 133 PS / 98 KW 128 PS / 94 KW	FE		 <b>41410305</b> OK013 10 271 1,20mm FIBER / FIBRE ø87,5
2,2 2184	4 CYL ø86 BESTA D RETONA TD SPORTAGE TD	02/96--> 65 PS / 48 KW 83 PS / 61 KW	R2 RF	<b>41410000</b> RF01-99-100	 <b>41410005</b> R201-10-271A ø87,5
2,2 2,200	4 CYL ø88,9 CERES	1979-->1981 89 PS / 70 KW	S2	<b>41480000</b> 0527-99-100	 <b>41480005</b> 0527-10-271A ø97
2,4 2,400	4 CYL ø92 CERES	1973-->1977 81 PS / 77 KW	XA XB	<b>41480000</b> 0527-99-100	 <b>41480005</b> 0527-10-271A ø97
2,5 2476	4 CYL ø91,1 PREGIO K2500 BONGO ( SOCH )	94 PS / 69 KW	4DBH	<b>41470002</b> 20910-42E00 	 <b>41470005</b> MD302893 1,60mm 5 <b>41470006</b> 22311-42525 1,55mm 4 <b>41470007</b> 22311-42855 1,50mm 3 <b>41470008</b> 22311-42515 1,45mm 2 ø92,5

▲ : İçerikte Bulunmamaktadır...

▲ : Not included in the set

▲ : Non inclus dans la pochette

00: Motor Takım Keçesiz ve Subap Lastiksiz











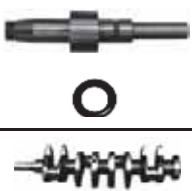













00: Gasket Set Without oil seals Without Valve Stem Seal

01: Motor Takım Keçesiz - Subap Lastikli

01: Gasket set With Valve Stem Seal Without Oil Seals

02: Motor Full Takım Keçeli ve Subap Lastikli

02: Gasket Full Set With oil seals and Valve Stem Seals

Subap Kapak Valve Cover Gasket Zylinderkopfhaube Couvre-culbut.	Karter Oil Pan Ölwanne Carter d'huile	Emme Manifold Intake Manifold Ansaug Admission	Egzoz Manifold Exhaust Manifold Auspuffkrümmer Collecteur D'echappement	Eksoz Boğaz Exhaust Pipe Auspuff Kehle	Supap Keçesi Valve Stem Seal Ventilschaft Queue de soupape	
						
						
41410025 RF01-10-235	41410013 F80110-431	41410019 RF0113-111	41410020 RF01-13-462			
						
41480025 1456-10-235	41480013 1363-89-104	41480019x4 0636-13-111	41480021x4 0750-13-461 0750-13-461A			
						
41480025 1456-10-235	41480013 1363-89-104	41480019x4 0636-13-111	41480021x4 0750-13-461 0750-13-461A			
						21201013 35x50x8 RD
41450025 MD050312	41450013 MD149392	41470021 28520-42070			41450026x8 8x13x9x13	21201023 44x60x7 RD
						21201035 80x96x9 LD
						21201004 25x35x6
						21201001 17x28x7

■ : Delik - Çentik

■ : Hole - Notch

■ : Trou - Entaille

NOT: Katalogdaki Orijinal Kodlar Referans Amacıyla Kullanılmıştır.Lütfen Oto Conta Kodlarını Kullanınız.  
Original codes used for reference only.Please use OTO CONTA codes for orders.



KIA

00



Silindir Kapak  
Cylinder Head  
Zylinderkopf  
Joint de culasse

01



02







03



04



Ltr	MODEL	PS/KW	ENGINE/MOTOR	
2,5 2497	4 CYL ø91 SORENTO CRDI 16V 08/02--> ( DOCH )	140 PS / 103 KW	D4CB	 <b>41415505</b> 22311-4A000 1,40mm FIBER / FIBRE ø92,5
2,7 2665	4 CYL ø94,5 K2700 10/97--> PREGIO BESTA GS BONGO (SOCH )	80 PS / 59 KW 82 PS / 60 KW	J2	 <b>41411205</b> OK65A10271B 1,60mm FIBER / FIBRE <b>41411206</b> OK65A10271B 2,0mm FIBER / FIBRE ø98,5
2,9 2902	4 CYL ø97,1 SEDONA 16V 10/01--> CARNIVAL TDI 16V CARNIVAL II CRDI 16V	144 PS / 106 KW	KJ	 <b>41510405</b> OK56A10271B 1,50mm FIBER / FIBRE ø100,5
2,9 2956	4 CYL ø98 BESTA GS 07/00--> K300 (SOCH )	85 PS / 63 KW	JTA	 <b>41410905</b> OK75A10271 1,60mm FIBER / FIBRE <b>41410906</b> OK75A10271 2,0mm FIBER / FIBRE ø101

▲ : İçerikte Bulunmamaktadır...

▲ : Not included in the set

▲ : Non inclus dans la pochette

00: Motor Takım Keçesiz ve Subap Lastiksiz







00: Gasket Set Without oil seals Without Valve Stem Seal

01: Motor Takım Keçesiz - Subap Lastikli

01: Gasket set With Valve Stem Seal Without Oil Seals

02: Motor Full Takım Keçeli ve Subap Lastikli

02: Gasket Full Set With oil seals and Valve Stem Seals

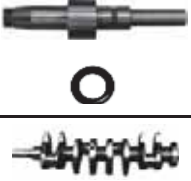
<p>Subap Kapak Valve Cover Gasket Zylinderkopfhaube Couvre-culbut.</p> 	<p>Karter Oil Pan Ölwanne Carter d'huile</p> 	<p>Emme Manifold Intake Manifold Ansaug Admission</p> 	<p>Egzoz Manifold Exhaust Manifold Auspuffkrümmer Collecteur D'echappement</p> 	<p>Eksoz Boğaz Exhaust Pipe Auspuff Kehle</p> 	<p>Supap Keçesi Valve Stem Seal Ventilschaft Queue de soupape</p> 	

■ : Delik - Çentik

■ : Hole - Notch

■ : Trou - Entaille

NOT: Katalogdaki Orijinal Kodlar Referans Amacıyla Kullanılmıştır.Lütfen Oto Conta Kodlarını Kullanınız.  
Original codes used for reference only.Please use OTO CONTA codes for orders.



KIA

00



Silindir Kapak  
Cylinder Head

01



Zylinderkopf

02







Joint de culasse

03



04



Ltr	MODEL	PS/KW	ENGINE/MOTOR	
3,3 3297	6 CYL ø92 SORENTO I V6 11/07-->	248 PS / 182 KW	G6DB	<b>41510305</b>  22311-3C140 1,50mm FIBER / FIBRE  22311-3C130 1,50mm FIBER / FIBRE <b>ø93,5</b>
3,5 3497	6 CYL ø93 SORENTO V6 11/02--> SEDONA V6 09/03--> OPIRUS V6 AMANTI V6 ( DOCH )	203 PS/ 149 KW	6G74 G6CU	<b>41416005</b>  22311-39501 1,20mm FIBER / FIBRE  22311-39502 1,20mm FIBER / FIBRE <b>ø94</b>

▲ : İçerikte Bulunmamaktadır...

▲ : Not included in the set

▲ : Non inclus dans la pochette

00: Motor Takım Keçesiz ve Subap Lastiksiz







00: Gasket Set Without oil seals Without Valve Stem Seal

01: Motor Takım Keçesiz - Subap Lastikli

01: Gasket set With Valve Stem Seal Without Oil Seals

02: Motor Full Takım Keçeli ve Subap Lastikli

02: Gasket Full Set With oil seals and Valve Stem Seals

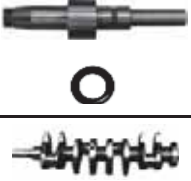
<p>Subap Kapak Valve Cover Gasket Zylinderkopfhaube Couvre-culbut.</p> 	<p>Karter Oil Pan Ölwanne Carter d'huile</p> 	<p>Emme Manifold Intake Manifold Ansaug Admission</p> 	<p>Egzoz Manifold Exhaust Manifold Auspuffkrümmer Collecteur D'echappement</p> 	<p>Eksoz Boğaz Exhaust Pipe Auspuff Kehle</p> 	<p>Supap Keçesi Valve Stem Seal Ventilschaft Queue de soupape</p> 	

■ : Delik - Çentik

■ : Hole - Notch

■ : Trou - Entaille

NOT: Katalogdaki Orijinal Kodlar Referans Amacıyla Kullanılmıştır.Lütfen Oto Conta Kodlarını Kullanınız.  
Original codes used for reference only.Please use OTO CONTA codes for orders.



LADA

00



01



02



03



04



Silindir Kapak  
Cylinder Head  
Zylinderkopf  
Joint de culasse



Ltr	MODEL	PS/KW	ENGINE/MOTOR		
1,1 1100	4 CYL ø76 FORMAN SAMARA 02/88-->12/94	53 PS / 39 KW 58 PS / 43 KW	BA3 21081	44021000 2900-4705	 44021005 2108-1003020 1,50mm ø78
1,2 1198	4 CYL ø76 VAZ 2101 VAZ 2102 01/70-->06/86	60 PS / 44 KW	BA3 2101 OHC	40311002 2101-100001  40311000 2101-100001	 40311005 2101-1003020 1,20mm  40311006 2101-1003020 1,80mm ø77,5
1,3 1288	4 CYL ø76 FORMAN SAMARA VAZ 2108 VAZ 2109 VAZ 21086 VAZ 21096 01/86-->12/94	65 PS / 48 KW 61 PS / 45 KW 63 PS / 46 KW	BA3 2108 OHC	44021000 2900-4705	 44021005 2108-1003020 1,50mm ø78
1,3 1294	4 CYL ø79 VAZ 21011 VAZ 21033 08/74-->08/84	69 PS / 51 KW	OHC	44016002 42602555  44016000 42602555	 44016005 21011-13020 1,20mm  44016006 21011-13020 1,80mm ø82
1,3 1294	4 CYL ø79 VAZ 2105 VAZ 2104 05/81-->	65 PS / 48 KW	BA3 2105	44013002 46602556  44013000 46602556	 44013005 1,20mm 2105-1003020  44013006 2105-1003020 1,80mm ø81

▲ : İçerikte Bulunmamaktadır...

▲ : Not included in the set

▲ : Non inclus dans la pochette

00: Motor Takım Keçesiz ve Subap Lastiksiz











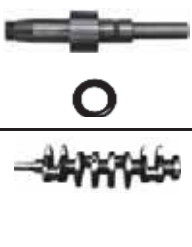















00: Gasket Set Without oil seals Without Valve Stem Seal

01: Motor Takım Keçesiz - Subap Lastikli

01: Gasket set With Valve Stem Seal Without Oil Seals

02: Motor Full Takım Keçeli ve Subap Lastikli

02: Gasket Full Set With oil seals and Valve Stem Seals

Subap Kapak Valve Cover Gasket Zylinderkopfhaube Couvre-culbut.	Karter Oil Pan Ölwanne Carter d'huile	Emme Manifold Intake Manifold Ansaug Admission	Egzoz Manifold Exhaust Manifold Auspuffkrümmer Collecteur D'echappement	Eksoz Boğaz Exhaust Pipe Auspuff Kehle	Supap Keçesi Valve Stem Seal Ventilschaft Queue de soupape	
						
<b>40345025</b> 2108-1003270	<b>40345013</b> 2108-1009070	<b>40345020x2</b> 21083-1008081		<b>40345018</b> 2101-1203020		
						<b>21201017</b> 40x56x7 LD
<b>40311034</b> 2101-1003270	<b>40311013</b> 2101-1009070	<b>40311020x2</b> 2101-1008081		<b>40345018</b> 2101-1203020	<b>40107027x8</b> 2101-1007026 8x10,8/14,2x10	<b>21201066</b> 70x90x10 RD
						
<b>40345025</b> 2108-1003270	<b>40345013</b> 2108-1009070	<b>40345020x2</b> 21083-1008081		<b>40345018</b> 2101-1203020		
						<b>21201017</b> 40x56x7 LD
<b>40311034</b> 2101-1003270	<b>40311013</b> 2101-1009070	<b>40311020x2</b> 2101-1008081		<b>40345018</b> 2101-1203020	<b>40107027x8</b> 2101-1007026 8x10,8/14,2x10	<b>21201066</b> 70x90x10 RD
						<b>21201017</b> 40x56x7 LD
<b>44013025</b> 2105-1003270	<b>44013013</b> 2105-1009070	<b>40311020x2</b> 2101-1008081		<b>40345018</b> 2101-1203020	<b>40107027x8</b> 2101-1007026 8x10,8/14,2x10	<b>21201066</b> 70x90x10 RD

■ : Delik - Çentik

■ : Hole - Notch

■ : Trou - Entaille

NOT: Katalogdaki Orijinal Kodlar Referans Amacıyla Kullanılmıştır. Lütfen Oto Conta Kodlarını Kullanınız.  
Original codes used for reference only. Please use OTO CONTA codes for orders.



LADA

00



Silindir Kapak  
Cylinder Head  
Zylinderkopf  
Joint de culasse

01



02



03



04



Ltr	MODEL	PS/KW	ENGINE/MOTOR		
1,5 1452	4 CYL ø76 VAZ 2103 11/75-->10/86 VAZ 2107 NIVA 2903	75 PS / 55 KW	OHC	40311002 2101-100001  40311000 2101-100001	 40311005 2101-1003020 1,20mm  40311006 2101-1003020 1,80mm ø77,5
1,5 1452	4 CYL ø79 VAZ 2107 1976-->	75 PS / 55 KW	OHC	44016002 42602555  44016000 42602555	 44016005 21011-13020 1,20mm  44016006 21011-13020 1,80mm ø82
1,5 1499	4 CYL ø82 SAMARA 01/88--> FORMAN VAZ 21083 VAZ 21093 ALEKO SAGONA	75 PS / 55 KW 78 PS / 57 KW 72 PS / 53 KW 71 PS / 52 KW	OHC BA 21083 BA 21093	40345002 2900-4706  40345000 2900-4706	 40345005 21083-1003020 1,50mm  ø84
1,5 1499	4 CYL ø82 110 16 V 01/95--> 111 16 V 10/00--> 112 16 V ( DOCH )	95 PS / 70 KW 91 PS / 67 KW	VAZ 2112	44101000	 44101005 21120-100302000 1,50mm  ø83

▲ : İçerikte Bulunmamaktadır...

▲ : Not included in the set

▲ : Non inclus dans la pochette

00: Motor Takım Keçesiz ve Subap Lastiksiz



















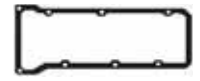



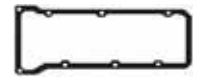

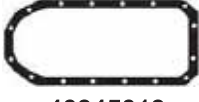

00: Gasket Set Without oil seals Without Valve Stem Seal

01: Motor Takım Keçesiz - Subap Lastikli

01: Gasket set With Valve Stem Seal Without Oil Seals

02: Motor Full Takım Keçeli ve Subap Lastikli

02: Gasket Full Set With oil seals and Valve Stem Seals

Subap Kapak Valve Cover Gasket Zylinderkopfhaube Couvre-culbut.	Karter Oil Pan Ölwanne Carter d'huile	Emme Manifold Intake Manifold Ansaug Admission	Egzoz Manifold Exhaust Manifold Auspuffkrümmer Collecteur D'echappement	Eksoz Boğaz Exhaust Pipe Auspuff Kehle	Supap Keçesi Valve Stem Seal Ventilschaft Queue de soupape	
						
 <b>40311034</b> 2101-1003270	 <b>40311013</b> 2101-1009070	 <b>40311020x2</b> 2101-1008081		 <b>40345018</b> 2101-1203020	 <b>40107027x8</b> 2101-1007026 8x10,8/14,2x10	<b>21201017</b> 40x56x7 LD
						<b>21201066</b> 70x90x10 RD
 <b>40311034</b> 2101-1003270	 <b>40311013</b> 2101-1009070	 <b>40311020x2</b> 2101-1008081		 <b>40345018</b> 2101-1203020	 <b>40107027x8</b> 2101-1007026 8x10,8/14,2x10	<b>21201017</b> 40x56x7 LD
						<b>21201066</b> 70x90x10 RD
 <b>40345025</b> 2108-1003270	 <b>40345013</b> 2108-1009070	 <b>40345020</b> 21083-1008081		 <b>40345018</b> 2101-1203020	 <b>40107027x8</b> 2101-1007026 8x10,8/14,2x10	<b>21201103x2</b> 28x42x7 RD
						<b>21201071</b> 80x100x10 LD
	 <b>40345013</b> 2108-1009070	 <b>44016018</b>	 <b>44016020</b> 21120-100808900	 <b>44016017</b>		

■ : Delik - Çentik

■ : Hole - Notch

■ : Trou - Entaille

NOT: Katalogdaki Orijinal Kodlar Referans Amacıyla Kullanılmıştır.Lütfen Oto Conta Kodlarını Kullanınız.  
Original codes used for reference only.Please use OTO CONTA codes for orders.



LADA

00



Silindir Kapak  
Cylinder Head

01



Zylinderkopf

02



Joint de culasse

03



04



Ltr	MODEL	PS/KW	ENGINE/MOTOR		
1,6 1568	4 CYL ø79 VAZ 2107 NIVA 2121 ALEKO	04/80-->03/95 76 PS / 56 KW 73 PS / 54 KW	BA3	44016002 42602555  44016000 42602555	  44016005 21011-13020 1,20mm  44016006 21011-13020 1,80mm ø82
1,9 1905	4 CYL ø83 NIVA 2121 ALEKO	1990--> 65 PS / 47 KW	XUD9(D9A) XUD9	41204002 0197.H5   41204003 0197.H4 	 41204009 0209.S5 1,36 mm 1 41204008 0209.S6 1,40 mm 2 41204007 0209.S7 1,44 mm 3 41204006 0209.S8 1,48 mm 4 41204005 0209.S9 1,53 mm 5 ø 84

▲ : İçerikte Bulunmamaktadır...

▲ : Not included in the set

▲ : Non inclus dans la pochette

00: Motor Takım Keçesiz ve Subap Lastiksiz



















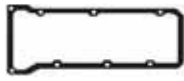



00: Gasket Set Without oil seals Without Valve Stem Seal

01: Motor Takım Keçesiz - Subap Lastikli

01: Gasket set With Valve Stem Seal Without Oil Seals

02: Motor Full Takım Keçeli ve Subap Lastikli

02: Gasket Full Set With oil seals and Valve Stem Seals

Subap Kapak Valve Cover Gasket Zylinderkopfhaube Couvre-culbut.	Karter Oil Pan Ölwanne Carter d'huile	Emme Manifold Intake Manifold Ansaug Admission	Egzoz Manifold Exhaust Manifold Auspuffkrümmer Collecteur D'echappement	Eksoz Boğaz Exhaust Pipe Auspuff Kehle	Supap Keçesi Valve Stem Seal Ventilschaft Queue de soupape	
						
 <b>40311034</b> 2101-1003270	 <b>40311013</b> 2101-1009070	 <b>40311020x2</b> 2101-1008081		 <b>40345018</b> 2101-1203020	 <b>40107027x8</b> 2101-1007026 8x10,8/14,2x10	<b>21201017</b> 40x56x7 LD
 <b>41203525</b> 0249.46 0249.91	 <b>41203013</b> 0304.34  <b>41203014</b> 93501565	 <b>41203116x2</b> 9456044080  <b>41203018x2</b> 91508659	 <b>41205019</b> 1721.01 7810024000  <b>41203120x2</b> 0349.47 93010402  <b>41203021</b> 0348.JO		 <b>40107027x8</b> 2101-1007026 8x10,8/14,2x10	<b>21201011x2</b> 35x50x8 WD
						<b>21201019</b> 42x62x8 RD <b>21201040</b> 90x110x7 LD

■ : Delik - Çentik

■ : Hole - Notch

■ : Trou - Entaille

NOT: Katalogdaki Orijinal Kodlar Referans Amacıyla Kullanılmıştır.Lütfen Oto Conta Kodlarını Kullanınız.  
Original codes used for reference only.Please use OTO CONTA codes for orders.



## LAND ROVER

00



Silindir Kapak  
Cylinder Head

01



Zylinderkopf

02



Joint de culasse

03



04



Ltr	MODEL	PS/KW	ENGINE/MOTOR	
2,3 2286	4 CYL ø90,5 88 09/63-->12/86 90 109 110	69 PS / 51 KW	23L	 <b>41415105</b> 277819 1,20mm  <b>41415106</b> 277819 1,80mm  ø96
2,5 2495	4 CYL ø90,5 90 09/85-->07/90 110 DEFENDER	84 PS / 62 KW	17H	 <b>41415105</b> 277819 1,20mm  <b>41415106</b> 277819 1,80mm  ø96

▲ : İçerikte Bulunmamaktadır...

▲ : Not included in the set

▲ : Non inclus dans la pochette

00: Motor Takım Keçesiz ve Subap Lastiksiz







00: Gasket Set Without oil seals Without Valve Stem Seal

01: Motor Takım Keçesiz - Subap Lastikli

01: Gasket set With Valve Stem Seal Without Oil Seals

02: Motor Full Takım Keçeli ve Subap Lastikli

02: Gasket Full Set With oil seals and Valve Stem Seals

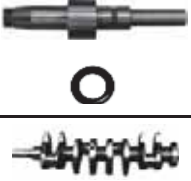
<p>Subap Kapak Valve Cover Gasket Zylinderkopfhaube Couvre-culbut.</p> 	<p>Karter Oil Pan Ölwanne Carter d'huile</p> 	<p>Emme Manifold Intake Manifold Ansaug Admission</p> 	<p>Egzoz Manifold Exhaust Manifold Auspuffkrümmer Collecteur D'echappement</p> 	<p>Eksoz Boğaz Exhaust Pipe Auspuff Kehle</p> 	<p>Supap Keçesi Valve Stem Seal Ventilschaft Queue de soupape</p> 	

■ : Delik - Çentik

■ : Hole - Notch

■ : Trou - Entaille

NOT: Katalogdaki Orijinal Kodlar Referans Amacıyla Kullanılmıştır.Lütfen Oto Conta Kodlarını Kullanınız.  
Original codes used for reference only.Please use OTO CONTA codes for orders.



MAHINDRA

00



01



02



03



04



Silindir Kapak  
Cylinder Head  
Zylinderkopf  
Joint de culasse



Ltr	MODEL	PS/KW	ENGINE/MOTOR		
2,1 2112	4 CYL ø90 CLASSIC NC 540 DP NC 649 DP NM 550 DP NM 550 XD NM 750 ST NM 775	62 PS / 45 KW	XDP4.90	41212002 0198.40	 41212005 0203.70 1,60mm 41212006 79 32 566 274 1,80mm ø94
2,5 2498	4 CYL ø94 BOLERO DELIVERY VAN SINGLE CAB DOUBLE CAB NM 540 XDB NM 550 XDB NM 775 RAKSHAK VOYAGER	72 PS / 53 KW 75 PS / 55 KW	XD3P	41218000 0198.94 	 41218005 6 812 074 1,73mm 4 41218006 6 812 073 1,63mm 3 41218007 6 812 072 1,53mm 2 ø96

▲ : İçerikte Bulunmamaktadır...

▲ : Not included in the set

▲ : Non inclus dans la pochette

00: Motor Takım Keçesiz ve Subap Lastiksiz











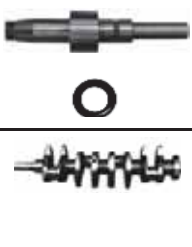











00: Gasket Set Without oil seals Without Valve Stem Seal

01: Motor Takım Keçesiz - Subap Lastikli

01: Gasket set With Valve Stem Seal Without Oil Seals

02: Motor Full Takım Keçeli ve Subap Lastikli

02: Gasket Full Set With oil seals and Valve Stem Seals

Subap Kapak Valve Cover Gasket Zylinderkopfhaube Couvre-culbut.	Karter Oil Pan Ölwanne Carter d'huile	Emme Manifold Intake Manifold Ansaug Admission	Egzoz Manifold Exhaust Manifold Auspuffkrümmer Collecteur D'echappement	Eksoz Boğaz Exhaust Pipe Auspuff Kehle	Supap Keçesi Valve Stem Seal Ventilschaft Queue de soupape	
						
 <b>41212525</b> 1 651 701	 <b>41212014</b> 0313.19  <b>41212015</b> 0304.12	 <b>41212016x3</b> 0348.11	 <b>41212020x2</b> 1 576 449	 <b>41205018</b> 1710.07  <b>41212018</b> 1710.15  <b>41212019</b> 1710.19		<b>21201020</b> 42x60x10 RD
 <b>41212525</b> 1 651 701	 <b>41212014</b> 6 894 122  <b>41212015</b> 0304.12	 <b>41212016x3</b> 0348.11	 <b>41212020x2</b> 0349.10	 <b>41212018</b> 1710.15  <b>41212019</b> 1710.19		

 : Delik - Çentik

 : Hole - Notch

 : Trou - Entaille

NOT: Katalogdaki Orijinal Kodlar Referans Amacıyla Kullanılmıştır.Lütfen Oto Conta Kodlarını Kullanınız.  
Original codes used for reference only.Please use OTO CONTA codes for orders.



MAZDA

00



01



02



03



04



Silindir Kapak  
Cylinder Head  
Zylinderkopf  
Joint de culasse



Ltr	MODEL	PS/KW	ENGINE/MOTOR		
1,3 1290	4 CYL ø77 323 08/85-->04/90	60 PS / 44 KW	E3		 <b>41480305</b> E301-10-271 1,40mm <b>41480306</b> E301-10-271 2,00mm ø78,5
1,3 1323	4 CYL ø71 FAMILIA 121 323 09/87-->11/90	60 PS / 44 KW 55 PS / 40 KW	B3		 <b>41410605</b> B302-10-271 1,60mm <b>41410606</b> B302-10-271 2,00mm ø74
1,4 1399	4 CYL ø74 MAZDA 2 04/03-->06/08	68 PS / 50 KW	MZR-CD F6JA F6JB	<b>41706002</b> Motor Full Takım Gasket Full Set  <b>41706003</b> Motor Üst Takım Gasket Head Set  <b>41706004</b> Motor Alt Takım Conversion Set	 <b>41706005</b> Y401-10-2H1 1,45mm 5 <b>41706006</b> Y401-10-274 1,40mm 4 <b>41706007</b> Y401-10-272 1,30mm 3 <b>41706008</b> Y401-10-271 1,25mm 2 <b>41706009</b> Y401-10-273 1,35mm 1 MLS ø75

▲ : İçerikte Bulunmamaktadır...

▲ : Not included in the set

▲ : Non inclus dans la pochette

00: Motor Takım Keçesiz ve Subap Lastiksiz











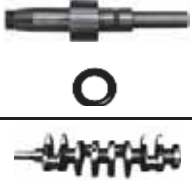

00: Gasket Set Without oil seals Without Valve Stem Seal

01: Motor Takım Keçesiz - Subap Lastikli

01: Gasket set With Valve Stem Seal Without Oil Seals

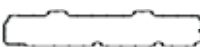
02: Motor Full Takım Keçeli ve Subap Lastikli

02: Gasket Full Set With oil seals and Valve Stem Seals

Subap Kapak Valve Cover Gasket Zylinderkopfhaube Couvre-culbut.	Karter Oil Pan Ölwanne Carter d'huile	Emme Manifold Intake Manifold Ansaug Admission	Egzoz Manifold Exhaust Manifold Auspuffkrümmer Collecteur D'echappement	Eksoz Boğaz Exhaust Pipe Auspuff Kehle	Supap Keçesi Valve Stem Seal Ventilschaft Queue de soupape	
						
						<b>21204017</b> 27x47x7 RD
<b>41706025</b> Y401-10-235	<b>42427465</b>	<b>41706019x4</b> Y401-13-113	<b>41706021</b> Y401-13-460		<b>41706027x8</b> Y401-10-155 5,5x9,5x22,9x17,5	<b>21204018</b> 40x55x6,4 LD
						<b>21204019</b> 85x105x8,8 RD

■ : Delik - Çentik

■ : Hole - Notch

■ : Trou - Entaille

NOT: Katalogdaki Orijinal Kodlar Referans Amacıyla Kullanılmıştır.Lütfen Oto Conta Kodlarını Kullanınız.  
Original codes used for reference only.Please use OTO CONTA codes for orders.



MAZDA

00



Silindir Kapak

Cylinder Head

01



Zylinderkopf

02



Joint de culasse

03



04



Ltr	MODEL	PS/KW	ENGINE/MOTOR		
1,5 1490	4 CYL ø77 323 GLC FAMILIA FAMILIA TURBO 323 TURBO 05/85-->05/89	75 PS / 55 KW 88 PS / 65 KW 95 PS / 70 KW 115 PS / 85 KW	E5 E5T		 <b>41480305</b> E301-10-271 1,40mm <b>41480306</b> E301-10-271 2,00mm ø78,5
1,5 1490	4 CYL ø78 818 1972-->1977	100 PS / 73 KW	NA	<b>41420002</b> 8051-99-100	 <b>41420005</b> R201-10-271F 1,50mm <b>41420006</b> R201-10-271F 2,00mm ø80

▲ : İçerikte Bulunmamaktadır...

▲ : Not included in the set

▲ : Non inclus dans la pochette

00: Motor Takım Keçesiz ve Subap Lastiksiz













00: Gasket Set Without oil seals Without Valve Stem Seal

01: Motor Takım Keçesiz - Subap Lastikli

01: Gasket set With Valve Stem Seal Without Oil Seals

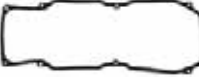
02: Motor Full Takım Keçeli ve Subap Lastikli

02: Gasket Full Set With oil seals and Valve Stem Seals

Subap Kapak Valve Cover Gasket Zylinderkopfhaube Couverculbut.	Karter Oil Pan Ölwanne Carter d'huile	Emme Manifold Intake Manifold Ansaug Admission	Egzoz Manifold Exhaust Manifold Auspuffkrümmer Collecteur D'echappement	Eksoz Boğaz Exhaust Pipe Auspuff Kehle	Supap Keçesi Valve Stem Seal Ventilschaft Queue de soupape	  
						
 <b>41420034</b> 022110235A	 <b>41420013</b> 0221-10-431	 <b>41420019</b> 038113111A	 <b>41420020</b> 0221-13-462	 <b>41420017</b> 802B-13-483		<b>21201026</b> 48x70x12 RD <b>21201205</b> 80x105x13 LD

■ : Delik - Çentik

■ : Hole - Notch

■ : Trou - Entaille

NOT: Katalogdaki Orijinal Kodlar Referans Amacıyla Kullanılmıştır.Lütfen Oto Conta Kodlarını Kullanınız.  
 Original codes used for reference only.Please use OTO CONTA codes for orders.



MAZDA

00



01



02



03



04



Silindir Kapak  
Cylinder Head  
Zylinderkopf  
Joint de culasse



Ltr	MODEL	PS/KW	ENGINE/MOTOR		
1,5 1498	4 CYL ø78 323 16 V ( DOCH ) 09/98-->01/01	88 PS / 65 KW	ZL		 <b>41420205</b> ZL01-10-271A 1,20mm FIBER / FIBRE  <b>41420206</b> ZL01-10-271A 2,00mm FIBER /FIBRE <b>ø79,5</b>
1,5 1498	4 CYL ø78 MAZDA 2 16V ( DOCH ) 10/07-->	103 PS / 76 KW	ZY-DE ZY-VE		 <b>41420105</b> ZY01-10-271A 1,20mm FIBER / FIBRE <b>ø79,5</b>
1,6 1560	4 CYL ø75 MAZDA 3 16V ( DOCH ) 06/04-->06/09	109 PS / 80 KW	Y601	<b>41707002</b> Motor Full Takım Gasket Full Set  <b>41707003</b> Motor Üst Takım Gasket Head Set  <b>41706004</b> Motor Alt Takım Conversion Set	 <b>41707005</b> Y601-10-2H1 1,45mm 5 <b>41707006</b> Y601-10-274 1,40mm 4 <b>41707007</b> Y601-10-272 1,30mm 3 <b>41707008</b> Y601-10-271 1,25mm 2 <b>41707009</b> Y601-10-273 1,35mm 1 MLS <b>ø76</b>

▲ : İçerikte Bulunmamaktadır...

▲ : Not included in the set

▲ : Non inclus dans la pochette

00: Motor Takım Keçesiz ve Subap Lastiksiz











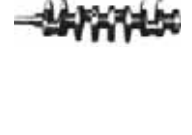

00: Gasket Set Without oil seals Without Valve Stem Seal

01: Motor Takım Keçesiz - Subap Lastikli

01: Gasket set With Valve Stem Seal Without Oil Seals

02: Motor Full Takım Keçeli ve Subap Lastikli

02: Gasket Full Set With oil seals and Valve Stem Seals

Subap Kapak Valve Cover Gasket Zylinderkopfhaube Couvre-culbut.	Karter Oil Pan Ölwanne Carter d'huile	Emme Manifold Intake Manifold Ansaug Admission	Egzoz Manifold Exhaust Manifold Auspuffkrümmer Collecteur D'echappement	Eksoz Boğaz Exhaust Pipe Auspuff Kehle	Supap Keçesi Valve Stem Seal Ventilschaft Queue de soupape	 
						
 <b>41707025</b> Y601-10-235	 <b>42427465</b>	 Y601-10-238 x4  Y601-13-113 x4 <b>41707018</b>	 <b>41706021</b> Y401-13-460		 <b>41707026x16</b> Y601-10-155 <b>5,5x9,5x18,1x14</b>	<b>21204017</b> 27x47x7 RD <b>21204018</b> 40x55x6,4 LD <b>21204019</b> 85x105x8,8 RD

■ : Delik - Çentik

■ : Hole - Notch

■ : Trou - Entaille

NOT: Katalogdaki Orijinal Kodlar Referans Amacıyla Kullanılmıştır.Lütfen Oto Conta Kodlarını Kullanınız.  
Original codes used for reference only.Please use OTO CONTA codes for orders.



# MAZDA

00

Silindir Kapak  
Cylinder Head

01



Zylinderkopf

02



Joint de culasse

03



04



Ltr	MODEL	PS/KW	ENGINE/MOTOR		
1,6 1586	4 CYL ø78 616 1970->1978 626 1979->1982 818 1971->1978 B 1600 1971->1975 CAPELLA 1971->1975 PICK-UP 1971->1975	75 PS / 55 KW	NA	41420002 8051-99-100	 41420005 R201-10-271F 1,50mm 41420006 R201-10-271F 2,00mm ø80
1,6 1587	4 CYL ø81 CAPELLA 11/82-->09/87 626 ( SOCH )	80 PS / 59 KW	F6		 41420505 F501-10-F271 1,80mm ø83,5
1,6 1596	4 CYL ø79 MAZDA 2 16V 10/03--> ( DOCH )	101 PS 74 KW	C6 FYJA		 42218205 1 305 949 1,20mm FIBER / FIBRE ø80
1,6 1597	4 CYL ø78 PROTEGE 16V 01/01-->05/04 323 ( DOCH )	98 PS / 72 KW 95 PS / 70 KW	ZM		 41420205 ZL01-10-271A 1,20mm FIBER / FIBRE 41420206 ZL01-10-271A 2,00mm FIBER / FIBRE ø79,5
1,6 1598	4 CYL ø78 MAZDA 3 16V 10/03--> ( DOCH )	105 PS / 77 KW	Z6 B6ZE LF		 41420105 ZY01-10-271A 1,20mm FIBER / FIBRE ø79,5

▲ : İçerikte Bulunmamaktadır...

▲ : Not included in the set

▲ : Non inclus dans la pochette

00: Motor Takım Keçesiz ve Subap Lastiksiz











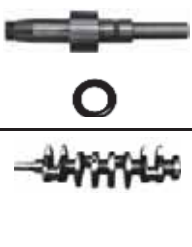

00: Gasket Set Without oil seals Without Valve Stem Seal

01: Motor Takım Keçesiz - Subap Lastikli

01: Gasket set With Valve Stem Seal Without Oil Seals

02: Motor Full Takım Keçeli ve Subap Lastikli

02: Gasket Full Set With oil seals and Valve Stem Seals

Subap Kapak Valve Cover Gasket Zylinderkopfhaube Couvre-culbut.	Karter Oil Pan Ölwanne Carter d'huile	Emme Manifold Intake Manifold Ansaug Admission	Egzoz Manifold Exhaust Manifold Auspuffkrümmer Collecteur D'echappement	Eksoz Boğaz Exhaust Pipe Auspuff Kehle	Supap Keçesi Valve Stem Seal Ventilschaft Queue de soupape	
						
 41420034 022110235A	 41420013 0221-10-431	 41420019 038113111A	 41420020 0221-13-462	 41420017 802B-13-483		21201026 48x70x12 RD
						21201205 80x105x13 LD

■ : Delik - Çentik

■ : Hole - Notch

■ : Trou - Entaille

NOT: Katalogdaki Orijinal Kodlar Referans Amacıyla Kullanılmıştır.Lütfen Oto Conta Kodlarını Kullanınız.  
Original codes used for reference only.Please use OTO CONTA codes for orders.



MAZDA

00



Silindir Kapak  
Cylinder Head  
Zylinderkopf  
Joint de culasse

01



02



03



04



Ltr	MODEL	PS/KW	ENGINE/MOTOR		
1,6 1598	4 CYL ø78 323 ( SOCH ) 09/89-->10/94	84 PS / 62 KW 88 PS / 65 KW	B6		 <b>41480205</b> 0B61L10271A 1,30mm ø79,5
1,8 1789	4 CYL ø86 CAPELLA 626 929 ( SOCH ) 08/87-->	90 PS / 66 KW	F8		 <b>41420305</b> F202-10-271 1,40mm <b>41420306</b> F202-10-271 1,80mm ø87,5
2,0 1998	4 CYL ø86 626 12V 929 12V CAPELLA E 2000 ( SOCH ) 03/83-->05/03	120 PS / 88 KW 82 PS / 60 KW	FE FA FEV4 FE18 FE58 FE60 FE61		 <b>41420305</b> F202-10-271 1,40mm <b>41420306</b> F202-10-271 1,80mm ø87,5
2,0 1998	4 CYL ø86 626 16V CAPELLA 16V ( DOCH ) 06/87-->05/92	148 PS / 109 KW 140 PS / 103 KW	FE		 <b>41410305</b> OK013 10 271 1,20mm FIBER / FIBRE ø87,5
2,0 1998	4 CYL ø86 E 2000 626 CAPELLA 10/92-->04/97 01/83-->02/88	75 PS / 55 KW 63 PS / 46 KW	RF	<b>41410000</b> RF01-99-100	 <b>41410005</b> R201-10-271A ø87,5
2,0 1999	4 CYL ø87,5 MAZDA 6 16V MAZDA 3 16V ( DOCH ) 06/02-->02/05	141 PS / 104 KW 150 PS / 110 KW	LF17 LF18		 <b>41420405</b> 1 229 872 1,20mm FIBER / FIBRE ø89

▲ : İçerikte Bulunmamaktadır...

▲ : Not included in the set

▲ : Non inclus dans la pochette

00: Motor Takım Keçesiz ve Subap Lastiksiz











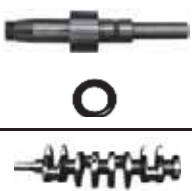

00: Gasket Set Without oil seals Without Valve Stem Seal

01: Motor Takım Keçesiz - Subap Lastikli

01: Gasket set With Valve Stem Seal Without Oil Seals

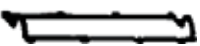
02: Motor Full Takım Keçeli ve Subap Lastikli

02: Gasket Full Set With oil seals and Valve Stem Seals

Subap Kapak Valve Cover Gasket Zylinderkopfhaube Couvre-culbut.	Karter Oil Pan Ölwanne Carter d'huile	Emme Manifold Intake Manifold Ansaug Admission	Egzoz Manifold Exhaust Manifold Auspuffkrümmer Collecteur D'echappement	Eksoz Boğaz Exhaust Pipe Auspuff Kehle	Supap Keçesi Valve Stem Seal Ventilschaft Queue de soupape	
						
						
41410025 RF01-10-235	41410013 F80110-431	41410019 RF0113-111	41410020 RF01-13-462			

■ : Delik - Çentik

■ : Hole - Notch

■ : Trou - Entaille

NOT: Katalogdaki Orijinal Kodlar Referans Amacıyla Kullanılmıştır.Lütfen Oto Conta Kodlarını Kullanınız.  
Original codes used for reference only.Please use OTO CONTA codes for orders.



# MAZDA

00



01



02



03



04



Silindir Kapak  
Cylinder Head  
Zylinderkopf  
Joint de culasse



Ltr	MODEL	PS/KW	ENGINE/MOTOR		
2,2 2184	4 CYL ø86 929 11/87-->11/96 B 2200 626 TURBO 12V MX-6 TURBO 12V BT-50  929 12V 626 12V ( SOCH )	115 PS / 85 KW	F2 F2L		 <b>41420305</b> F202-10-271 1,40mm  <b>41420306</b> F202-10-271 1,80mm ø87,5
2,2 2184	4 CYL ø86 E 2200 01/84-->05/03 B 2200	71 PS / 52 KW 63 PS / 46 KW	R2 R203 R207 R281 R290	<b>41410000</b> RF01-99-100	 <b>41410005</b> R201-10-271A FIBER / FIBRE ø87,5
2,2 2209	4 CYL ø89 B 2200 1979-->1981 LUCE	63 PS / 46 KW	S2		 <b>41480005</b> 0527-10-271A ø97
2,2 2261	4 CYL ø87,5 MAZDA 6 16V 07/02-->08/07 MPV 16V TRIBUTE 16V ( DOCH )	150 PS / 110 KW 141 PS / 104 KW 166 PS / 122 KW 162 PS / 119 KW	L3		 <b>41420405</b> 1 229 872 1,20mm FIBER / FIBRE  ø89
2,5 2522	4 CYL ø89 E 2500 1973-->1977	81 PS / 77 KW	XA	<b>41480000</b> 0527-99-100	 <b>41480005</b> 0527-10-271A ø97
2,7 2701	4 CYL ø89 E 2700 1973-->1977	81 PS / 77 KW	XB	<b>41480000</b> 0527-99-100	 <b>41480005</b> 0527-10-271A ø97

▲ : İçerikte Bulunmamaktadır...

▲ : Not included in the set

▲ : Non inclus dans la pochette

00: Motor Takım Keçesiz ve Subap Lastiksiz











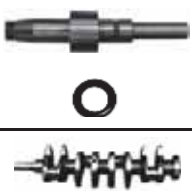









00: Gasket Set Without oil seals Without Valve Stem Seal

01: Motor Takım Keçesiz - Subap Lastikli

01: Gasket set With Valve Stem Seal Without Oil Seals

02: Motor Full Takım Keçeli ve Subap Lastikli

02: Gasket Full Set With oil seals and Valve Stem Seals

Subap Kapak Valve Cover Gasket Zylinderkopfhaube Couvre-culbut.	Karter Oil Pan Ölwanne Carter d'huile	Emme Manifold Intake Manifold Ansaug Admission	Egzoz Manifold Exhaust Manifold Auspuffkrümmer Collecteur D'echappement	Eksoz Boğaz Exhaust Pipe Auspuff Kehle	Supap Keçesi Valve Stem Seal Ventilschaft Queue de soupape	
						
						
41410025 RF01-10-235	41410013 F80110-431	41410019 RF0113-111	41410020 RF01-13-462			
						
41480025 1456-10-235	41480013 1363-89-104	41480019x4 0636-13-111	41480021x4 0750-13-461 0750-13-461A			
						
41480025 1456-10-235	41480013 1363-89-104	41480019x4 0636-13-111	41480021x4 0750-13-461 0750-13-461A			

■ : Delik - Çentik

■ : Hole - Notch

■ : Trou - Entaille

NOT: Katalogdaki Orijinal Kodlar Referans Amacıyla Kullanılmıştır.Lütfen Oto Conta Kodlarını Kullanınız.  
Original codes used for reference only.Please use OTO CONTA codes for orders.



MITSUBISHI

00



Silindir Kapak  
Cylinder Head

01



Zylinderkopf

02



Joint de culasse

03



04



Ltr	MODEL	PS/KW	ENGINE/MOTOR		
1,3 1298	4 CYL ø71 COLT 06/86-->05/92 LANCER MIRAGE PROTON SAGA ( SOHC )	70 PS / 51 KW 60 PS / 44 KW	G13B 4G13 4G13B		 <b>41507005</b> MD066163 1,40mm ø72,5
1,3 1298	4 CYL ø71 COLT 12V 07/90-->05/94 LANCER 12V MIRAGE 12V LIBERO 12V LIBERO CARGO 12V PROTON PERSONA 12V ( SOHC )	75 PS / 55 KW 60 PS / 44 KW	4G13		 <b>41415405</b> MD323473 1,40mm ø76,5
1,5 1468	4 CYL ø75,5 COLT 11/83-->08/89 LANCER ( SOHC ) MIRAGE PRECIS PROTON SAGA	75 PS / 55 KW 70 PS / 50 KW 84 PS / 62 KW	4G15 G15B		 <b>41500305</b> MD016163 1,40mm  <b>41500306</b> MD016163 2,00mm ø76,5
1,5 1468	4 CYL ø75,5 COLT 12V 05/89-->08/99 LANCER 12V MIRAGE 12V LIBERO 12V LIBERO CARGO 12V PROTON SAGA 12V PROTON PERSONA 12V ( SOHC )	110 PS / 81 KW 86 PS / 63 KW 90 PS / 66 KW	4G15		 <b>41415405</b> MD323473 1,40mm ø76,5
1,6 1584	4 CYL ø76 LANCER 09/03--> SPACE STAR 01/01-->12/04	98 PS / 72 KW	4G18		 <b>41415305</b> MD342397 1,80mm  <b>41415306</b> MD342397 2,00mm FIBER / FIBRE ø77

▲ : İçerikte Bulunmamaktadır...

▲ : Not included in the set

▲ : Non inclus dans la pochette

00: Motor Takım Keçesiz ve Subap Lastiksiz







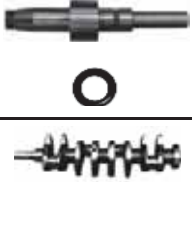

00: Gasket Set Without oil seals Without Valve Stem Seal

01: Motor Takım Keçesiz - Subap Lastikli

01: Gasket set With Valve Stem Seal Without Oil Seals

02: Motor Full Takım Keçeli ve Subap Lastikli

02: Gasket Full Set With oil seals and Valve Stem Seals

Subap Kapak Valve Cover Gasket Zylinderkopfhaube Couvre-culbut.	Karter Oil Pan Ölwanne Carter d'huile	Emme Manifold Intake Manifold Ansaug Admission	Egzoz Manifold Exhaust Manifold Auspuffkrümmer Collecteur D'echappement	Eksoz Boğaz Exhaust Pipe Auspuff Kehle	Supap Keçesi Valve Stem Seal Ventilschaft Queue de soupape	
						

■ : Delik - Çentik

■ : Hole - Notch

■ : Trou - Entaille

NOT: Katalogdaki Orijinal Kodlar Referans Amacıyla Kullanılmıştır.Lütfen Oto Conta Kodlarını Kullanınız.  
Original codes used for reference only.Please use OTO CONTA codes for orders.



MITSUBISHI

00



Silindir Kapak  
Cylinder Head

01



Zylinderkopf

02



Joint de culasse

03



04



Ltr	MODEL	PS/KW	ENGINE/MOTOR	
2,0	4 CYL ø85			
1997	ETERNA SAPPORO COLT GALANT SIGMA STARION PAJERO SPACE WAGON GALANT TURBO CORDIA PICK-UP TREDIA STARION TURBO EXPO L200 L300 NIMBUS EXPO CHARIOT GRANDIS  ( SOCH )	03/85-->04/91  90 PS / 66 KW 84 PS / 62 KW 102 PS / 75 KW	G63B G63B Turbo 4G63 G63BT	 <b>41500905</b> MD040533 1,40mm  <b>41500906</b> MD040533 2,00mm ø86

▲ : İçerikte Bulunmamaktadır...

▲ : Not included in the set

▲ : Non inclus dans la pochette

00: Motor Takım Keçesiz ve Subap Lastiksiz









00: Gasket Set Without oil seals Without Valve Stem Seal

01: Motor Takım Keçesiz - Subap Lastikli

01: Gasket set With Valve Stem Seal Without Oil Seals

02: Motor Full Takım Keçeli ve Subap Lastikli

02: Gasket Full Set With oil seals and Valve Stem Seals

<p>Subap Kapak Valve Cover Gasket Zylinderkopfhaube Couvre-culbut.</p> 	<p>Karter Oil Pan Ölwanne Carter d'huile</p> 	<p>Emme Manifold Intake Manifold Ansaug Admission</p> 	<p>Egzoz Manifold Exhaust Manifold Auspuffkrümmer Collecteur D'echappement</p> 	<p>Eksoz Boğaz Exhaust Pipe Auspuff Kehle</p> 	<p>Supap Keçesi Valve Stem Seal Ventilschaft Queue de soupape</p> 	  

■ : Delik - Çentik

■ : Hole - Notch

■ : Trou - Entaille

NOT: Katalogdaki Orijinal Kodlar Referans Amacıyla Kullanılmıştır.Lütfen Oto Conta Kodlarını Kullanınız.  
Original codes used for reference only.Please use OTO CONTA codes for orders.



MITSUBISHI

00



01



02



03











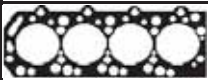



04

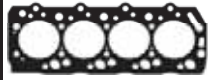

Silindir Kapak  
Cylinder Head  
Zylinderkopf  
Joint de culasse



Ltr	MODEL	PS/KW	ENGINE/MOTOR		
2,3 2346	4 CYL ø91 L200 D 04/83-->10/86 L300D CANTER D MONTERO D PAJERO D SIGMA D SPX D ( SOCH )	68 PS / 50 KW	4D55 4D55T	41450001 MD050092  41450002 MD050092	 41450005 MD050545 1,80mm ø92,5
2,5 2476	4 CYL ø91 L200D 11/86-->10/96 MONTERO D PAJERO D CANTER T35 D DELICA TD L200 TD L300 TD L400 TD SPACE GEAR TD	69 PS / 51 KW 70 PS / 51 KW 87 PS / 64 KW 95 PS / 70 KW	4D56 4D56T	41450001 MD050092 	 41470005 MD302893 1,60mm 5  41470006 22311-42525 1,55mm 4  41470007 22311-42855 1,50mm 3  41470008 22311-42515 1,45mm 2  ø92,5
2,5 2476	4 CYL ø91 L200TD 05/86--> L300D L300TD L400TD PAJERO TD SPACE GEAR TD MONTERO TURBO PAJERO TURBO	133 PS / 98 KW 84 PS / 62 KW 115 PS / 85 KW 99 PS / 73 KW	4D56T	41470002 1000A901 	 41470005 MD302893 1,60mm 5  41470006 22311-42525 1,55mm 4  41470007 22311-42855 1,50mm 3  41470008 22311-42515 1,45mm 2  ø92,5

▲ : İçerikte Bulunmamaktadır...

▲ : Not included in the set

▲ : Non inclus dans la pochette

00: Motor Takım Keçesiz ve Subap Lastiksiz











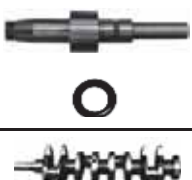





00: Gasket Set Without oil seals Without Valve Stem Seal

01: Motor Takım Keçesiz - Subap Lastikli

01: Gasket set With Valve Stem Seal Without Oil Seals

02: Motor Full Takım Keçeli ve Subap Lastikli

02: Gasket Full Set With oil seals and Valve Stem Seals

Subap Kapak Valve Cover Gasket Zylinderkopfhaube Couvre-culbut.	Karter Oil Pan Ölwanne Carter d'huile	Emme Manifold Intake Manifold Ansaug Admission	Egzoz Manifold Exhaust Manifold Auspuffkrümmer Collecteur D'echappement	Eksoz Boğaz Exhaust Pipe Auspuff Kehle	Supap Keçesi Valve Stem Seal Ventilschaft Queue de soupape	
						
41450025 MD050312	41450013 MD149392	41450021 MD050482			41450026x8 8x13x9x13	21201013 35x50x8 RD
						21201023 44x60x7 RD
						21201035 80x96x9 LD
						21201004 25x35x6
						21201001 17x28x7
						21201013 35x50x8 RD
41450025 MD050312	41450013 MD149392	41450021 MD050482			41450026x8 8x13x9x13	21201023 44x60x7 RD
						21201035 80x96x9 LD
						21201004 25x35x6
						21201001 17x28x7
						21201013 35x50x8 RD
41450025 MD050312	41450013 MD149392	41470021 28520-42070			41450026x8 8x13x9x13	21201023 44x60x7 RD
						21201035 80x96x9 LD
						21201004 25x35x6
						21201001 17x28x7

■ : Delik - Çentik

■ : Hole - Notch

■ : Trou - Entaille

NOT: Katalogdaki Orijinal Kodlar Referans Amacıyla Kullanılmıştır.Lütfen Oto Conta Kodlarını Kullanınız.  
Original codes used for reference only.Please use OTO CONTA codes for orders.



NISSAN

00



Silindir Kapak  
Cylinder Head

01



Zylinderkopf

02



Joint de culasse

03



04



Ltr	MODEL	PS/KW	ENGINE/MOTOR		
1,0 988	4 CYL ø73 SUNNY CHERRY 09/70-->09/78	45 PS / 33 KW	A10		 <b>41412005</b> 11044-H3901 1,60mm ø76
1,2 1149	4 CYL ø69 KUBISTAR 04/06-->	75 PS / 55 KW	D4F 712	<b>40108603</b> 77 01 473 003	 <b>40108605</b> 8200062273 MLS ø70
1,2 1171	4 CYL ø73 SUNNY CHERRY 07/78-->08/81	52 PS / 38 KW	A12		 <b>41412005</b> 11044-H3901 1,60mm ø76
1,3 1270	4 CYL ø76 SUNNY PULSAR LANGREY 08/81-->10/86	60 PS / 44 KW	E13S		 <b>41412105</b> 11044-01M10 1,20mm ø77,5
1,4 1397	4 CYL ø76 CHERRY SUNNY B 310 08/80-->07/81	80 PS / 59 KW	A14S		 <b>41412205</b> 11044-H7200 1,20mm ø77,5
1,4 1397	4 CYL ø73 SUNNY 06/79-->02/82	65 PS / 48 KW 67 PS / 49 KW	A14		 <b>41412005</b> 11044-H3901 1,60mm ø76

▲ : İçerikte Bulunmamaktadır...

▲ : Not included in the set

▲ : Non inclus dans la pochette

00: Motor Takım Keçesiz ve Subap Lastiksiz











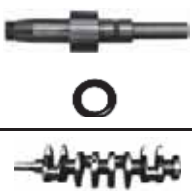

00: Gasket Set Without oil seals Without Valve Stem Seal

01: Motor Takım Keçesiz - Subap Lastikli

01: Gasket set With Valve Stem Seal Without Oil Seals

02: Motor Full Takım Keçeli ve Subap Lastikli

02: Gasket Full Set With oil seals and Valve Stem Seals

Subap Kapak Valve Cover Gasket Zylinderkopfhaube Couvre-culbut.	Karter Oil Pan Ölwanne Carter d'huile	Emme Manifold Intake Manifold Ansaug Admission	Egzoz Manifold Exhaust Manifold Auspuffkrümmer Collecteur D'echappement	Eksoz Boğaz Exhaust Pipe Auspuff Kehle	Supap Keçesi Valve Stem Seal Ventilschaft Queue de soupape	
						
						<b>21204701</b> 28x47x8 RD
<b>40108625</b> 77 01 049 888	<b>42427465</b>	<b>40108618</b> 77 01 473 007	<b>40108621</b> 77 00 115 971		<b>40108626x16</b> 5,5x11x23x15,7	

■ : Delik - Çentik

■ : Hole - Notch

■ : Trou - Entaille

NOT: Katalogdaki Orijinal Kodlar Referans Amacıyla Kullanılmıştır.Lütfen Oto Conta Kodlarını Kullanınız.  
Original codes used for reference only.Please use OTO CONTA codes for orders.



NISSAN

00



01



02



03



04



Silindir Kapak  
Cylinder Head  
Zylinderkopf  
Joint de culasse



Ltr	MODEL	PS/KW	ENGINE/MOTOR		
1,5 1461	4 CYL ø76 ALMERA DCI 01/03--> KUBISTAR DCI MICRA DCI NOTE DCI	82 PS / 60 KW 65 PS / 48 KW	K9K 700 K9K 704 K9K 722	<b>42457102</b> Motor Full Takım Gasket Full Set  <b>42457103</b> 77 01 473 371  <b>42457104</b> Motor Alt Takım Conversion Set	 <b>42457105</b> 82 00 071 111 0,60mm  <b>42457106</b> 82 00 071 111 0,82mm <b>MLS</b> <b>ø77,5</b>
1,5 1483	4 CYL ø78 PICK-UP CABSTAR HOMY TRUCK HOMER	78 PS / 57 KW	J15		 <b>41412305</b> 11044-A3800 1,80mm <b>ø80</b>
1,5 1487	4 CYL ø76 SUNNY 03/82-->08/90 PULSAR LANGREY SENTRA	75 PS / 55 KW	E15S/E		 <b>41412105</b> 11044-01M10 1,20mm <b>ø77,5</b>
1,5 1487	4 CYL ø76 VANETTE 07/81-->12/95 SUNNY B 310	82 PS / 60 KW	A15S		 <b>41412205</b> 11044-H7200 1,20mm <b>ø77,5</b>
1,5 1487	4 CYL ø76 TSURU 1984-->1994 SAMURAI SEDAN NINJA GAYIN (SOCH ) ( Mexico )	75 PS / 55 KW	E15		 <b>41412105</b> 11044-01M10 1,20mm <b>ø77,5</b>
1,5 1487	4 CYL ø76 FORKLIFT 1985-->	82 PS / 60 KW	A15		 <b>41412205</b> 11044-H7200 1,20mm <b>ø77,5</b>

▲ : İçerikte Bulunmamaktadır...

▲ : Not included in the set

▲ : Non inclus dans la pochette

00: Motor Takım Keçesiz ve Subap Lastiksiz













00: Gasket Set Without oil seals Without Valve Stem Seal

01: Motor Takım Keçesiz - Subap Lastikli

01: Gasket set With Valve Stem Seal Without Oil Seals

02: Motor Full Takım Keçeli ve Subap Lastikli

02: Gasket Full Set With oil seals and Valve Stem Seals

Subap Kapak Valve Cover Gasket Zylinderkopfhaube Couvre-culbut.	Karter Oil Pan Ölwanne Carter d'huile	Emme Manifold Intake Manifold Ansaug Admission	Egzoz Manifold Exhaust Manifold Auspuffkrümmer Collecteur D'echappement	Eksoz Boğaz Exhaust Pipe Auspuff Kehle	Supap Keçesi Valve Stem Seal Ventilschaft Queue de soupape	
						
						<b>21204024</b> 28x42x5 RD
<b>42457125</b> 13270-00Q0B	<b>42457165</b> 77 00 273 486		<b>42457121</b> 14036-BN700		<b>42457144x8</b> 77 00 109 840 6x8,8x12,2x9,7	<b>21204025</b> 35x47x7 RD
						<b>21204033</b> 80x100x9 LD

■ : Delik - Çentik

■ : Hole - Notch

■ : Trou - Entaille

NOT: Katalogdaki Orijinal Kodlar Referans Amacıyla Kullanılmıştır.Lütfen Oto Conta Kodlarını Kullanınız.  
Original codes used for reference only.Please use OTO CONTA codes for orders.



NISSAN

00



Silindir Kapak  
Cylinder Head

01



Zylinderkopf

02



Joint de culasse

03



04



Ltr	MODEL	PS/KW	ENGINE/MOTOR		
1,6 1567	4 CYL ø78 GUAYIN SEDAN PICK-UP ( Mexico ) 1970-->1985	78 PS / 57 KW	J16		 <b>41412305</b> 11044-A3800 1,80mm ø80
1,6 1567	4 CYL ø78 CABSTAR CARAVAN HOMER TRUCK 1970-->1978	80 PS / 60 KW	J16		 <b>41412305</b> 11044-A3800 1,80mm ø80
1,6 1597	4 CYL ø76 TSURU SAMURAI SEDAN NINJA GAYIN ( SOCH ) ( Mexico ) 1984-->1994	75 PS / 55 KW	E16		 <b>41412105</b> 11044-01M10 1,20mm ø77,5
1,6 1598	4 CYL ø79,5 KUBISTAR 16V 08/03-->	95 PS / 70 KW	K4M 752	<b>42457202</b> Motor Full Takım Gasket Full Set <b>42457203</b> 77 01 471 886	 <b>42457205</b> 77 00 112 739 MLS ø80,5

▲ : İçerikte Bulunmamaktadır...

▲ : Not included in the set

▲ : Non inclus dans la pochette

00: Motor Takım Keçesiz ve Subap Lastiksiz











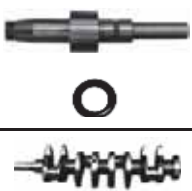

00: Gasket Set Without oil seals Without Valve Stem Seal

01: Motor Takım Keçesiz - Subap Lastikli

01: Gasket set With Valve Stem Seal Without Oil Seals

02: Motor Full Takım Keçeli ve Subap Lastikli

02: Gasket Full Set With oil seals and Valve Stem Seals

Subap Kapak Valve Cover Gasket Zylinderkopfhaube Couvre-culbut.	Karter Oil Pan Ölwanne Carter d'huile	Emme Manifold Intake Manifold Ansaug Admission	Egzoz Manifold Exhaust Manifold Auspuffkrümmer Collecteur D'echappement	Eksoz Boğaz Exhaust Pipe Auspuff Kehle	Supap Keçesi Valve Stem Seal Ventilschaft Queue de soupape	
						
						<b>21204024x2</b> 28x42x5 RD
	<b>42457265</b> 77 00 103 687	<b>42457219</b> 77 00 105 852	<b>42457221</b> 77 00 107 181		<b>42457244x16</b> 77 00 103 938 <b>5,5x11x28x16,4</b>	<b>21204005</b> 35x47x7 RD
						<b>21204009</b> 80x100x8 LD

■ : Delik - Çentik

■ : Hole - Notch

■ : Trou - Entaille

NOT: Katalogdaki Orijinal Kodlar Referans Amacıyla Kullanılmıştır.Lütfen Oto Conta Kodlarını Kullanınız.  
Original codes used for reference only.Please use OTO CONTA codes for orders.



OPEL

00



Silindir Kapak  
Cylinder Head

01



Zylinderkopf

02









Joint de culasse

03

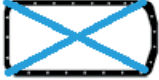

04



Ltr	MODEL	PS/KW	ENGINE/MOTOR		
1,3 1248	4 CYL ø69,6 AGILA CDTI 06/03--> COMBO TD COMBO CDTI CORSA C CDTI CORSA C DTI CORSA D CDTI MERIVA CDTI TIGRA CDTI ASTRA H CDTI 04/05--> CORSA D CDTI	75 PS / 55 KW 69 PS / 51 KW  90 PS / 66 KW	D 13 A Y 13 DT Z 13 DT Z 13 DTJ  Z 13 DTH	42427402 Motor Full Takım Gasket Full Set   42427403 16 06 458 16 06 455  42427404 16 06 456 16 06 454 	 42427505 56 07 639 0,72mm  42427506 56 07 640 0,82mm 1   42427507 56 07 641 0,92mm 2  MLS ø70,5
1,3 1297	4 CYL ø75 CORSA A 08/79-->03/93 KADETT D KADETT E ASCONA B 03/79-->08/91 ASCONA C KADETT D KADETT E MANTA B CORSA A 09/84-->08/91 KADETT E ASCONA B 03/75-->03/93 ASCONA C CORSA A KADETT D KADETT E MANTA B	60 PS / 44 KW 60 PS / 44 KW 60 PS / 44 KW 75 PS / 55 KW 57 PS / 42 KW	C 13 N  13 N  13 NB  13 S 13 SB		 42447905 607990 ø76,5

▲ : İçerikte Bulunmamaktadır...

▲ : Not included in the set

▲ : Non inclus dans la pochette

00: Motor Takım Keçesiz ve Subap Lastiksiz











00: Gasket Set Without oil seals Without Valve Stem Seal

01: Motor Takım Keçesiz - Subap Lastikli

01: Gasket set With Valve Stem Seal Without Oil Seals

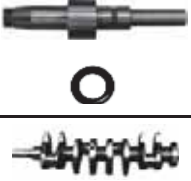
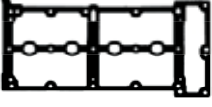
02: Motor Full Takım Keçeli ve Subap Lastikli

02: Gasket Full Set With oil seals and Valve Stem Seals

<p>Subap Kapak Valve Cover Gasket Zylinderkopfhaube Couvre-culbut.</p> 	<p>Karter Oil Pan Ölwanne Carter d'huile</p> 	<p>Emme Manifold Intake Manifold Ansaug Admission</p> 	<p>Egzoz Manifold Exhaust Manifold Auspuffkrümmer Collecteur D'echappement</p> 	<p>Eksoz Boğaz Exhaust Pipe Auspuff Kehle</p> 	<p>Supap Keçesi Valve Stem Seal Ventilschaft Queue de soupape</p> 	
 <p><b>42427425</b> 56 07 842</p>		 <p><b>42427417</b> 58 50 674</p>	 <p><b>42427421</b> 849 219</p>		 <p><b>42427426x16</b> 1 547 971 6x8,8x11,7x9,5</p>	<p><b>21204023</b> 40x52x7 RD</p> <p><b>21204034</b> 78x100x9 RD</p>

■ : Delik - Çentik

■ : Hole - Notch

■ : Trou - Entaille

NOT: Katalogdaki Orijinal Kodlar Referans Amacıyla Kullanılmıştır.Lütfen Oto Conta Kodlarını Kullanınız.  
Original codes used for reference only.Please use OTO CONTA codes for orders.



OPEL

00



01



02



03



04



Silindir Kapak  
Cylinder Head  
Zylinderkopf  
Joint de culasse



Ltr	MODEL	PS/KW	ENGINE/MOTOR		
1,4 1389	<b>4 CYL ø77,6</b> ASTRA F 09/91-->09/93 CORSA A 09/89-->03/93 KADETT E 07/89-->02/93 VECTRA A 04/88-->06/92 ASTRA F 09/91-->01/05 COMBO 07/94-->10/01 CORSA A 10/89-->03/93 CORSA B 03/93-->09/00 KADETT E 01/90-->07/94 ( OHC )	75 PS / 55 KW 54 PS / 40KW  60 PS / 44 KW	14 NV  C 14 NZ X 14 NZ X 14 SZ	<b>42447202</b> 1606697+1606728  <b>42447203</b> 1606697  <b>42447204</b> 1606728	 <b>42447205</b> 607449 1,80mm <b>ø79,5</b>
1,4 1389	<b>4 CYL ø77,6</b> ASTRA F 03/92-->03/01 COMBO 07/94-->10/01 CORSA A 09/91-->03/93 CORSA B 03/93-->09/00 KADETT E 09/89-->08/91 ( OHC )	82 PS / 90 KW	14 SE C 14 SE	<b>42447102</b> 1606730+ 1606728  <b>42447103</b> 1606730  <b>42447204</b> 1606728	 <b>42447205</b> 607449 1,80mm <b>ø79,5</b>
1,4 1389	<b>4 CYL ø77,6</b> ASTRA F 01/96-->03/01 COMBO 08/99-->10/01 CORSA B 09/94-->09/00 TIGRA 07/94-->12/00 ( DOCH 16V )	90 PS / 66 KW	C 14 SEL X 14 XE	<b>42447802</b> 1606034+1606790  <b>42447803</b> 1606034  <b>42447404</b> 1606790	 <b>42447805</b> 5607410 1,40mm <b>ø79,5</b>
1,4 1389	<b>4 CYL ø77,6</b> ASTRA G 02/98-->01/05 ( DOCH 16V )	90 PS / 66 KW	X 14 XE	<b>42448402</b> 1606381+1606790  <b>42448403</b> 1606381  <b>42447404</b> 1606790	 <b>42447805</b> 5607410 1,40mm <b>ø79,5</b>
1,4 1389	<b>4 CYL ø77,6</b> CORSA C 2000--> ( DOCH 16V )	90 PS / 66 KW	Z 14 XE	<b>42448003</b> 1606097  <b>42448004</b> 1606170	 <b>42448005</b> 607410 MLS <b>ø79,3</b>

▲ : İçerikte Bulunmamaktadır...

▲ : Not included in the set

▲ : Non inclus dans la pochette

00: Motor Takım Keçesiz ve Subap Lastiksiz



















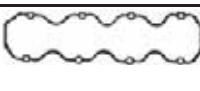





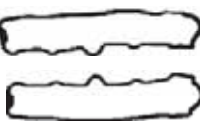





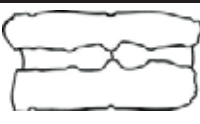

00: Gasket Set Without oil seals Without Valve Stem Seal

01: Motor Takım Keçesiz - Subap Lastikli

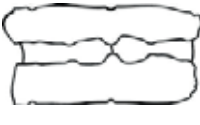
01: Gasket set With Valve Stem Seal Without Oil Seals

02: Motor Full Takım Keçeli ve Subap Lastikli

02: Gasket Full Set With oil seals and Valve Stem Seals

Subap Kapak Valve Cover Gasket Zylinderkopfhaube Couvre-culbut.	Karter Oil Pan Ölwanne Carter d'huile	Emme Manifold Intake Manifold Ansaug Admission	Egzoz Manifold Exhaust Manifold Auspuffkrümmer Collecteur D'échappement	Eksoz Boğaz Exhaust Pipe Auspuff Kehle	Supap Keçesi Valve Stem Seal Ventilschaft Queue de soupape	
						
42447235 638 727	42447265 652 577	42447219 850 634	42447221 850 615	42447517 854933	42447227x8 642527 7x11,1/16x10	21201014 35x48x7 RD
						21208013 80x98x10 LD
						21208007 26x42x8 RD
						21201014 35x48x7 RD
42447236 638 260 Kauçuk Rubber	42447265 652 577	42447319 850 607	42447221 850 615	42447517 854933	42447227x8 642527 7x11,1/16x10	21208013 80x98x10 LD
						21208007 26x42x8 RD
						21201014x2 35x48x7 RD
42447435 638736+638737	42447465 652669	42447419 850668	42447421 5850613		42447426x16 642533 6x8.8x12.2x9.7	21208013 80x98x10 LD
						21208007 26x42x8 RD
		42447818 5850615				
						21201014x2 35x48x7 RD
42448025 638742	42447465 652669	42448019 849196	42447421 5850613		42447426x16 642533 6x8.8x12.2x9.7	21208013 80x98x10 LD
						21208007 26x42x8 RD
		62448018 5850624				
						21201014x2 35x48x7 RD
42448025 638742	42447465 652669	42448019 849196	42448021 850510		42447426x16 642533 6x8.8x12.2x9.7	21208013 80x98x10 LD
						21208007 26x42x8 RD
		42448018 5850624				

■ : Delik - Çentik

■ : Hole - Notch

■ : Trou - Entaille

NOT: Katalogdaki Orijinal Kodlar Referans Amacıyla Kullanılmıştır. Lütfen Oto Conta Kodlarını Kullanınız.  
Original codes used for reference only. Please use OTO CONTA codes for orders.



OPEL

00



01



02



03



04



Silindir Kapak  
Cylinder Head  
Zylinderkopf  
Joint de culasse



Ltr	MODEL	PS/KW	ENGINE/MOTOR		
1,6 1598	4 CYL ø79 CORSA B 01/94-->12/00 TIGRA CORSA B 03/93-->09/00 ( DOCH 16V)	106 PS / 78 KW 100 PS / 74 KW 109 PS / 80 KW	C 16 SEL X 16 XE C 16 XE	42447402 1606820+1606790 42447403 1606820 42447404 1606790	 42447405 607491 1,40mm ø80,5
1,6 1598	4 CYL ø79 ASCONA C 09/84-->05/93 CORSA A KADETT E VECTRA A ASTRA F 02/93-->02/98 VECTRA A ASTRA F 09/91--> ASTRA G VECTRA B ( OHC )	102 PS / 75 KW 82 PS / 60 KW 71 PS / 52 KW 75 PS / 55 KW	E 16 SE 16SV X 16 SZ X 16 SZR 16 NZR	42447302 1606689+1606686 42447303 1606689-1606673 42447204 1606686	 42447305 5607408-607988 1,40mm ø80,5
1,6 1598	4 CYL ø79 ASTRA F 01/94-->01/05 VECTRA B ( DOCH 16V)	101 PS / 74 KW 100 PS / 74 KW	X 16 XEL	42447402 1606820+1606790 42447403 1606820-1606819 42447404 1606790	 42447405 607491 1,40mm ø80,5
1,6 1598	4 CYL ø79 ASTRA G 10/95--> VECTRA B ZAFIRA ( DOCH 16V)	101 PS / 74 KW 100 PS / 74 KW	X 16 XEL	42448502 1606380+1606790 42448503 1606380 42447404 1606790	 42447405 607491 1,40mm ø80,5
1,6 1598	4 CYL ø79 VECTRA B 10/95-->07/02 ( DOCH 16V)	101 PS / 74 KW 100 PS / 74 KW	Y 16 XE	42448303 1606130 42447404 1606790	 42448305 607407 ø80 MLS

▲ : İçerikte Bulunmamaktadır...

▲ : Not included in the set

▲ : Non inclus dans la pochette

00: Motor Takım Keçesiz ve Subap Lastiksiz



















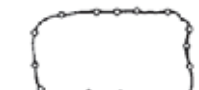









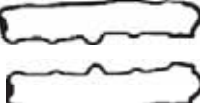



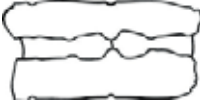
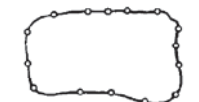

00: Gasket Set Without oil seals Without Valve Stem Seal

01: Motor Takım Keçesiz - Subap Lastikli

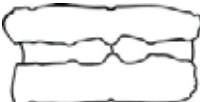
01: Gasket set With Valve Stem Seal Without Oil Seals

02: Motor Full Takım Keçeli ve Subap Lastikli

02: Gasket Full Set With oil seals and Valve Stem Seals

Subap Kapak Valve Cover Gasket Zylinderkopfhaube Couvre-culbut.	Karter Oil Pan Ölwanne Carter d'huile	Emme Manifold Intake Manifold Ansaug Admission	Egzoz Manifold Exhaust Manifold Auspuffkrümmer Collecteur D'échappement	Eksoz Boğaz Exhaust Pipe Auspuff Kehle	Supap Keçesi Valve Stem Seal Ventilschaft Queue de soupape	
						
 <b>42447435</b> 638736+638737	 <b>42447465</b> 652669	 <b>42447419</b> 850668  <b>42447818</b> 5850615	 <b>42447421</b> 5850613		 <b>42447426x16</b> 642533 6x8.8x12.2x9.7	<b>21201014x2</b> 35x48x7 RD <b>21208013</b> 80x98x10 LD <b>21208007</b> 26x42x8 RD
 <b>42447235</b> 638 727	 <b>42447265</b> 652 577	 <b>42447219</b> 850 634	 <b>42447221</b> 850 615	 <b>42447517</b> 854933	 <b>42447227x8</b> 642527 7x11,1/16x10	<b>21201014</b> 35x48x7 RD <b>21208013</b> 80x98x10 LD <b>21208007</b> 26x42x8 RD
 <b>42447435</b> 638736+638737	 <b>42447465</b> 652669	 <b>42447419</b> 850668  <b>42447818</b> 5850615	 <b>42447421</b> 5850613		 <b>42447426x16</b> 642533 6x8.8x12.2x9.7	<b>21201014x2</b> 35x48x7 RD <b>21208013</b> 80x98x10 LD <b>21208007</b> 26x42x8 RD
 <b>42448025</b> 638742	 <b>42447465</b> 652669	 <b>42448019</b> 849196  <b>42448018</b> 5850624	 <b>42447421</b> 5850613		 <b>62447426x16</b> 642533 6x8.8x12.2x9.7	<b>21201014x2</b> 35x48x7 RD <b>21208013</b> 80x98x10 LD <b>21208007</b> 26x42x8 RD
 <b>42448025</b> 638742	 <b>42447465</b> 652669	 <b>42448019</b> 849196  <b>42448018</b> 5850624	 <b>42448021</b> 850510		 <b>42447426x16</b> 642533 6x8.8x12.2x9.7	<b>21201014x2</b> 35x48x7 RD <b>21208013</b> 80x98x10 LD <b>21208007</b> 26x42x8 RD

■ : Delik - Çentik

■ : Hole - Notch

■ : Trou - Entaille

NOT: Katalogdaki Orijinal Kodlar Referans Amacıyla Kullanılmıştır.Lütfen Oto Conta Kodlarını Kullanınız.  
Original codes used for reference only.Please use OTO CONTA codes for orders.



OPEL

00



01



02



03



04



Silindir Kapak  
Cylinder Head  
Zylinderkopf  
Joint de culasse



Ltr	MODEL	PS/KW	ENGINE/MOTOR		
1,6 1598	4 CYL ø79 ASTRA H Turbo 09/05--> ASTRA J ASTRA J Turbo ASTRA S T TURBO CORSA D Turbo INSIGNIA Turbo MERIVA Turbo ZAFIRA ZAFIRA Turbo ASTRA H 12/06--> ASTRA J ASTRA S T INSIGNIA ZAFIRA ( DOCH 16V )	211 PS / 155 KW 150 PS / 110 KW  116 PS / 85 KW 115 PS / 85 KW	A 16 LEL A 16 LER A 16 LET A 16 XNT Z 16 LEL Z 16 LER Z 16 LET Z 16 XNT  A 16 XER Z 16 XER		 <b>41417005</b> 71744395 1,20mm FIBER / FIBRE  <b>41417006</b> 71744395 1,80mm FIBER / FIBRE <b>ø82</b>
1,6 1598	4 CYL ø79 ASCONA C 08/86-->09/98 ASTRA F CORSA A KADETT E VECTRA A ( OHC )	75 PS / 55 KW	C 16 NZ E 16 NZ	<b>42447302</b> 1606689+1606686  <b>42447303</b> 1606689  <b>42447204</b> 1606686	 <b>42447305</b> 5607408-607988 1,40mm <b>ø80,5</b>
1,6 1598	4 CYL ø79 ASTRA F 03/91-->02/98 CORSA A 02/92-->03/93 ( OHC )	100 PS / 74 KW 101 PS / 74 KW	C 16 SE C 16 SE	<b>42447002</b> 1606729+1606728  <b>42447003</b> 1606729  <b>42447204</b> 1606686	 <b>42447305</b> 5607408-607988 1,40mm <b>ø80,5</b>
1,6 1598	4 CYL ø79 ASTRA G 02/98-->06/05 ZAFIRA ( DOCH 16V )	101 PS / 74 KW	C 16 SEL	<b>42448502</b> 1606380+1606790  <b>42448503</b> 1606380  <b>42447404</b> 1606790	 <b>42447405</b> 607491 1,40mm <b>ø80,5</b>

▲ : İçerikte Bulunmamaktadır...

▲ : Not included in the set

▲ : Non inclus dans la pochette

00: Motor Takım Keçesiz ve Subap Lastiksiz











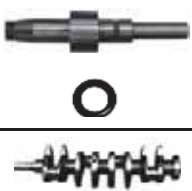











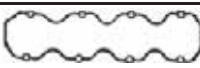

00: Gasket Set Without oil seals Without Valve Stem Seal

01: Motor Takım Keçesiz - Subap Lastikli

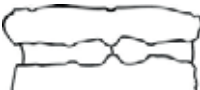
01: Gasket set With Valve Stem Seal Without Oil Seals

02: Motor Full Takım Keçeli ve Subap Lastikli

02: Gasket Full Set With oil seals and Valve Stem Seals

Subap Kapak Valve Cover Gasket Zylinderkopfhaube Couvre-culbut.	Karter Oil Pan Ölwanne Carter d'huile	Emme Manifold Intake Manifold Ansaug Admission	Egzoz Manifold Exhaust Manifold Auspuffkrümmer Collecteur D'echappement	Eksoz Boğaz Exhaust Pipe Auspuff Kehle	Supap Keçesi Valve Stem Seal Ventilschaft Queue de soupape	
						
 <b>42447235</b> 638 727	 <b>42447265</b> 652 577	 <b>42447219</b> 850 634	 <b>42447221</b> 850 615	 <b>42447517</b> 854933	 <b>42447227x8</b> 642527 7x11,1/16x10	<b>21201014</b> 35x48x7 RD  <b>21208013</b> 80x98x10 LD  <b>21208007</b> 26x42x8 RD
 <b>42447236</b> 638 260 Kauçuk Rubber	 <b>42447265</b> 652 577	 <b>42447319</b> 850 607	 <b>42447221</b> 850 615	 <b>42447517</b> 854933	 <b>42447227x8</b> 642527 7x11,1/16x10	<b>21201014</b> 35x48x7 RD  <b>21208013</b> 80x98x10 LD  <b>21208007</b> 26x42x8 RD
 <b>42448025</b> 638742	 <b>42447465</b> 652669	 <b>42448019</b> 849196  <b>42448018</b> 5850624	 <b>42447421</b> 5850613		 <b>42447426x16</b> 642533 6x8.8x12.2x9.7	<b>21201014x2</b> 35x48x7 RD  <b>21208013</b> 80x98x10 LD  <b>21208007</b> 26x42x8 RD

■ : Delik - Çentik

■ : Hole - Notch

■ : Trou - Entaille

NOT: Katalogdaki Orijinal Kodlar Referans Amacıyla Kullanılmıştır. Lütfen Oto Conta Kodlarını Kullanınız.  
Original codes used for reference only. Please use OTO CONTA codes for orders.



OPEL

00



01



02



03



04



Silindir Kapak  
Cylinder Head  
Zylinderkopf  
Joint de culasse



Ltr	MODEL	PS/KW	ENGINE/MOTOR		
1,6 1598	4 CYL ø79 ASTRA G 09/01--> ASTRA G CNG ASTRA H COMBO CNG CORSA C ZAFIRA ZAFIRA CNG ( DOCH 16V )	97 PS / 71 KW 92 PS / 69 KW	Y 16 YNG Z 16 YNG	42448303 1606130	 42448305 607407 ø80 MLS
1,6 1598	4 CYL ø79 ASTRA G 10/95--> MERIVA VECTRA B VECTRA C ZAFIRA ( DOCH 16V )	101 PS / 74 KW 100 PS / 74 KW	Z 16 XE	42448303 1606130 42448004 1606170	 42448305 607407 ø80 MLS
1,8 1796	4 CYL ø79 ASTRA H 01/04--> INSIGNIA SIGNUM VECTRA C ZAFIRA ( DOCH 16V )	140 PS / 103 KW	A 18 XER Z 18 XER		 41417005 71744395 1,20mm FIBER / FIBRE 41417006 71744395 1,80mm FIBER / FIBRE ø82
1,8 1796	4 CYL ø84,8 ASCONA C 08/84-->09/92 KADETT E ASCONA C 01/85-->09/98 ASTRA F KADETT E OMEGA A VECTRA A ( OHC )	100 PS / 74 KW 90 PS / 66 KW 100 PS / 74 KW 82 PS / 60 KW	C 18 NE C 18 NT C 18 NZ E 18 NV E 18 NVR S 18 NV 18 NV 18 SV	42447502 62447503+62447504 42447503 1606682-1606666 42447504 1606663	 42447505 607986 1,40mm ø86,3
1,8 1796	4 CYL ø81,6 VECTRA B 10/95-->09/00 ( DOCH 16V )	116 PS / 85 KW 115 PS / 85 KW	X 18 XE	42448603 1606914	 42448605 608809 1,40mm ø83

▲ : İçerikte Bulunmamaktadır...

▲ : Not included in the set

▲ : Non inclus dans la pochette

00: Motor Takım Keçesiz ve Subap Lastiksiz











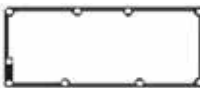





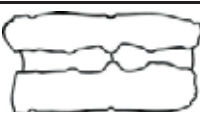



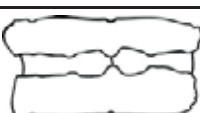







00: Gasket Set Without oil seals Without Valve Stem Seal

01: Motor Takım Keçesiz - Subap Lastikli

01: Gasket set With Valve Stem Seal Without Oil Seals

02: Motor Full Takım Keçeli ve Subap Lastikli

02: Gasket Full Set With oil seals and Valve Stem Seals

Subap Kapak Valve Cover Gasket Zylinderkopfhaube Couvre-culbut.	Karter Oil Pan Ölwanne Carter d'huile	Emme Manifold Intake Manifold Ansaug Admission	Egzoz Manifold Exhaust Manifold Auspuffkrümmer Collecteur D'echappement	Eksoz Boğaz Exhaust Pipe Auspuff Kehle	Supap Keçesi Valve Stem Seal Ventilschaft Queue de soupape	
						
 <b>42448025</b> 638742		 <b>42448019</b> 849196  <b>42448018</b> 5850624	 <b>42448021</b> 850510		 <b>42447426x16</b> 642533 6x8.8x12.2x9.7	<b>21201014x2</b> 35x48x7 RD
 <b>42448025</b> 638742	 <b>42447465</b> 652669	 <b>42448019</b> 849196  <b>42448018</b> 5850624	 <b>42448021</b> 850510		 <b>42447426x16</b> 642533 6x8.8x12.2x9.7	<b>21201014x2</b> 35x48x7 RD <b>21208013</b> 80x98x10 LD <b>21208007</b> 26x42x8 RD
 <b>42447534</b> 638192	 <b>42447564</b> 652587	 <b>42447518</b> 850600  <b>42447719</b> 850601	 <b>42447521</b> 850645	 <b>42447517</b> 854933	 <b>42447227x8</b> 642527 7x11,1/16x10	<b>21201014</b> 35x48x7 RD <b>21208020</b> 31x50x8 RD <b>21208019</b> 90x104x11 LD
 <b>42447625</b> 607647		 <b>42447619</b> 850655	 <b>42447621</b> 850656	 <b>42447517</b> 854933	 <b>42447426x16</b> 642533 6x8.8x12.2x9.7	<b>21201014x2</b> 35x48x7 RD

■ : Delik - Çentik

■ : Hole - Notch

■ : Trou - Entaille

NOT: Katalogdaki Orijinal Kodlar Referans Amacıyla Kullanılmıştır. Lütfen Oto Conta Kodlarını Kullanınız.  
Original codes used for reference only. Please use OTO CONTA codes for orders.



OPEL

00



Silindir Kapak  
Cylinder Head

01



Zylinderkopf

02



Joint de culasse

03



04



Ltr	MODEL	PS/KW	ENGINE/MOTOR		
1,8 1796	4 CYL ø81,6 ASTRA F 06/93-->03/01 ASTRA F 07/94-->03/01 ( DOCH 16V )	125 PS / 92 KW 115 PS / 85 KW 116 PS / 85 KW	C 18 XE C 18 XEL X 18 XE		 <b>42448605</b> 608809 1,40mm ø83
1,8 1796	4 CYL ø80,5 ASTRA F 02/98-->10/00 ASTRA G 04/02--> VECTRA C ZAFIRA VECTRA B 10/95-->07/03 ASTRA G 09/00--> ASTRA H CORSA C MERIVA SIGNUM TIGRA VECTRA C ZAFIRA ( DOCH 16V )	116 PS / 85 KW 110 PS / 81 KW 125 PS / 92 KW 115 PS / 85 KW 125 PS / 92 KW 122 PS / 90 KW	X 18 XE1 Z 18 XEL X 18 XE1 Z 18 XE Z 18 XE		 <b>42448205</b> 5607858 MLS ø81,5
1,8 1796	4 CYL ø84,8 ASTRA F 09/81-->02/98 OMEGA A 09/86-->03/94 ( OHC )	116 PS / 85 KW 111 PS / 82 KW 115 PS / 85 KW	18 SE 18 SEH	<b>42447502</b> 62447503+62447504 <b>42447503</b> 1606682-1606666 <b>42447504</b> 1606663	 <b>42447505</b> 607986 1,40mm ø86,3
1,9 1870	4 CYL ø80 ARENA D 03/98-->08/01	60 PS / 44 KW	F8Q 600 F8Q 606		 <b>40152005</b> 44 01 561 1,60mm 3 <b>40152006</b> 44 01 518 1,50mm 1 <b>40152007</b> 44 01 560 1,40mm 2 ø81

▲ : İçerikte Bulunmamaktadır...

▲ : Not included in the set

▲ : Non inclus dans la pochette

00: Motor Takım Keçesiz ve Subap Lastiksiz











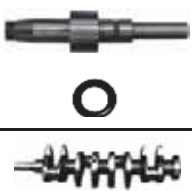



00: Gasket Set Without oil seals Without Valve Stem Seal

01: Motor Takım Keçesiz - Subap Lastikli

01: Gasket set With Valve Stem Seal Without Oil Seals

02: Motor Full Takım Keçeli ve Subap Lastikli

02: Gasket Full Set With oil seals and Valve Stem Seals

Subap Kapak Valve Cover Gasket Zylinderkopfhaube Couvre-culbut.	Karter Oil Pan Ölwanne Carter d'huile	Emme Manifold Intake Manifold Ansaug Admission	Egzoz Manifold Exhaust Manifold Auspuffkrümmer Collecteur D'echappement	Eksoz Boğaz Exhaust Pipe Auspuff Kehle	Supap Keçesi Valve Stem Seal Ventilschaft Queue de soupape	
						
 <b>42447534</b> 638192	 <b>42447564</b> 652587	 <b>42447518</b> 850600  <b>42447719</b> 850601	 <b>42447521</b> 850645	 <b>42447517</b> 854933	 <b>42447227x8</b> 642527 <b>7x11,1/16x10</b>	<b>21201014</b> 35x48x7 RD <b>21208020</b> 31x50x8 RD <b>21208019</b> 90x104x11 LD

■ : Delik - Çentik

■ : Hole - Notch

■ : Trou - Entaille

NOT: Katalogdaki Orijinal Kodlar Referans Amacıyla Kullanılmıştır.Lütfen Oto Conta Kodlarını Kullanınız.  
Original codes used for reference only.Please use OTO CONTA codes for orders.















OPEL



Silindir Kapak  
Cylinder Head  
Zylinderkopf  
Joint de culasse



Ltr	MODEL	PS/KW	ENGINE/MOTOR		
1,9 1870	4 CYL ø80 MOVANO DTI 09/00-->	82 PS / 60 KW 80 PS / 59 KW	F9Q 770 F9Q 772	<b>40152102</b> Motor Full Takım Gasket Full Set  <b>40152103</b> 44 02 544  <b>40152104</b> 77 01 470 176	 <b>40152105</b> 44 02 582 1,45mm 1  <b>40152106</b> 44 02 581 1,35mm 2  <b>40152107</b> 44 02 583 1,55mm 3  ø81
1,9 1910	4 CYL ø82 ASTRA H CDTI 01/04--> SIGNUM CDTI VECTRA C CDTI ZAFIRA CDTI	120 PS / 88 KW 100 PS / 74 KW	Z 19 DT Z 19 DTL	<b>42427802</b> Motor Full Takım Gasket Full Set  <b>42427803</b> 16 06 329  <b>42427704</b> 16 06 336	 <b>42427805</b> 56 07 843 0,82mm ø83 <b>42427806</b> 56 07 845 0,92mm 1  ø83 <b>42427807</b> 56 07 847 1,02mm 2  MLS ø83
2,0 1998	4 CYL ø86 ASCONA C 09/86-->09/98 ASTRA F CALIBRA A KADETT E OMEGA A VECTRA A ( OHC )	130 PS / 95 KW 99 PS 73 KW	C 20 NE C 20 NEF C 20 NEJ 20 NE 20 SEH 20 SER	<b>42447700</b> <b>42447702</b> 1606664+1606663 <b>42447703</b> 1606664 <b>42447504</b> 1606663	 <b>42447705</b> 607987 1,30mm ø87,5

▲ : İçerikte Bulunmamaktadır...

▲ : Not included in the set

▲ : Non inclus dans la pochette

00: Motor Takım Keçesiz ve Subap Lastiksiz











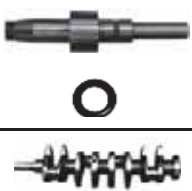









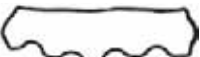

00: Gasket Set Without oil seals Without Valve Stem Seal

01: Motor Takım Keçesiz - Subap Lastikli

01: Gasket set With Valve Stem Seal Without Oil Seals

02: Motor Full Takım Keçeli ve Subap Lastikli

02: Gasket Full Set With oil seals and Valve Stem Seals

Subap Kapak Valve Cover Gasket Zylinderkopfhaube Couvre-culbut.	Karter Oil Pan Ölwanne Carter d'huile	Emme Manifold Intake Manifold Ansaug Admission	Egzoz Manifold Exhaust Manifold Auspuffkrümmer Collecteur D'echappement	Eksoz Boğaz Exhaust Pipe Auspuff Kehle	Supap Keçesi Valve Stem Seal Ventilschaft Queue de soupape	
						
 <b>40152025</b> 44 08 006	 <b>40152065</b> 44 02 981	 <b>40152121</b> 44 02 641			 <b>40116026x8</b> 44 12 186 7x9,8/13.2x10	<b>21204002</b> 25x42x8 RD
 <b>42427825</b> 56 07 165	 <b>42427465</b>	 <b>42427820</b> 58 50 828	 <b>42427821</b> 58 49 907		 <b>40107027x8</b> 44 01 804 8x10,8/14,2x10	<b>21208003</b> 30x42x7 RD
						<b>21201100</b> 31x41x7 RD
 <b>42447534</b> 638192	 <b>42447564</b> 652587	 <b>42447719</b> 850601	 <b>42447521</b> 850645	 <b>42447517</b> 854933	 <b>42447227x8</b> 642527 7x11,1/16x10	<b>21201014</b> 35x48x7 RD
						<b>21208020</b> 31x50x8 RD
						<b>21208019</b> 90x104x11 LD

■ : Delik - Çentik

■ : Hole - Notch

■ : Trou - Entaille

NOT: Katalogdaki Orijinal Kodlar Referans Amacıyla Kullanılmıştır.Lütfen Oto Conta Kodlarını Kullanınız.  
Original codes used for reference only.Please use OTO CONTA codes for orders.



OPEL

00



Silindir Kapak  
Cylinder Head

01



Zylinderkopf

02



Joint de culasse

03



04



Ltr	MODEL	PS/KW	ENGINE/MOTOR		
2,0 1998	4 CYL ø82,7 VIVARO 08/01--> VIVARO 08/06-->	120 PS 88 KW 117 PS / 86 KW	F4R 720 F4R 820		 <b>42457305</b> 77 00 108 254 MLS ø84
2,0 1998	4 CYL ø86 FRONTERA A 03/92-->10/98 OMEGA B 03/94-->09/99 ( OHC )	115 PS / 85 KW 116 PS / 85 KW	X 20 SE X 20 SE		 <b>42447705</b> 607987 1,30mm ø87,5
2,0 1998	4 CYL ø86 ASTRA G 11/99-->09/02 ( DOCH 16V )	160 PS / 118 KW	X 20 XER	<b>42447603</b> 1606770	 <b>42447605</b> 5607409 1,30mm ø87,5
2,0 1998	4 CYL ø86 ASTRA F 01/94-->01/98 ASTRA G CALIBRA A OMEGA B VECTRA A VECTRA B ( DOCH 16V )	136 PS / 100 KW	X 20 XEV	<b>42447603</b> 1606770	 <b>42447605</b> 5607409 1,30mm ø87,5
2,0 1998	4 CYL ø86 VECTRA B 10/95-->04/02 OMEGA B 03/94-->12/00 ( OHC )	112 PS / 82 KW 115 PS / 85 KW	20 NEJ 20 SE		 <b>42447705</b> 607987 1,30mm ø87,5

▲ : İçerikte Bulunmamaktadır...

▲ : Not included in the set

▲ : Non inclus dans la pochette

00: Motor Takım Keçesiz ve Subap Lastiksiz











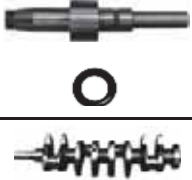



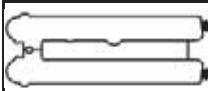

00: Gasket Set Without oil seals Without Valve Stem Seal

01: Motor Takım Keçesiz - Subap Lastikli

01: Gasket set With Valve Stem Seal Without Oil Seals

02: Motor Full Takım Keçeli ve Subap Lastikli

02: Gasket Full Set With oil seals and Valve Stem Seals

Subap Kapak Valve Cover Gasket Zylinderkopfhaube Couvre-culbut.	Karter Oil Pan Ölwanne Carter d'huile	Emme Manifold Intake Manifold Ansaug Admission	Egzoz Manifold Exhaust Manifold Auspuffkrümmer Collecteur D'echappement	Eksoz Boğaz Exhaust Pipe Auspuff Kehle	Supap Keçesi Valve Stem Seal Ventilschaft Queue de soupape	
						
 <b>42447625</b> 607647		 <b>42447619</b> 850655	 <b>42447621</b> 850656		 <b>42447426x16</b> 642533 6x8.8x12.2x9.7	<b>21201014x2</b> 35x48x7 RD
 <b>42447625</b> 607647		 <b>42447619</b> 850655	 <b>42447621</b> 850656		 <b>42447426x16</b> 642533 6x8.8x12.2x9.7	<b>21201014x2</b> 35x48x7 RD

■ : Delik - Çentik

■ : Hole - Notch

■ : Trou - Entaille

NOT: Katalogdaki Orijinal Kodlar Referans Amacıyla Kullanılmıştır.Lütfen Oto Conta Kodlarını Kullanınız.  
Original codes used for reference only.Please use OTO CONTA codes for orders.



OPEL

00



01



02



03



04



Silindir Kapak  
Cylinder Head  
Zylinderkopf  
Joint de culasse



Ltr	MODEL	PS/KW	ENGINE/MOTOR		
2,0 1998	4 CYL ø86 OMEGA A ( OHC ) 09/86-->03/94	122 PS / 90 KW	20 SE	42447700 42447702 1606664+1606663 42447703 1606664 42447504 1606663	 42447705 607987 1,30mm ø87,5
2,2 2198	4 CYL ø86 VECTRA B ( DOCH 16V ) 09/00-->07/03	147 PS / 108 KW	C 22 SEL	42447603 1606770	 42447605 5607409 1,30mm ø87,5
2,2 2198	4 CYL ø86 FRONTERA B 10/98--> FRONTERA A 03/95-->10/98 SINTRA 11/96-->04/99 OMEGA B 09/99-->07/03 ( DOCH 16V )	136 PS / 100 KW 136 PS / 100 KW 141 PS / 104 KW 144 PS / 104 KW	X 22 SE Y 22 SE X 22 SE X 22 XE Y 22 XE Z 22 XE		 42447605 5607409 1,30mm ø87,5

▲ : İçerikte Bulunmamaktadır...

▲ : Not included in the set

▲ : Non inclus dans la pochette

00: Motor Takım Keçesiz ve Subap Lastiksiz



















00: Gasket Set Without oil seals Without Valve Stem Seal

01: Motor Takım Keçesiz - Subap Lastikli

01: Gasket set With Valve Stem Seal Without Oil Seals

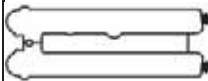
02: Motor Full Takım Keçeli ve Subap Lastikli

02: Gasket Full Set With oil seals and Valve Stem Seals

Subap Kapak Valve Cover Gasket Zylinderkopfhaube Couvre-culbut.	Karter Oil Pan Ölwanne Carter d'huile	Emme Manifold Intake Manifold Ansaug Admission	Egzoz Manifold Exhaust Manifold Auspuffkrümmer Collecteur D'echappement	Eksoz Boğaz Exhaust Pipe Auspuff Kehle	Supap Keçesi Valve Stem Seal Ventilschaft Queue de soupape	
						
 <b>42447534</b> 638192	 <b>42447564</b> 652587	 <b>42447719</b> 850601	 <b>42447521</b> 850645	 <b>42447517</b> 854933	 <b>42447227x8</b> 642527 7x11,1/16x10	<b>21201014</b> 35x48x7 RD
 <b>42447625</b> 607647		 <b>42447619</b> 850655	 <b>42447621</b> 850656		 <b>42447426x16</b> 642533 6x8.8x12.2x9.7	<b>21208020</b> 31x50x8 RD
						<b>21208019</b> 90x104x11 LD
						<b>21201014x2</b> 35x48x7 RD

■ : Delik - Çentik

■ : Hole - Notch

■ : Trou - Entaille

NOT: Katalogdaki Orijinal Kodlar Referans Amacıyla Kullanılmıştır.Lütfen Oto Conta Kodlarını Kullanınız.  
Original codes used for reference only.Please use OTO CONTA codes for orders.



PEUGEOT

00



01



02



03



04



Silindir Kapak  
Cylinder Head  
Zylinderkopf  
Joint de culasse



Ltr	MODEL	PS/KW	ENGINE/MOTOR		
1,0 954	4 CYL ø70 104 205 10/72-->10/83	46 PS / 34 KW 45 PS / 33 KW	XV3 (108) XV5(108)	41216002 198,57	 41216005 0203.84 1,20mm Loc ø16mm 41216006 0203.22 1,40mm ø74
1,0 954	4 CYL ø70 106 205 10/87-->	50 PS / 37 KW 45 PS / 33 KW	TU9 TU9M (CDY) TU9M (CDZ)	41221002 Motor Full Takım Gasket Full Set 41221003 0197.H8+0209.89 41209004 0197.H9	 41221005 0209.89 1,30mm 1 ■ 41221006 0209.90 1,50mm 2 ■ ø73,5
1,0 999	4 CYL ø69 206 16V ( DOCH ) 2000-->	75 PS / 55 KW	D4D	40108603 77 01 473 003	 40108605 8200062273 MLS ø70
1,1 1118	4 CYL ø74 309 10/85-->07/89	54 PS / 40 KW	E1		 41208005 0209.H9 1,20mm ø77
1,1 1124	4 CYL ø72 PARTNER 106 206 206 SW 05/96-->	60 PS / 44 KW	TU1JP (HFX) TU1JP (HFZ)		 41222005 0209.Y0 1,30mm 1 ■ 41222006 0209.Y1 1,50mm 2 ■ ø74

▲ : İçerikte Bulunmamaktadır...

▲ : Not included in the set

▲ : Non inclus dans la pochette

00: Motor Takım Keçesiz ve Subap Lastiksiz



















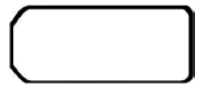
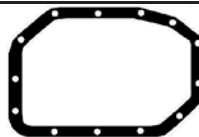





00: Gasket Set Without oil seals Without Valve Stem Seal

01: Motor Takım Keçesiz - Subap Lastikli

01: Gasket set With Valve Stem Seal Without Oil Seals

02: Motor Full Takım Keçeli ve Subap Lastikli

02: Gasket Full Set With oil seals and Valve Stem Seals

Subap Kapak Valve Cover Gasket Zylinderkopfhaube Couvre-culbut.	Karter Oil Pan Ölwanne Carter d'huile	Emme Manifold Intake Manifold Ansaug Admission	Egzoz Manifold Exhaust Manifold Auspuffkrümmer Collecteur D'echappement	Eksoz Boğaz Exhaust Pipe Auspuff Kehle	Supap Keçesi Valve Stem Seal Ventilschaft Queue de soupape	
						
 41201525 0249.39	 41201013 0304.46	 41201018 0384.54	 41201020 0349.16	 41205017 7700657683	 40107027x8 956,22 8x10.8/14.2x10	21201013 35x50x8 WD  21201033 78x100x10 LD
 41209025 0249.54	 41209013 0304.304	 41209019x2	 41209020x2 0349,A6	 41209017 1709.15	 40116026x8 0956.19 7x9,8/13.2x10	21201062 36x50x7 RD  21201021 42x66x6 RD  21204504 85x105x8 LD
 40108625 77 01 049 888	 42427465	 40108618 77 01 473 007	 40108621 77 00 115 971		 40108626x16 5,5x11x23x15,7	21204701 28x47x8 RD

■ : Delik - Çentik

■ : Hole - Notch

■ : Trou - Entaille

NOT: Katalogdaki Orijinal Kodlar Referans Amacıyla Kullanılmıştır.Lütfen Oto Conta Kodlarını Kullanınız.  
Original codes used for reference only.Please use OTO CONTA codes for orders.



PEUGEOT

00



01



02



03



04



Silindir Kapak  
Cylinder Head  
Zylinderkopf  
Joint de culasse



Ltr	MODEL	PS/KW	ENGINE/MOTOR		
1,1 1124	4 CYL ø72 PARTNER 09/96--> 106 306	60 PS / 44 KW	TU1M+ HDY (TU1M) HDZ(TU1M)	41221002 Motor Full Takım Gasket Full Set  41221003 0197.H8+0209.89  41209004 0197.H9	 41221005 0209.89 1,30mm 1  41221006 0209.90 1,50mm 2 ø73,5
1,1 1124	4 CYL ø75 PARTNER 09/91--> 106 306 205 07/89-->09/98 309	60 PS / 44 KW 54 PS / 40 KW 60 PS / 44 KW	TU1M (HDY) TU1M (HDZ)  TU1M (HDZ)	41209002 Motor Full Takım Gasket Full Set  41209003 0197.H8+0209.CJ  41209004 0197.H9	 41209005 0209.CJ 1,30mm 1  41209006 0209.W6 - W7 1,50 mm 2 ø76
1,1 1127	4 CYL ø78 204 09/75-->12/88 304 305	58 PS / 43 KW	XK5	41206002 0197.91	 41206005 0209.G7 1,30mm ø80,5
1,1 1130	4 CYL ø75 204 10/65-->10/77	55 PS / 40 KW 53 PS / 39 KW	XK XK4	41205002 0199.58	 41205005 0199.75 1,20mm ø78
1,2 1204	4 CYL ø74 205 01/87-->12/90	64 PS / 47 KW	F1		 41208005 0209.H9 1,20mm ø77

▲ : İçerikte Bulunmamaktadır...

▲ : Not included in the set

▲ : Non inclus dans la pochette

00: Motor Takım Keçesiz ve Subap Lastiksiz

00: Gasket Set Without oil seals Without Valve Stem Seal





























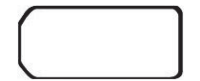
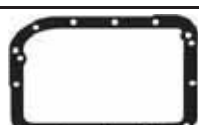

01: Motor Takım Keçesiz - Subap Lastikli

01: Gasket set With Valve Stem Seal Without Oil Seals

02: Motor Full Takım Keçeli ve Subap Lastikli

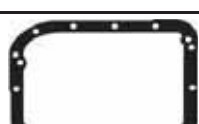
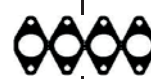
02: Gasket Full Set With oil seals and Valve Stem Seals

203

Subap Kapak Valve Cover Gasket Zylinderkopfhaube Couvre-culbut.	Karter Oil Pan Ölwanne Carter d'huile	Emme Manifold Intake Manifold Ansaug Admission	Egzoz Manifold Exhaust Manifold Auspuffkrümmer Collecteur D'echappement	Eksoz Boğaz Exhaust Pipe Auspuff Kehle	Supap Keçesi Valve Stem Seal Ventilschaft Queue de soupape	
						
						<b>21201062</b> 36x50x7 RD
<b>41209025</b> 0249.54	<b>41209013</b> 0304.304	<b>41209019x2</b>	<b>41209020x2</b> 0349,A6	<b>41209017</b> 1709.15	<b>40116026x8</b> 0956.19 7x9,8/13.2x10	<b>21201021</b> 42x66x6 RD
						<b>21201062</b> 36x50x7 RD
<b>41209025</b> 0249.54	<b>41209013</b> 0304.304	<b>41209019x2</b>	<b>41209020x2</b> 0349,A6	<b>41209017</b> 1709.15	<b>40116026x8</b> 0956.19 7x9,8/13.2x10	<b>21201021</b> 42x66x6 RD
						<b>21201018</b> 40x49,6x7.3 LD
<b>41205025</b> 0249.21	<b>41205013</b> 0304.09	<b>41205020</b> 0349.23	<b>41205017</b> 1710.09		<b>41205018</b> 1710.11	<b>21201029</b> 60,5x78x9 RD
						<b>21201018</b> 40x49,6x7.3 LD
<b>41205025</b> 0249.21	<b>41205013</b> 0304.09	<b>41205020</b> 0349.23	<b>41205017</b> 1710.09	<b>41205018</b> 1710.11		<b>21201029</b> 60,5x78x9 RD

■ : Delik - Çentik

■ : Hole - Notch

■ : Trou - Entaille

NOT: Katalogdaki Orijinal Kodlar Referans Amacıyla Kullanılmıştır.Lütfen Oto Conta Kodlarını Kullanınız.  
Original codes used for reference only.Please use OTO CONTA codes for orders.



# PEUGEOT

00



01



02



03



04



Silindir Kapak  
Cylinder Head  
Zylinderkopf  
Joint de culasse



Ltr	MODEL	PS/KW	ENGINE/MOTOR		
1,3 1290	<b>4 CYL ø78</b> 304 09/70-->10/80 305 11/77-->08/86	75 PS / 55 KW 65 PS / 48 KW 60 PS / 44 KW	118(XL5) XL5 XL5S	<b>41206002</b> 0197.91	 <b>41206005</b> 0209.G7 1,30mm ø80,5
1,3 1290	<b>4 CYL ø75</b> 304 10/69-->07/76	75 PS / 55 KW 65 PS / 48 KW	XL3 XL3S	<b>41205002</b> 0199.58	 <b>41205005</b> 0199.75 1,20mm ø78
1,3 1294	<b>4 CYL ø75</b> 205 RALLYE 10/87-->10/90	101 PS / 74 KW	TU24	<b>41209002</b> Motor Full Takım Gasket Full Set <b>41209003</b> 0197.H8+0209.CJ <b>41209004</b> 0197.H9	 <b>41209005</b> 0209.CJ 1,30mm 1 <b>41209006</b> 0209.W6 - W7 1,50 mm 2 ø76
1,4 1360	<b>4 CYL ø75</b> 205 02/83-->10/87	60 PS / 44 KW 79 PS / 58 KW 80 PS / 59 KW	150(XY6B) 150B(XY8) 150D(XY7) 150G(XY7) 150H(XY8)	<b>41201002</b> 0197.77	 <b>41201005</b> 0209.A6 1,30mm Loc 14mm ø76
1,4 1360	<b>4 CYL ø75</b> PARTNER 07/88--> 1007 106 205 206 206 SW 306 307	75 PS / 55 KW	KFV (TU3JP) KDX(TU3MC)	<b>41209002</b> Motor Full Takım Gasket Full Set <b>41209003</b> 0197.H8+0209.CJ <b>41209004</b> 0197.H9	 <b>41209005</b> 0209.CJ 1,30mm 1 <b>41209006</b> 0209.W6 - W7 1,50 mm 2 ø76

▲ : İçerikte Bulunmamaktadır...

▲ : Not included in the set

▲ : Non inclus dans la pochette

00: Motor Takım Keçesiz ve Subap Lastiksiz

00: Gasket Set Without oil seals Without Valve Stem Seal



















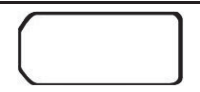



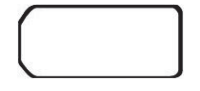











01: Motor Takım Keçesiz - Subap Lastikli

01: Gasket set With Valve Stem Seal Without Oil Seals

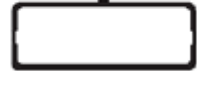
02: Motor Full Takım Keçeli ve Subap Lastikli

02: Gasket Full Set With oil seals and Valve Stem Seals

205

Subap Kapak Valve Cover Gasket Zylinderkopfhaube Couvre-culbut.	Karter Oil Pan Ölwanne Carter d'huile	Emme Manifold Intake Manifold Ansaug Admission	Egzoz Manifold Exhaust Manifold Auspuffkrümmer Collecteur D'échappement	Eksoz Boğaz Exhaust Pipe Auspuff Kehle	Supap Keçesi Valve Stem Seal Ventilschaft Queue de soupape	
						
 <b>41205025</b> 0249.21	 <b>41205013</b> 0304.09	 <b>41205020</b> 0349.23		 <b>41205017</b> 1710.09  <b>41205018</b> 1710.11		<b>21201018</b> 40x49,6x7.3 LD <b>21201029</b> 60,5x78x9 RD
 <b>41205025</b> 0249.21	 <b>41205013</b> 0304.09	 <b>41205020</b> 0349.23		 <b>41205017</b> 1710.09  <b>41205018</b> 1710.11		<b>21201018</b> 40x49,6x7.3 LD <b>21201029</b> 60,5x78x9 RD
 <b>41209025</b> 0249.54	 <b>41209013</b> 0304.304	 <b>41209019x2</b>	 <b>41209020x2</b> 0349,A6	 <b>41209017</b> 1709.15	 <b>40116026x8</b> 0956.19 7x9,8/13.2x10	<b>21201062</b> 36x50x7 RD <b>21201021</b> 42x66x6 RD <b>21204504</b> 85x105x8 LD
 <b>41201525</b> 0249.39	 <b>41201013</b> 0304.46	 <b>41201018</b> 0384.54	 <b>41201020</b> 0349.16	 <b>41205017</b> 7700657683	 <b>40107027x8</b> 956,22 8x10.8/14.2x10	<b>21201013</b> 35x50x8 WD <b>21201033</b> 78x100x10 LD
 <b>41209025</b> 0249.54	 <b>41209013</b> 0304.304	 <b>41209019x2</b>	 <b>41209020x2</b> 0349,A6	 <b>41209017</b> 1709.15	 <b>40116026x8</b> 0956.19 7x9,8/13.2x10	<b>21201062</b> 36x50x7 RD <b>21201021</b> 42x66x6 RD <b>21204504</b> 85x105x8 LD

■ : Delik - Çentik

■ : Hole - Notch

■ : Trou - Entaille

NOT: Katalogdaki Orijinal Kodlar Referans Amacıyla Kullanılmıştır.Lütfen Oto Conta Kodlarını Kullanınız.  
Original codes used for reference only.Please use OTO CONTA codes for orders.



PEUGEOT

00



01



02



03



04



Silindir Kapak  
Cylinder Head  
Zylinderkopf  
Joint de culasse



Ltr	MODEL	PS/KW	ENGINE/MOTOR		
1,4 1360	4 CYL ø75 PARTNER 01/87--> 106 205 306 309 405	84 PS / 62 KW 60 PS / 44 KW	TU 3 TU3A (K1D) TU3CP (KAY) TU3M (KDY) TU3M (KDZ) TU3MC (KDX) TU3S (K2B) TU3	41209002 Motor Full Takım Gasket Full Set 41209003 0197.H8+0209.CJ 41209004 0197.H9	 41209005 0209.CJ 1,30mm 1 41209006 0209.W6 - W7 1,50 mm 2 ø76
1,4 1360	4 CYL ø75 1007 16V 10/03--> 206 SW 16V 206 16V 207 307 SW 16V 307 16V	88 PS / 65 KW	ET3J4 (KFU)		 42190005 0209.CH 0209.FL 1,40mm ø76
1,4 1398	4 CYL ø74 1007 HDI 09/01--> 206 HDI 206 SW HDI 207 HDI 307 HDi 307 HDI	68 PS / 50 KW	DV4TD (8HX) DV4TD (8HZ)	41706002 Motor Full Takım Gasket Full Set  41706003 Motor Üst Takım Gasket Head Set  41706004 Motor Alt Takım Conversion Set	 41706005 0209.AH 1,45mm 5 41706006 0209.AG 1,40mm 4 41706007 0209.AE 1,30mm 3 41706008 0209.AC 1,25mm 2 41706009 0209.AF 1,35mm 1 MLS ø75
1,5 1472	4 CYL ø78 305 11/79-->07/90	88 PS / 65 KW 68 PS / 50 KW	XR5 (142) XR5A (142) XR5S (117)	41206002 0197.91	 41206005 0209.G7 1,30mm ø80,5

▲ : İçerikte Bulunmamaktadır...

▲ : Not included in the set

▲ : Non inclus dans la pochette

00: Motor Takım Keçesiz ve Subap Lastiksiz





















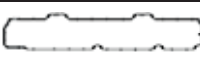

00: Gasket Set Without oil seals Without Valve Stem Seal

01: Motor Takım Keçesiz - Subap Lastikli

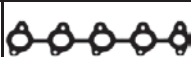
01: Gasket set With Valve Stem Seal Without Oil Seals

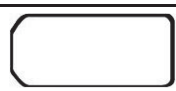
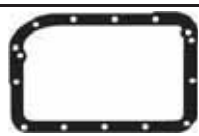
02: Motor Full Takım Keçeli ve Subap Lastikli

02: Gasket Full Set With oil seals and Valve Stem Seals

Subap Kapak Valve Cover Gasket Zylinderkopfhaube Couvre-culbut.	Karter Oil Pan Ölwanne Carter d'huile	Emme Manifold Intake Manifold Ansaug Admission	Egzoz Manifold Exhaust Manifold Auspuffkrümmer Collecteur D'echappement	Eksoz Boğaz Exhaust Pipe Auspuff Kehle	Supap Keçesi Valve Stem Seal Ventilschaft Queue de soupape	
						
						<b>21201062</b> 36x50x7 RD
<b>41209025</b> 0249.54	<b>41209013</b> 0304.304	<b>41209019x2</b>	<b>41209020x2</b> 0349,A6	<b>41209017</b> 1709.15	<b>40116026x8</b> 0956.19 7x9,8/13.2x10	<b>21201021</b> 42x66x6 RD
						<b>21204504</b> 85x105x8 LD
						<b>21204017</b> 27x47x7 RD
<b>41706025</b> 0249.C1 0249.F8	<b>42427465</b>	<b>41706019x4</b> 0348.R2 0348.T8	<b>41706021</b> 0349.J8 0349.J7		<b>41706027x8</b> 0956.50 5,5x9,5x22,9x17,5	<b>21204018</b> 40x55x6,4 LD
						<b>21204019</b> 85x105x8,8 RD
						<b>21201018</b> 40x49,6x7.3 LD
<b>41205025</b> 0249.21	<b>41205013</b> 0304.09	<b>41205020</b> 0349.23	<b>41205018</b> 1710.11	<b>41205017</b> 1710.09		<b>21201029</b> 60,5x78x9 RD

■ : Delik - Çentik

■ : Hole - Notch

■ : Trou - Entaille

NOT: Katalogdaki Orijinal Kodlar Referans Amacıyla Kullanılmıştır.Lütfen Oto Conta Kodlarını Kullanınız.  
Original codes used for reference only.Please use OTO CONTA codes for orders.



PEUGEOT

00



01



02



03















04



Silindir Kapak  
Cylinder Head  
Zylinderkopf  
Joint de culasse



Ltr	MODEL	PS/KW	ENGINE/MOTOR		
1,6 1560	4 CYL ø75 EXPRESS TD 02/04--> PARTNER HDI 1007 HDI 206 CC HDI FAP 110 206 HDI FAP 110 206 SW HDI FAP 110 207 CC HDI 207 HDI 3008 HDI 307 D 307 HDI 307 HDI 110 FAP 307 SW HDI 110 FAP 308 HDI 407 HDI 110 FAP 407 SW HDI 110 FAP 5008 HDI	110 PS / 80 KW 90 PS / 66 KW	DV6ATED4 (9HX) DV6TED4 (9HY) DV6TED4 (9HZ)	<b>41707002</b> Motor Full Takım Gasket Full Set  <b>41707003</b> Motor Üst Takım Gasket Head Set  <b>41707004</b> Motor Alt Takım Conversion Set	 <b>41707005</b> 0209.CG 1,45mm 5  <b>41707006</b> 0209.CF 1,40mm 4  <b>41707007</b> 0209.CC 1,30mm 3  <b>41707008</b> 0209.CA 1,25mm 2  <b>41707009</b> 0209.CE 1,35mm 1  MLS ø76
1,6 1580	4 CYL ø83 205 10/82--> 205 GTI 305 309	103 PS / 76 KW 72 PS / 53 KW	XU5CP (BAZ) XU5J (B6B) XU5J (180A) XU5J (180Z) XU5S (171) XU51C (B1A) XU51C (B1D) XU51C (B1E)	<b>41207002</b> 0197.89+0209.E1 <b>41207003</b> 0197.H6+0209.E1 <b>42130002</b> 0197.89+0209.L3 <b>42130003</b> 0197.H6+0209.L3	 <b>41207005</b> 0209.E1 1,30mm 1  <b>41207006</b> 0209.L8 1,50mm 2   <b>42130005</b> 0209.L3 1,50mm ø84,5

▲ : İçerikte Bulunmamaktadır...

▲ : Not included in the set

▲ : Non inclus dans la pochette

00: Motor Takım Keçesiz ve Subap Lastiksiz

























00: Gasket Set Without oil seals Without Valve Stem Seal

01: Motor Takım Keçesiz - Subap Lastikli

01: Gasket set With Valve Stem Seal Without Oil Seals

02: Motor Full Takım Keçeli ve Subap Lastikli

02: Gasket Full Set With oil seals and Valve Stem Seals

Subap Kapak Valve Cover Gasket Zylinderkopfhaube Couvre-culbut.	Karter Oil Pan Ölwanne Carter d'huile	Emme Manifold Intake Manifold Ansaug Admission	Egzoz Manifold Exhaust Manifold Auspuffkrümmer Collecteur D'echappement	Eksoz Boğaz Exhaust Pipe Auspuff Kehle	Supap Keçesi Valve Stem Seal Ventilschaft Queue de soupape	
						
 <b>41707025</b> 0249.C2	 <b>42427465</b>	 0348.R5 x4  0348.R4 x4 <b>41707018</b> 0348.R5+0348.R4 <b>SET</b>	 <b>41706021</b> 0349.J8 0349.J7 0349.N0 1 148 115		 <b>41707026x16</b> 0956.51 <b>5,5x9,5x18,1x14</b>	<b>21204017</b> 27x47x7 RD <b>21204018</b> 40X55X6,4 LD <b>21204019</b> 85X105X8,8 RD
 <b>41207525</b> 0249.48 91508054	 <b>41203013</b> 0304.34 93502226  <b>41203014</b> 93501565	 <b>41203018x2</b> 91508659.  <b>41207018</b> 951299280  <b>41207019</b> 0348.76	 <b>41207020x4</b> 0349.70 91505500  <b>41205019</b> 1721.01 7810024000	 <b>41207017</b> 1710.39 91511460	 <b>40107027x8</b> 0956.22 <b>8x10,8/14,2x10</b>	<b>21201062</b> 36x50x7 RD <b>21201019</b> 42x62x8 RD <b>21201040</b> 90x110x10 LD

■ : Delik - Çentik

■ : Hole - Notch

■ : Trou - Entaille

NOT: Katalogdaki Orijinal Kodlar Referans Amacıyla Kullanılmıştır.Lütfen Oto Conta Kodlarını Kullanınız.  
Original codes used for reference only.Please use OTO CONTA codes for orders.



PEUGEOT

00



01



02



03



04



Silindir Kapak  
Cylinder Head  
Zylinderkopf  
Joint de culasse



Ltr	MODEL	PS/KW	ENGINE/MOTOR		
1,6 1580	4 CYL ø83 205 205 GTI 309 405 07/87-->09/98	103 PS / 76 KW 72 PS / 53 KW	XU5CP (BAZ) XU5J (180A) XU5J (180Z) XU5M (BDY) XU5M (BDZ) XU5S (171) XU51C (B1A) XU51C (B1E) XU52C/K (B2A)	41207002 0197.89+0209.E1 41207003 0197.H6+0209.E1 42130002 0197.89+0209.L3 42130003 0197.H6+0209.L3	 41207005 0209.E1 1,30mm 1 41207006 0209.L8 1,50mm 2  42130005 0209.L3 1,50mm ø84,5
1,6 1580	4 CYL ø83 405 406 08/92-->05/04	88 PS / 65 KW	XU5JP(BFZ)	61233002 0197.G4+0209.E1	 41207005 0209.E1 1,30mm 1 41207006 0209.L8 1,50mm 2  42130005 0209.L3 1,50mm ø84,5
1,6 1581	4 CYL ø86,4 EXPERT 02/96-->	79 PS / 58 KW	222A2(1580SPI)	40304002 5890649 40304001	 40304005 0209.P9 1,80mm ø87

▲ : İçerikte Bulunmamaktadır...

▲ : Not included in the set

▲ : Non inclus dans la pochette

00: Motor Takım Keçesiz ve Subap Lastiksiz





























00: Gasket Set Without oil seals Without Valve Stem Seal

01: Motor Takım Keçesiz - Subap Lastikli

01: Gasket set With Valve Stem Seal Without Oil Seals

02: Motor Full Takım Keçeli ve Subap Lastikli

02: Gasket Full Set With oil seals and Valve Stem Seals

Subap Kapak Valve Cover Gasket Zylinderkopfhaube Couvre-culbut.	Karter Oil Pan Ölwanne Carter d'huile	Emme Manifold Intake Manifold Ansaug Admission	Egzoz Manifold Exhaust Manifold Auspuffkrümmer Collecteur D'echappement	Eksoz Boğaz Exhaust Pipe Auspuff Kehle	Supap Keçesi Valve Stem Seal Ventilschaft Queue de soupape	
						
 <b>41207525</b> 0249.48 91508054	 <b>41203013</b> 0304.34 93502226  <b>41203014</b> 93501565	 <b>41203018x2</b> 91508659.  <b>41207018</b> 951299280  <b>41207019</b> 0348.76	 <b>41207020x4</b> 0349.70 91505500  <b>41205019</b> 1721.01 7810024000	 <b>41207017</b> 1710.39 91511460	 <b>40107027x8</b> 0956.22 <b>8x10,8/14,2x10</b>	<b>21201062</b> 36x50x7 RD <b>21201019</b> 42x62x8 RD <b>21201040</b> 90x110x10 LD
 <b>41233025</b> 0249.71	 <b>41203013</b> 0304.34 93502226.	 <b>41233018x4</b> 0348.E6 + 0348F6	 <b>41233020x4</b> 1723.63		 <b>40107027x8</b> 0956.22 <b>8x10,8/14,2x10</b>	<b>21201062</b> 36x50x7 RD <b>21201019</b> 42x62x8 RD <b>21201040</b> 90x110x10 LD
 <b>40304034</b> 0249.83  <b>40304035</b> 0249.84	 <b>40304013</b> 0304.49	 <b>40304020</b> 7772495			 <b>40107027x8</b> 0956.22 <b>8x10,8/14,2x10</b>	<b>21201006x2</b> 30x52x7 RD <b>21201017</b> 40x56x7 RD <b>21201030</b> 64x80x8 LD

■ : Delik - Çentik

■ : Hole - Notch

■ : Trou - Entaille

NOT: Katalogdaki Orijinal Kodlar Referans Amacıyla Kullanılmıştır.Lütfen Oto Conta Kodlarını Kullanınız.  
Original codes used for reference only.Please use OTO CONTA codes for orders.



PEUGEOT

00



01



02



03



04



Silindir Kapak  
Cylinder Head  
Zylinderkopf  
Joint de culasse



Ltr	MODEL	PS/KW	ENGINE/MOTOR		
1,6 1587	4 CYL ø78,5 PARTNER 08/00--> PARTNER 16V 1007 16V 206 206 CC 16V 206 SW 16V 206 16V 207 307 307 CC 16V 307 SW 16V 307 16V 308	112 PS / 82 KW 106 PS / 78 KW	TU5JP4 (NFU) TU5JP4 (N6A)		 42200005 0209.1E MLS ø79,5
1,6 1618	4 CYL ø84 504 01/80-->06/87 J7 08/68-->03/80 J9 03/80-->06/87	60 PS / 44 KW 63 PS / 46 KW	XC7P	41210001 0197.L1	 41210005 0209.F8 ø86,7
1,8 1761	4 CYL ø83 306 05/93-->04/02 405 08/92-->10/96 406 05/97-->10/04 PARTNER 05/97--> EXPERT	101 PS / 74 KW 88 PS / 65 KW	XU7JP(LFZ) XU7JB(LFX)	41233002 0197.G4+0209.E1	 41207005 0209.E1 1,30mm 1 ■ 41207006 0209.L8 1,50mm 2 ■  42130005 0209.L3 1,50mm ø84,5

▲ : İçerikte Bulunmamaktadır...

▲ : Not included in the set

▲ : Non inclus dans la pochette

00: Motor Takım Keçesiz ve Subap Lastiksiz











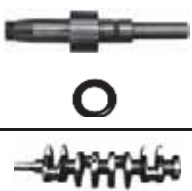







00: Gasket Set Without oil seals Without Valve Stem Seal

01: Motor Takım Keçesiz - Subap Lastikli

01: Gasket set With Valve Stem Seal Without Oil Seals

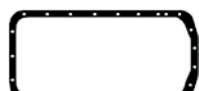
02: Motor Full Takım Keçeli ve Subap Lastikli

02: Gasket Full Set With oil seals and Valve Stem Seals

Subap Kapak Valve Cover Gasket Zylinderkopfhaube Couvre-culbut.	Karter Oil Pan Ölwanne Carter d'huile	Emme Manifold Intake Manifold Ansaug Admission	Egzoz Manifold Exhaust Manifold Auspuffkrümmer Collecteur D'echappement	Eksoz Boğaz Exhaust Pipe Auspuff Kehle	Supap Keçesi Valve Stem Seal Ventilschaft Queue de soupape	
						
 41210525 0249.14	 41210013 0304.44	 41211016 0348.33	 41210020 0349.03		 40107027x8 0956.22 8x10,8/14,2x10	
 41233025 0249.71	 41203013 0304.34 93502226.	 41233018x4 0348.E6 + 0348F6	 41233020x4 1723.63		 40107027x8 0956.22 8x10,8/14,2x10	21201062 36x50x7 RD  21201019 42x62x8 RD  21201040 90x110x10 LD

■ : Delik - Çentik

■ : Hole - Notch

■ : Trou - Entaille

NOT: Katalogdaki Orijinal Kodlar Referans Amacıyla Kullanılmıştır.Lütfen Oto Conta Kodlarını Kullanınız.  
Original codes used for reference only.Please use OTO CONTA codes for orders.



PEUGEOT

00



01



02



03

















04



Silindir Kapak  
Cylinder Head  
Zylinderkopf  
Joint de culasse



Ltr	MODEL	PS/KW	ENGINE/MOTOR		
1,8 1761	4 CYL ø83 306 16V 03/97-->04/02 406 16V 11/95-->10/00	110 PS / 81 KW	XU7JP4(LFY)		 42220005 0209.Q3 1,20mm 1  42220006 0209.V4 1,40mm 2  42220007 1,60mm 3  ø84
1,8 1769	4 CYL ø80 PARTNER D 11/82--> 205 D 305 D 306 306 D 309 D	60 PS / 44 KW 58 PS / 43 KW	XUD7 (A9A) XUD7 (161A) 161 (XUD7) 161A (XUD7)	41204002 0197.H5  41204003 0197.H4 	 41203009 0209.S0 1,36 mm. 1  41203008 0209.S1 1,40 mm. 2  41203007 0209.S2 1,44 mm. 3  41203006 0209.S3 1,48 mm. 4  41203005 0209.S4 1,53 mm. 5  ø82
1,8 1769	4 CYL ø80 205 10/87-->09/98 205 TD 309 TD 405 D 405 DT 405 TD	90 PS / 66 KW 78 PS / 57 KW	XUD7T XUD7TE (AJZ) XUD7TE (A8A) XUD7TE (A8B)	41204002 0197.H5  41204003 0197.H4 	

▲ : İçerikte Bulunmamaktadır...

▲ : Not included in the set

▲ : Non inclus dans la pochette

00: Motor Takım Keçesiz ve Subap Lastiksiz











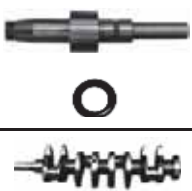





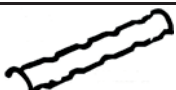



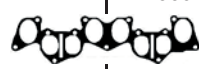

00: Gasket Set Without oil seals Without Valve Stem Seal

01: Motor Takım Keçesiz - Subap Lastikli

01: Gasket set With Valve Stem Seal Without Oil Seals

02: Motor Full Takım Keçeli ve Subap Lastikli

02: Gasket Full Set With oil seals and Valve Stem Seals

Subap Kapak Valve Cover Gasket Zylinderkopfhaube Couvre-culbut.	Karter Oil Pan Ölwanne Carter d'huile	Emme Manifold Intake Manifold Ansaug Admission	Egzoz Manifold Exhaust Manifold Auspuffkrümmer Collecteur D'echappement	Eksoz Boğaz Exhaust Pipe Auspuff Kehle	Supap Keçesi Valve Stem Seal Ventilschaft Queue de soupape	
						
 <b>41203525</b> 0249.46 0249.91	 <b>41203013</b> 0304.34   <b>41203014</b> 93501565	 <b>41203116x2</b> 0348.99   <b>41203018x2</b> 91508659   <b>41203021</b> 0348.JO	 <b>41205019</b> 1721.01 7810024000   <b>41203120x2</b> 0349.47 93010402		 <b>40107027x8</b> 0956.22 8x10,8/14,2x10	<b>21201011x2</b> 35x50x8 WD  <b>21201019</b> 42x62x8 RD  <b>21201040</b> 90x110x7 LD
 <b>41203525</b> 0249.46 0249.91	 <b>41203013</b> 0304.34   <b>41203014</b> 93501565	 <b>41203116x2</b> 0348.99   <b>41203018x2</b> 91508659   <b>41203021</b> 0348.JO	 <b>41205019</b> 1721.01 7810024000   <b>41203120x2</b> 0349.47 93010402		 <b>40107027x8</b> 0956.22 8x10,8/14,2x10	<b>21201011x2</b> 35x50x8 WD  <b>21201019</b> 42x62x8 RD  <b>21201040</b> 90x110x7 LD

■ : Delik - Çentik

■ : Hole - Notch

■ : Trou - Entaille

NOT: Katalogdaki Orijinal Kodlar Referans Amacıyla Kullanılmıştır.Lütfen Oto Conta Kodlarını Kullanınız.  
Original codes used for reference only.Please use OTO CONTA codes for orders.



PEUGEOT

00



01



02



03



04



Silindir Kapak  
Cylinder Head  
Zylinderkopf  
Joint de culasse



Ltr	MODEL	PS/KW	ENGINE/MOTOR		
1,8 1796	<b>4 CYL ø84</b> <b>504</b> 07/68-->12/89 <b>505</b> 06/81-->10/86 <b>J5</b> 01/83-->11/88 <b>J7</b> 07/70-->03/80	65 PS / 48 KW 69 PS / 51 KW 73 PS / 54 KW 82 PS / 60 KW 84 PS / 62 KW	105 (XM7) 169B(XM7T) XM XM7 XM7P	<b>41210001</b> 0197.L1 0197.15	 <b>41210005</b> 0209.F8 <b>ø86,7</b>
1,9 1868	<b>4 CYL ø82,2</b> <b>EXPERT D</b> 06/96--> <b>PARTNER D</b> <b>206 D</b> <b>306 D</b>	69 PS / 51 KW	DW8 (WJZ) DW8B (WJY)	<b>42173002</b> 0197.X6 	 <b>42173005</b> 0209.1C 1,47mm <b>42173006</b> 0209.X4 1,42mm 5 <b>42173007</b> 0209.X3 1,38mm 4 <b>42173008</b> 0209.X2 1,34mm 3 <b>42173009</b> 0209.X1 1,30mm 2 <b>42173010</b> 0209.X0 1,26mm 1 MLS <b>ø84</b>
1,9 1905	<b>4 CYL ø83</b> <b>205</b> 09/84-->07/89 <b>205 GTI</b> <b>305</b> <b>309</b> <b>309 GTI</b>	128 PS / 94 KW 98 PS / 72 KW	XU9JA (D6B) XU9J1 (DFZ) XU9S (D2B) XU9S (159)	<b>41207002</b> 0197.89+0209.E1 <b>41207003</b> 0197.H6+0209.E1 <b>42130002</b> 0197.89+0209.L3 <b>42130003</b> 0197.H6+0209.L3	 <b>41207005</b> 0209.E1 1,30mm 1 <b>41207006</b> 0209.L8 1,50mm 2  <b>42130005</b> 0209.L3 1,50mm <b>ø84,5</b>

▲ : İçerikte Bulunmamaktadır...

▲ : Not included in the set

▲ : Non inclus dans la pochette

00: Motor Takım Keçesiz ve Subap Lastiksiz











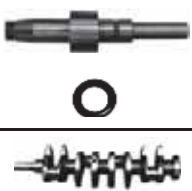







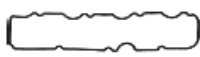

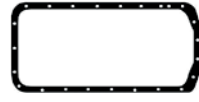

00: Gasket Set Without oil seals Without Valve Stem Seal

01: Motor Takım Keçesiz - Subap Lastikli

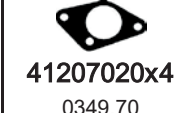
01: Gasket set With Valve Stem Seal Without Oil Seals

02: Motor Full Takım Keçeli ve Subap Lastikli

02: Gasket Full Set With oil seals and Valve Stem Seals

Subap Kapak Valve Cover Gasket Zylinderkopfhaube Couvre-culbut.	Karter Oil Pan Ölwanne Carter d'huile	Emme Manifold Intake Manifold Ansaug Admission	Egzoz Manifold Exhaust Manifold Auspuffkrümmer Collecteur D'echappement	Eksoz Boğaz Exhaust Pipe Auspuff Kehle	Supap Keçesi Valve Stem Seal Ventilschaft Queue de soupape	
						
41210525 0249.14	41210013 0304.44	41211016 0348.33	41210020 0349.03		40107027x8 0956.22 8x10,8/14,2x10	
						21208023 35x50x8 RD
42173025 0249.95	41203013 0304.34	42173018x2 0348.N2	42173021x2 0349.H7		40107027x8 0956.22 8x10,8/14,2x10	21201019 42x62x8 RD 21201040 90x110x10 LD
						21201062 36x50x7 RD
41207525 0249.48 91508054	41203013 0304.34 93502226 41203014 93501565	41203018x2 91508659.  41207018 951299280  41207019 0348.76	41207020x4 0349.70 91505500  41205019 1721.01 7810024000	41207017 1710.39 91511460	40107027x8 0956.22 8x10,8/14,2x10	21201019 42x62x8 RD 21201040 90x110x10 LD

■ : Delik - Çentik

■ : Hole - Notch

■ : Trou - Entaille

NOT: Katalogdaki Orijinal Kodlar Referans Amacıyla Kullanılmıştır.Lütfen Oto Conta Kodlarını Kullanınız.  
Original codes used for reference only.Please use OTO CONTA codes for orders.



PEUGEOT

00



01



02



03



04



Silindir Kapak  
Cylinder Head  
Zylinderkopf  
Joint de culasse



Ltr	MODEL	PS/KW	ENGINE/MOTOR		
1,9 1905	4 CYL ø83 205 06/87-->05/97 205 CTI 205 GTI 309 309 GTI 405 405 01/89-->12/92	121 PS / 89 KW 95 PS / 70 KW  122 PS / 90 KW	XU9JAZ (DKZ) XU9J1 (DFZ) XU9M (DDZ) XU92C (D2A) XU92C (D2C)  XU9J2 (D6A)	41207002 0197.89+0209.E1  41207003 0197.H6+0209.E1  42130002 0197.89+0209.L3  42130003 0197.H6+0209.L3	 41207005 0209.E1 1,30mm 1  41207006 0209.L8 1,50mm 2  42130005 0209.L3 1,50mm ø84,5
1,9 1905	4 CYL ø83 309 GTI 16V 405	158 PS / 116 KW 147 PS / 108 KW	XU9J4 (D6C) XU9J4Z (DFW)		 42130005 0209.L3 1,50mm ø84,5
1,9 1905	4 CYL ø83 J5 10/82-->05/01 J5 D PARTNER D 205 D 305 D 306 D 306 SLD 306 STD 309 D 405 D 305 D 10/82-->12/93 309 D 10/82-->12/93	69 PS / 51 KW 64 PS / 47 KW  64 PS / 47 KW 64 PS / 47 KW	XUD9 XUD9 (DJZ) XUD9 (162)  XUD9 (D9A) XUD9 (D9A)	41204002 0197.H5   41204003 0197.H4 	 41204009 0209.S5 1,36 mm 1 41204008 0209.S6 1,40 mm 2 41204007 0209.S7 1,44 mm 3 41204006 0209.S8 1,48 mm 4 41204005 0209.S9 1,53 mm 5 ø 84

▲ : İçerikte Bulunmamaktadır...

▲ : Not included in the set

▲ : Non inclus dans la pochette

00: Motor Takım Keçesiz ve Subap Lastiksiz



























00: Gasket Set Without oil seals Without Valve Stem Seal

01: Motor Takım Keçesiz - Subap Lastikli

01: Gasket set With Valve Stem Seal Without Oil Seals

02: Motor Full Takım Keçeli ve Subap Lastikli

02: Gasket Full Set With oil seals and Valve Stem Seals

Subap Kapak Valve Cover Gasket Zylinderkopfhaube Couvre-culbut.	Karter Oil Pan Ölwanne Carter d'huile	Emme Manifold Intake Manifold Ansaug Admission	Egzoz Manifold Exhaust Manifold Auspuffkrümmer Collecteur D'echappement	Eksoz Boğaz Exhaust Pipe Auspuff Kehle	Supap Keçesi Valve Stem Seal Ventilschaft Queue de soupape	
						
 <b>41207525</b> 0249.48 91508054	 <b>41203013</b> 0304.34 93502226  <b>41203014</b> 93501565	 <b>41203018x2</b> 91508659.  <b>41207018</b> 951299280  <b>41207019</b> 0348.76	 <b>41207020x4</b> 0349.70 91505500  <b>41205019</b> 1721.01 7810024000	 <b>41207017</b> 1710.39 91511460	 <b>40107027x8</b> 0956.22 8x10,8/14,2x10	<b>21201062</b> 36x50x7 RD <b>21201019</b> 42x62x8 RD <b>21201040</b> 90x110x10 LD
 <b>41203525</b> 0249.46 0249.91	 <b>41203013</b> 0304.34  <b>41203014</b> 93501565	 <b>41203116x2</b> 0348.99  <b>41203018x2</b> 91508659  <b>41203021</b> 0348.JO	 <b>41205019</b> 1721.01 7810024000  <b>41203120x2</b> 0349.47 93010402		 <b>40107027x8</b> 0956.22 8x10,8/14,2x10	<b>21201011x2</b> 35x50x8 WD <b>21201019</b> 42x62x8 RD <b>21201040</b> 90x110x7 LD

■ : Delik - Çentik

■ : Hole - Notch

■ : Trou - Entaille

NOT: Katalogdaki Orijinal Kodlar Referans Amacıyla Kullanılmıştır.Lütfen Oto Conta Kodlarını Kullanınız.  
Original codes used for reference only.Please use OTO CONTA codes for orders.



PEUGEOT

00



01



02



03













04



Silindir Kapak  
Cylinder Head  
Zylinderkopf  
Joint de culasse



Ltr	MODEL	PS/KW	ENGINE/MOTOR		
1,9 1905	4 CYL ø83 BOXER Bus D 03/88--> BOXER D EXPERT D J5 Bus D J5 D PARTNER D 306 D 306 SLD 405 D	70 PS / 51 KW 68 PS / 50 KW	XUD9A (DJY) XUD9A (D9B) XUD9AU (D8C)	41204002 0197.H5  41204003 0197.H4 	 41204009 0209.S5 1,36 mm 1  41204008 0209.S6 1,40 mm 2  41204007 0209.S7 1,44 mm 3  41204006 0209.S8 1,48 mm 4  41204005 0209.S9 1,53 mm 5  ø 84
1,9 1905	4 CYL ø83 BOXER 08/92--> BOXER Bus TD BOXER TD EXPERT DT EXPERT TD 306 D 306 DT 306 SRDT 306 TD 405 TD 406 D 406 TD 806 TD	94 PS / 69 KW 75 PS / 55 KW	XUD9BSD (DHV) XUD9SD (DHW) XUD9TE XUD9TE (DHX) XUD9TE (DHY) XUD9TE (D8B) XUD9UTF (D8C)	41204002 0197.H5  41204003 0197.H4 	
1,9 1948	4 CYL ø88 504 03/73-->12/89 J7 08/68-->07/78	55 PS / 40 KW	XDP88 XD4X88	41212002 0198.40	 41212005 0203.70 1,60mm 41212006 0209.L2 1,80mm ø94

▲ : İçerikte Bulunmamaktadır...

▲ : Not included in the set

▲ : Non inclus dans la pochette

00: Motor Takım Keçesiz ve Subap Lastiksiz



















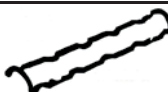













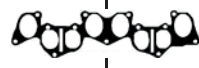

00: Gasket Set Without oil seals Without Valve Stem Seal

01: Motor Takım Keçesiz - Subap Lastikli

01: Gasket set With Valve Stem Seal Without Oil Seals

02: Motor Full Takım Keçeli ve Subap Lastikli

02: Gasket Full Set With oil seals and Valve Stem Seals

Subap Kapak Valve Cover Gasket Zylinderkopfhaube Couvre-culbut.	Karter Oil Pan Ölwanne Carter d'huile	Emme Manifold Intake Manifold Ansaug Admission	Egzoz Manifold Exhaust Manifold Auspuffkrümmer Collecteur D'echappement	Eksoz Boğaz Exhaust Pipe Auspuff Kehle	Supap Keçesi Valve Stem Seal Ventilschaft Queue de soupape	
						
 <b>41203525</b> 0249.46 0249.91	 <b>41203013</b> 0304.34  <b>41203014</b> 93501565	 <b>41203116x2</b> 0348.99  <b>41203018x2</b> 91508659  <b>41203021</b> 0348.JO	 <b>41205019</b> 1721.01 7810024000  <b>41203120x2</b> 0349.47 93010402		 <b>40107027x8</b> 0956.22 8x10,8/14,2x10	<b>21201011x2</b> 35x50x8 WD <b>21201019</b> 42x62x8 RD <b>21201040</b> 90x110x7 LD
 <b>41203525</b> 0249.46 0249.91	 <b>41203013</b> 0304.34  <b>41203014</b> 93501565	 <b>41203116x2</b> 0348.99  <b>41203018x2</b> 91508659  <b>41203021</b> 0348.JO	 <b>41205019</b> 1721.01 7810024000  <b>41203120x2</b> 0349.47 93010402		 <b>40107027x8</b> 0956.22 8x10,8/14,2x10	<b>21201011x2</b> 35x50x8 WD <b>21201019</b> 42x62x8 RD <b>21201040</b> 90x110x7 LD
 <b>41212525</b> 0249.25	 <b>41212014</b> 0313.19  <b>41212015</b> 0304.12	 <b>41212016x3</b> 0348.11	 <b>41212020x2</b> 0349.08	 <b>41205018</b> 1710.07  <b>41212018</b> 1710.15  <b>41212019</b> 1710.19		<b>21201020</b> 42x60x10 RD

■ : Delik - Çentik

■ : Hole - Notch

■ : Trou - Entaille

NOT: Katalogdaki Orijinal Kodlar Referans Amacıyla Kullanılmıştır.Lütfen Oto Conta Kodlarını Kullanınız.  
Original codes used for reference only.Please use OTO CONTA codes for orders.



## PEUGEOT

00



Silindir Kapak

Cylinder Head

01



Zylinderkopf

Joint de culasse

02



03



04



Ltr	MODEL	PS/KW	ENGINE/MOTOR		
2.0	4 CYL ø88				
1971	504	03/71-->07/86	97 PS / 71 KW	XN1	41211001
	505		92 PS / 68 KW	XN1 (106)	9400197139
	504	09/79--->08/82	94 PS / 69 KW	XN1	
	505	09/85-->09/91	98 PS / 72 KW	XN1A(106E)	
	J5	03/80-->08/90	79 PS / 58 KW	XN1P	
	J9		78 PS / 57 KW		
	J9 Bus				
	J5	09/87-->08/90	75 PS / 55 KW	XN1T	41211005
	J5 Bus	09/81-->	85 PS / 62 KW	XN1T (170)	0209.46
			75 PS / 55 KW	XN1T (170B)	1,20mm
				XN1TA (170C)	
	J5	09/90-->01/94	94 PS / 69 KW	XN1TA	41211006
			84 PS / 62 KW		0209.46
	504	01/71-->08/84	106 PS / 78 KW	XN2(107)	1,80mm
					ø90
2.0	4 CYL ø86				
1998	306 16V	03/97-->04/02	132 PS / 97 KW	XU10J4R (RFV)	412170005
	406 16V	11/95-->10/04			0209.N6
	605 16V	07/94-->09/99			1.35 mm 1
	806 16V	05/98-->09/00			412170006
					0209.T9
					1,50mm 2
					ø87

▲ : İçerikte Bulunmamaktadır...

▲ : Not included in the set

▲ : Non inclus dans la pochette

00: Motor Takım Keçesiz ve Subap Lastiksiz













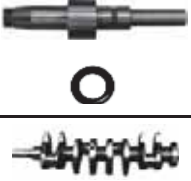

00: Gasket Set Without oil seals Without Valve Stem Seal

01: Motor Takım Keçesiz - Subap Lastikli

01: Gasket set With Valve Stem Seal Without Oil Seals

02: Motor Full Takım Keçeli ve Subap Lastikli

02: Gasket Full Set With oil seals and Valve Stem Seals

<p>Subap Kapak Valve Cover Gasket Zylinderkopfhaube Couvre-culbut.</p> 	<p>Karter Oil Pan Ölwanne Carter d'huile</p> 	<p>Emme Manifold Intake Manifold Ansaug Admission</p> 	<p>Egzoz Manifold Exhaust Manifold Auspuffkrümmer Collecteur D'echappement</p> 	<p>Eksoz Boğaz Exhaust Pipe Auspuff Kehle</p> 	<p>Supap Keçesi Valve Stem Seal Ventilschaft Queue de soupape</p> 	
 <p><b>41210525</b> 0249.14</p>	 <p><b>41210013</b> 0322.10 0304.11</p>	 <p><b>41211016</b> 0348.33</p>  <p><b>41211015</b> 0348.21</p>	 <p><b>41210020</b> 0349.03</p>	 <p><b>41205017</b> 1710.09</p>  <p><b>41212019</b> 1710.19</p>	 <p><b>40107027x8</b> 0956.22 <b>8x10,8/14,2x10</b></p>	

■ : Delik - Çentik

■ : Hole - Notch

■ : Trou - Entaille

NOT: Katalogdaki Orijinal Kodlar Referans Amacıyla Kullanılmıştır.Lütfen Oto Conta Kodlarını Kullanınız.  
Original codes used for reference only.Please use OTO CONTA codes for orders.



PEUGEOT

00



01



02



03



04



Silindir Kapak  
Cylinder Head  
Zylinderkopf  
Joint de culasse



Ltr	MODEL	PS/KW	ENGINE/MOTOR		
2,1 2112	<b>4 CYL ø90</b> J9 D 03/80-->06/87 J7 Bus D 08/98-->07/86 J7 D 504 D	56 PS / 41 KW 65 PS / 48 KW 57 PS / 42 KW	XDPX90 XDP90 XD4x90	<b>41212002</b> 0198.40	 <b>41212005</b> 0203.70 1,60mm <b>41212006</b> 0209.L2 1,80mm <b>ø94</b>
2,3 2304	<b>4 CYL ø94</b> 504 07/75-->12/89 J7 Bus D 07/77-->07/82 J7 D J9 Bus D J9 D 505 D 09/79-->06/86 505 TD 604 TD	69 PS / 51 KW 67 PS / 49 KW 80 PS / 59 KW	XD2(134) XD2PX94 XD2P94 XD2S (147)	<b>41218000</b> 0198.94 	 <b>41218005</b> 0209.C6 1,73mm 4 <b>M</b> <b>41218006</b> 0209.C4 1,63mm 3 <b>M</b> <b>41218007</b> 0209.C2 1,53mm 2 <b>M</b> <b>ø96</b>
2,5 2498	<b>4 CYL ø94</b> 505 D 06/81-->12/93 J9 Bus D 07/82-->06/87 J9 D 505 TD 08/83--> 604 TD	75 PS / 55 KW 69 PS / 51 KW 72 PS / 53 KW 105 PS / 74 KW 73 PS / 54 KW	XD3 (155) XD3P XD3T (152A) XD3TE XD3TE (152B)	<b>41218000</b> 0198.94 	 <b>41218005</b> 0209.C6 1,73mm 4 <b>M</b> <b>41218006</b> 0209.C4 1,63mm 3 <b>M</b> <b>41218007</b> 0209.C2 1,53mm 2 <b>M</b> <b>ø96</b>

▲ : İçerikte Bulunmamaktadır...

▲ : Not included in the set

▲ : Non inclus dans la pochette

00: Motor Takım Keçesiz ve Subap Lastiksiz



























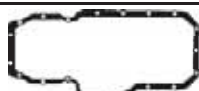

00: Gasket Set Without oil seals Without Valve Stem Seal

01: Motor Takım Keçesiz - Subap Lastikli

01: Gasket set With Valve Stem Seal Without Oil Seals

02: Motor Full Takım Keçeli ve Subap Lastikli

02: Gasket Full Set With oil seals and Valve Stem Seals

Subap Kapak Valve Cover Gasket Zylinderkopfhaube Couvre-culbut.	Karter Oil Pan Ölwanne Carter d'huile	Emme Manifold Intake Manifold Ansaug Admission	Egzoz Manifold Exhaust Manifold Auspuffkrümmer Collecteur D'echappement	Eksoz Boğaz Exhaust Pipe Auspuff Kehle	Supap Keçesi Valve Stem Seal Ventilschaft Queue de soupape	
						
 <b>41212525</b> 0249.25	 <b>41212014</b> 0313.19  <b>41212015</b> 0304.12	 <b>41212016x3</b> 0348.11	 <b>41212020x2</b> 0349.08	 <b>41205018</b> 1710.07  <b>41212018</b> 1710.15  <b>41212019</b> 1710.19		<b>21201020</b> 42x60x10 RD
 <b>41212525</b> 0249.25	 <b>41212014</b> 0313.19  <b>41212015</b> 0304.12	 <b>41212016x3</b> 0348.11	 <b>41212020x2</b> 0349.10	 <b>41212018</b> 1710.15  <b>41212019</b> 1710.19		
 <b>41212525</b> 0249.25	 <b>41212014</b> 0313.19  <b>41212015</b> 0304.12	 <b>41212016x3</b> 0348.11	 <b>41212020x2</b> 0349.10	 <b>41212018</b> 1710.15  <b>41212019</b> 1710.19		

■ : Delik - Çentik

■ : Hole - Notch

■ : Trou - Entaille

NOT: Katalogdaki Orijinal Kodlar Referans Amacıyla Kullanılmıştır.Lütfen Oto Conta Kodlarını Kullanınız.  
Original codes used for reference only.Please use OTO CONTA codes for orders.



PEUGEOT

00



01



02



03



04



Silindir Kapak  
Cylinder Head  
Zylinderkopf  
Joint de culasse



Ltr	MODEL	PS/KW	ENGINE/MOTOR		
2,5 2500	4 CYL ø93 J5 J5 Bus D J5 D J5 DT 09/81--> 09/81-->01/94	73 PS / 54 KW 95 PS / 70 KW	CRD93 CRD93L	41215003 0197.K1	 41215005 0209.L5 1,40mm ø95,5
2,5 2500	4 CYL ø93 J5 Bus TD J5 TD 10/90-->	95 PS / 70 KW	CRD93LS	41215103 0197.R9	 41215105 0209.L6 1,40mm ø95,5
2,7 2664	6 CYL ø88 604 504 604 08/77-->05/83 08/77-->08/84	136 PS / 100 KW 144 PS / 106 KW	ZM(112) ZMJ(140)		 0203.67 1,20mm  0203.66 1,20mm ø90 40115005
2,8 2799	4 CYL ø94,4 BOXER BOXER DTIC BOXER TD BOXER HDI BOXER BUS HDI 10/97-->03/05 10-00-->	122 PS / 90 KW 128 PS / 94 KW 126 PS / 93 KW	8140.43(F28DT) 8140.43S (F28DTCR)	40139100 71713696 	 40139005 0209.OF 1,50mm 40139006 0209.OE 1,40mm 40139007 0209.OC 1,30mm ø96

▲ : İçerikte Bulunmamaktadır...

▲ : Not included in the set

▲ : Non inclus dans la pochette

00: Motor Takım Keçesiz ve Subap Lastiksiz





















00: Gasket Set Without oil seals Without Valve Stem Seal

01: Motor Takım Keçesiz - Subap Lastikli

01: Gasket set With Valve Stem Seal Without Oil Seals

02: Motor Full Takım Keçeli ve Subap Lastikli

02: Gasket Full Set With oil seals and Valve Stem Seals

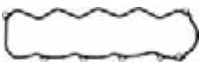
Subap Kapak Valve Cover Gasket Zylinderkopfhaube Couvre-culbut.	Karter Oil Pan Ölwanne Carter d'huile	Emme Manifold Intake Manifold Ansaug Admission	Egzoz Manifold Exhaust Manifold Auspuffkrümmer Collecteur D'echappement	Eksoz Boğaz Exhaust Pipe Auspuff Kehle	Supap Keçesi Valve Stem Seal Ventilschaft Queue de soupape	
						
 <b>41215025</b> 5 450 155		 <b>41215019x4</b> 0348.H0	 <b>41215021x4</b> 0349.F0	 <b>41215017</b> 95494600		
 <b>41215025</b> 5 450 155		 <b>41215019x4</b> 0348.H0	 <b>41215021x4</b> 0349.F0	 <b>41215017</b> 95494600		
 <b>40138045</b> 0249.A0	 <b>40138068</b> 500327440	 <b>40146019x4</b> 98425767	 <b>40147021x4</b> 98434020			
 <b>40138047</b> 0249.C3						

■ : Delik - Çentik

■ : Hole - Notch

■ : Trou - Entaille

NOT: Katalogdaki Orijinal Kodlar Referans Amacıyla Kullanılmıştır.Lütfen Oto Conta Kodlarını Kullanınız.  
Original codes used for reference only.Please use OTO CONTA codes for orders.



# PROTON

00

Silindir Kapak  
Cylinder Head

01



Zylinderkopf

02



Joint de culasse

03



04



Ltr	MODEL	PS/KW	ENGINE/MOTOR		
1,1 1124	4 CYL ø72 TIARA 1996-->	60 PS / 44 KW	TU1	41209002 Motor Full Takım Gasket Full Set 41209003 0197.H8+0209.CJ 41209004 0197.H9	 41209005 0209.CJ 1,30mm 1 41209006 0209.W6 - W7 1,50 mm 2 ø76
1,3 1298	4 CYL ø71 SAGA 1985-->	77 PS / 56 KW	4G13		 41507005 MD066163 1,40mm ø72,5
1,3 1298	4 CYL ø71 PERSONA 12V 01/94--> WIRA 12V ISWARA 12V SATRIA 12V	75 PS / 55 KW	4G13		 41415405 MD323473 1,40mm ø76,5
1,5 1468	4 CYL ø75,5 SAGA 1985-->	75 PS / 55 KW	4G15		 41500305 MD016163 1,40mm 41500306 MD016163 2,00mm ø76,5
1,5 1468	4 CYL ø75,5 PERSONA 12V 05/89-->08/99 WIRA 12V ISWARA 12V SATRIA 12V	90 PS / 66 KW 75 PS / 55 KW	4G15		 41415405 MD323473 1,40mm ø76,5

▲ : İçerikte Bulunmamaktadır...

▲ : Not included in the set

▲ : Non inclus dans la pochette

00: Motor Takım Keçesiz ve Subap Lastiksiz















00: Gasket Set Without oil seals Without Valve Stem Seal

01: Motor Takım Keçesiz - Subap Lastikli

01: Gasket set With Valve Stem Seal Without Oil Seals

02: Motor Full Takım Keçeli ve Subap Lastikli

02: Gasket Full Set With oil seals and Valve Stem Seals

Subap Kapak Valve Cover Gasket Zylinderkopfhaube Couvre-culbut.	Karter Oil Pan Ölwanne Carter d'huile	Emme Manifold Intake Manifold Ansaug Admission	Egzoz Manifold Exhaust Manifold Auspuffkrümmer Collecteur D'echappement	Eksoz Boğaz Exhaust Pipe Auspuff Kehle	Supap Keçesi Valve Stem Seal Ventilschaft Queue de soupape	
						
						<b>21201062</b> 36x50x7 RD
<b>41209025</b> 0249.54	<b>41209013</b> 0304.304	<b>41209019x2</b>	<b>41209020x2</b> 0349,A6	<b>41209017</b> 1709.15	<b>40116026x8</b> 0956.19 7x9,8/13.2x10	<b>21201021</b> 42x66x6 RD <b>21204504</b> 85x105x8 LD

■ : Delik - Çentik

■ : Hole - Notch

■ : Trou - Entaille

NOT: Katalogdaki Orijinal Kodlar Referans Amacıyla Kullanılmıştır.Lütfen Oto Conta Kodlarını Kullanınız.  
Original codes used for reference only.Please use OTO CONTA codes for orders.



# PROTON

00



Silindir Kapak  
Cylinder Head

01



Zylinderkopf

02



Joint de culasse

03



04



Ltr MODEL PS/KW ENGINE/MOTOR

1,6 4 CYL ø76,5

WAJA

1995-->2006

GEN-2

PERSONA



**41415605**

PW811553

1,20mm

FIBER / FIBRE

**ø77,5**

▲ : İçerikte Bulunmamaktadır...

▲ : Not included in the set

▲ : Non inclus dans la pochette

00: Motor Takım Keçesiz ve Subap Lastiksiz









00: Gasket Set Without oil seals Without Valve Stem Seal

01: Motor Takım Keçesiz - Subap Lastikli

01: Gasket set With Valve Stem Seal Without Oil Seals

02: Motor Full Takım Keçeli ve Subap Lastikli

02: Gasket Full Set With oil seals and Valve Stem Seals

<p>Subap Kapak Valve Cover Gasket Zylinderkopfhaube Couvre-culbut.</p> 	<p>Karter Oil Pan Ölwanne Carter d'huile</p> 	<p>Emme Manifold Intake Manifold Ansaug Admission</p> 	<p>Egzoz Manifold Exhaust Manifold Auspuffkrümmer Collecteur D'echappement</p> 	<p>Eksoz Boğaz Exhaust Pipe Auspuff Kehle</p> 	<p>Supap Keçesi Valve Stem Seal Ventilschaft Queue de soupape</p> 	  

■ : Delik - Çentik

■ : Hole - Notch

■ : Trou - Entaille

NOT: Katalogdaki Orijinal Kodlar Referans Amacıyla Kullanılmıştır.Lütfen Oto Conta Kodlarını Kullanınız.  
Original codes used for reference only.Please use OTO CONTA codes for orders.



RENAULT

00



Silindir Kapak  
Cylinder Head  
Zylinderkopf  
Joint de culasse

01



02



03



04



Ltr	MODEL	PS/KW	ENGINE/MOTOR		
0,75 747	4 CYL ø54,5 R 4 04/62-->	27 PS / 20 KW 20 PS / 15 KW	680 701 680 702	40106001 7701460365	 40106005 7700724333 1,20mm 40106006 7700724333 1,80mm ø59,7
0,85 845	4 CYL ø58 RODEO 4 10/62--> RODEO 6 4 5	37 PS / 27 KW 26 PS / 19 KW	B1B 707 800 800 01 800 02 800 05 800 705 800 710 839 839 06 839 07 839 701 839 706 839 707	40106001 7701460365	 40106005 7700724333 1,20mm 40106006 7700724333 1,80mm ø59,7
0,85 852	4 CYL ø61,4 R 4 01/76-->12/76 F 4	29 PS / 21 KW	813,02	40108002 77 01 459 391	 40108005 77 00 680 688 1,20mm 40108006 77 00 680 688 1,80mm ø72
1.0 956	4 CYL ø65 R 5 01/72-->12/85	44 PS / 32 KW	689 710	40108002 77 01 459 391	 40108005 77 00 680 688 1,20mm 40108006 77 00 680 688 1,80mm ø72

▲ : İçerikte Bulunmamaktadır...

▲ : Not included in the set

▲ : Non inclus dans la pochette

00: Motor Takım Keçesiz ve Subap Lastiksiz











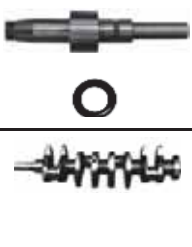





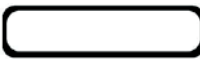

00: Gasket Set Without oil seals Without Valve Stem Seal

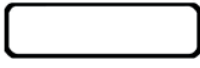
01: Motor Takım Keçesiz - Subap Lastikli

01: Gasket set With Valve Stem Seal Without Oil Seals

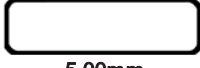
02: Motor Full Takım Keçeli ve Subap Lastikli

02: Gasket Full Set With oil seals and Valve Stem Seals

Subap Kapak Valve Cover Gasket Zylinderkopfhaube Couvre-culbut.	Karter Oil Pan Ölwanne Carter d'huile	Emme Manifold Intake Manifold Ansaug Admission	Egzoz Manifold Exhaust Manifold Auspuffkrümmer Collecteur D'echappement	Eksoz Boğaz Exhaust Pipe Auspuff Kehle	Supap Keçesi Valve Stem Seal Ventilschaft Queue de soupape	
						
<b>40106034</b> 05 55 565 700	<b>40106265</b> 980656900	<b>40106020 (x2)</b> 77 00 522 372				
						
<b>40106034</b> 05 55 565 700	<b>40106265</b> 980656900	<b>40106020 (x2)</b> 77 00 522 372				
						<b>21208003</b> 30x42x7 RD
<b>5,00mm</b> <b>40101525</b> 77 00 723 967	<b>40101265</b> 77 01 453 950	<b>40101020</b> 77 00 559 702				<b>21201034</b> 80x100x13 LD
						<b>21208003</b> 30x42x7 RD
<b>5,00mm</b> <b>40101525</b> 77 00 723 967	<b>40101265</b> 77 01 453 950	<b>40101020</b> 77 00 559 702				<b>21201034</b> 80x100x13 LD

■ : Delik - Çentik

■ : Hole - Notch

■ : Trou - Entaille

NOT: Katalogdaki Orijinal Kodlar Referans Amacıyla Kullanılmıştır.Lütfen Oto Conta Kodlarını Kullanınız.  
Original codes used for reference only.Please use OTO CONTA codes for orders.



RENAULT

00



Silindir Kapak  
Cylinder Head

01



Zylinderkopf

02



Joint de culasse

03



04



Ltr	MODEL	PS/KW	ENGINE/MOTOR		
1,0 956	4 CYL ø65 SUPER 5 RAPID SUPERCINGO EXPRESS 10/84-->	42 PS / 31 KW 33 PS / 24 KW	C1C C1C 700 C1C 706 C1C 708 C1C 754	40157002 77 01 462 215 77 01 465 261	 40108005 77 00 680 688 1,20mm 40108006 77 00 680 688 1,80mm ø72
1,0 998	4 CYL ø69 LOGAN FLEX 16V ( DOCH ) 2007-->	75 PS / 55 KW 78 PS / 58 KW	D4DHIFLEX	40108703 77 01 475 822	 40108605 8200062273 MLS ø70
1,0 999	4 CYL ø69 CLIO KANGOO TWINGO 1999-->	59 PS / 43 KW	D7D		 40108805 77 00 864 736 1,40mm ø70,2
1,0 999	4 CYL ø69 CLIO 16V KANGOO 16V ( DOCH ) 2000--> 2003-->	60 PS / 44 KW	D4D 700 D4D 720	40108603 77 01 473 003	 40108605 8200062273 MLS ø70
1,1 1108	4 CYL ø70 R 8 R 10 05/66-->10/72	45 PS / 33 KW	689		 40108005 77 00 680 688 1,20mm 40108006 77 00 680 688 1,80mm ø72

▲ : İçerikte Bulunmamaktadır...

▲ : Not included in the set

▲ : Non inclus dans la pochette

00: Motor Takım Keçesiz ve Subap Lastiksiz











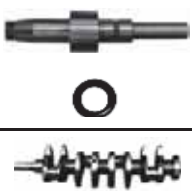









00: Gasket Set Without oil seals Without Valve Stem Seal

01: Motor Takım Keçesiz - Subap Lastikli

01: Gasket set With Valve Stem Seal Without Oil Seals

02: Motor Full Takım Keçeli ve Subap Lastikli

02: Gasket Full Set With oil seals and Valve Stem Seals

Subap Kapak Valve Cover Gasket Zylinderkopfhaube Couvre-culbut.	Karter Oil Pan Ölwanne Carter d'huile	Emme Manifold Intake Manifold Ansaug Admission	Egzoz Manifold Exhaust Manifold Auspuffkrümmer Collecteur D'echappement	Eksoz Boğaz Exhaust Pipe Auspuff Kehle	Supap Keçesi Valve Stem Seal Ventilschaft Queue de soupape	
						
 6,5mm <b>40102525</b> 77 01 348 574	 <b>40102268x4</b> 77 00 564 813	 <b>40103020</b> 77 00 855 962			 <b>40116026x8</b> 77 00 736 465 7x9,8/13.2x10	<b>21208067</b> 35x50x10 RD <b>21201034</b> 80x100x13 LD
 <b>40108725</b> 77 01 059 314		 <b>40108618</b> 77 01 473 007	 <b>40108621</b> 77 00 115 971		 <b>40108726x16</b> 82 00 171 215 5,5x8,3x11,5x8	<b>21204701</b> 28x47x8 RD
 <b>40108625</b> 77 01 049 888		 <b>40108618</b> 77 01 473 007	 <b>40108621</b> 77 00 115 971		 <b>40108626x16</b> 5,5x11x23x15,7	<b>21204701</b> 28x47x8 RD

■ : Delik - Çentik

■ : Hole - Notch

■ : Trou - Entaille

NOT: Katalogdaki Orijinal Kodlar Referans Amacıyla Kullanılmıştır.Lütfen Oto Conta Kodlarını Kullanınız.  
Original codes used for reference only.Please use OTO CONTA codes for orders.



RENAULT

00



Silindir Kapak  
Cylinder Head

01



Zylinderkopf

02



Joint de culasse

03



04



Ltr	MODEL	PS/KW	ENGINE/MOTOR		
1,1 1108	4 CYL ø70 RODEO 5 08/70--> RODEO 6 R 4 R 5 R 6	56 PS / 41 KW 34 PS / 25 KW	688 688 02 688 711 688 712 688 713 688.10 C1E / 688 C1E 714 C1E 718 C1E 719	<b>40108002</b> 77 01 459 391	 <b>40108005</b> 77 00 680 688 1,20mm <b>40108006</b> 77 00 680 688 1,80mm <b>ø72</b>
1,2 1149	4 CYL ø69 CLIO 16V 2000--> KANGOO 16V SANDERO 16V 2009--> ( DOCH )	75 PS / 55 KW	D4D 700 D4D 712 D4D	<b>40108603</b> 77 01 473 003	 <b>40108605</b> 8200062273 <b>MLS</b> <b>ø70</b>

▲ : İçerikte Bulunmamaktadır...

▲ : Not included in the set

▲ : Non inclus dans la pochette

00: Motor Takım Keçesiz ve Subap Lastiksiz











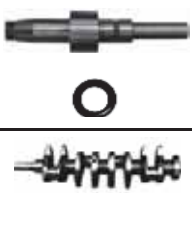





00: Gasket Set Without oil seals Without Valve Stem Seal

01: Motor Takım Keçesiz - Subap Lastikli

01: Gasket set With Valve Stem Seal Without Oil Seals

02: Motor Full Takım Keçeli ve Subap Lastikli

02: Gasket Full Set With oil seals and Valve Stem Seals

Subap Kapak Valve Cover Gasket Zylinderkopfhaube Couvre-culbut.	Karter Oil Pan Ölwanne Carter d'huile	Emme Manifold Intake Manifold Ansaug Admission	Egzoz Manifold Exhaust Manifold Auspuffkrümmer Collecteur D'echappement	Eksoz Boğaz Exhaust Pipe Auspuff Kehle	Supap Keçesi Valve Stem Seal Ventilschaft Queue de soupape	
						
 5,00mm <b>40101525</b> 77 00 723 967	 <b>40101265</b> 77 01 453 950	 <b>40101020</b> 77 00 559 702				<b>21208003</b> 30x42x7 RD
						<b>21201034</b> 80x100x13 LD
 <b>40108625</b> 77 01 049 888		 <b>40108618</b> 77 01 473 007	 <b>40108621</b> 77 00 115 971		 <b>40108626x16</b> 5,5x11x23x15,7	<b>21204701</b> 28x47x8 RD

■ : Delik - Çentik

■ : Hole - Notch

■ : Trou - Entaille

NOT: Katalogdaki Orijinal Kodlar Referans Amacıyla Kullanılmıştır.Lütfen Oto Conta Kodlarını Kullanınız.  
Original codes used for reference only.Please use OTO CONTA codes for orders.



RENAULT

00



01



02



03



04



Silindir Kapak  
Cylinder Head  
Zylinderkopf  
Joint de culasse



Ltr	MODEL	PS/KW	ENGINE/MOTOR		
1,1 1108	4 CYL ø70 CLIO RAPID SUPER 5 11 19 9	09/81-->09/98 49 PS / 36 KW 45 PS / 33 KW	C1E 700 C1E 715 C1E 720 C1E 750 C1E 752 C1E 754 C1E 756 C1E 760 C1E 762 C1E 792	40157002 77 01 462 215 77 01 465 261	 40108005 77 00 680 688 1,20mm 40108006 77 00 680 688 1,80mm ø72
1,2 1149	4 CYL ø69 TWINGO 16V CLIO 16V KANGOO 16V THALIA	01/01--> 75 PS / 55 KW 06/01--> 75 PS / 55 KW	D4F 702 D4F 704 D4F 706 D4F 712 D4F 714 D4F 716	40108603 77 01 473 003	 40108605 8200062273 MLS ø70
1,2 1149	4 CYL ø69 CLIO CLIO 16V MODUS MODUS 16V TWINGO TWINGO 16V	08/04--> 76 PS / 56 KW 60 PS / 44 KW	D4F 708 D4F 722 D4F 728 D4F 730 D4F 740 D4F 772	40108703 77 01 475 822	 40108605 8200062273 MLS ø70
1,2 1149	4 CYL ø69 CLIO CLIO 16V MODUS	12/04--> 78 PS / 58 KW 78 PS / 57 KW	D4F 764	40108503 77 01 476 731	 40108605 8200062273 MLS ø70
1,2 1149	4 CYL ø69 CLIO KANGOO THALIA TWINGO	01/96--> 60 PS / 44 KW 54 PS / 40 KW	D7D 760 D7F 700 D7F 701 D7F 702 D7F 703 D7F 704 D7F 706 D7F 710 D7F 720 D7F 722 D7F 726 D7F 730 D7F 744 D7F 746		 40108805 77 00 864 736 1,40mm ø70,2

▲ : İçerikte Bulunmamaktadır...

▲ : Not included in the set

▲ : Non inclus dans la pochette

00: Motor Takım Keçesiz ve Subap Lastiksiz











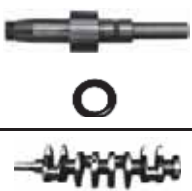













00: Gasket Set Without oil seals Without Valve Stem Seal

01: Motor Takım Keçesiz - Subap Lastikli

01: Gasket set With Valve Stem Seal Without Oil Seals

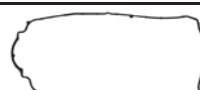
02: Motor Full Takım Keçeli ve Subap Lastikli

02: Gasket Full Set With oil seals and Valve Stem Seals

Subap Kapak Valve Cover Gasket Zylinderkopfhaube Couvre-culbut.	Karter Oil Pan Ölwanne Carter d'huile	Emme Manifold Intake Manifold Ansaug Admission	Egzoz Manifold Exhaust Manifold Auspuffkrümmer Collecteur D'echappement	Eksoz Boğaz Exhaust Pipe Auspuff Kehle	Supap Keçesi Valve Stem Seal Ventilschaft Queue de soupape	
						
 6,5mm <b>40102525</b> 77 01 348 574	 <b>40102268x4</b> 77 00 564 813	 <b>40103020</b> 77 00 855 962			 <b>40116026x8</b> 77 00 736 465 7x9,8/13.2x10	<b>21208067</b> 35x50x10 RD  <b>21201034</b> 80x100x13 LD
 <b>40108625</b> 77 01 049 888		 <b>40108618</b> 77 01 473 007	 <b>40108621</b> 77 00 115 971		 <b>40108626x16</b> 5,5x11x23x15,7	<b>21204701</b> 28x47x8 RD
 <b>40108725</b> 77 01 059 314		 <b>40108618</b> 77 01 473 007	 <b>40108621</b> 77 00 115 971		 <b>40108726x16</b> 82 00 171 215 5,5x8,3x11,5x8	<b>21204701</b> 28x47x8 RD
 <b>40108725</b> 77 01 059 314		 <b>40108618</b> 77 01 473 007	 <b>40108621</b> 77 00 115 971		 <b>40108726x16</b> 82 00 171 215 5,5x8,3x11,5x8	<b>21204025</b> 35x47x7 RD

 : Delik - Çentik

 : Hole - Notch

 : Trou - Entaille

NOT: Katalogdaki Orijinal Kodlar Referans Amacıyla Kullanılmıştır.Lütfen Oto Conta Kodlarını Kullanınız.  
Original codes used for reference only.Please use OTO CONTA codes for orders.



RENAULT

00



01



02



03



04



Silindir Kapak  
Cylinder Head  
Zylinderkopf  
Joint de culasse



Ltr	MODEL	PS/KW	ENGINE/MOTOR		
1,2 1149	4 CYL ø69 KANGOO TWINGO 07/98-->07/01 03/07-->	60 PS / 44 KW 58 PS / 43 KW	D7F 764 D7F 800		 <b>40108805</b> 77 00 864 736 1,40mm ø70,2
1,2 1171	4 CYL ø75,8 CLIO RAPID 05/90-->	65 PS / 44 KW 54 PS / 40 KW	E5F 710 E5F 716 E7F 700 E7F 704 E7F 706 E7F 708 E7F 730 E7F 750	<b>40116002</b> Motor Full Takım Gasket Full Set <b>40116003</b> 77 01 468 142 <b>40116004</b> Alt Takım Conversion Set	 <b>40116005</b> 77 00 273 786 1,40mm <b>40116009</b> 77 00 739 302 1,80mm ø77
1,2 1237	4 CYL ø71,5 RAPID SUPER 5 11 19 9 10/84-->12/96	60 PS / 44 KW 54 PS / 40 KW	C1G C1G 700 C1G 702 C1G 710 C1G 720 C1G 722 C1G 726 C1G 730	<b>▲ 40103001</b> Motor Takım Gasket Set <b>40103002</b> Motor Full Takım Gasket Full Set <b>40103003</b> 77 01 462 216	 <b>40102005</b> 77 00 680 689 1,20mm <b>40102006</b> 77 00 680 689 1,40mm <b>40102009</b> 77 00 680 689 1,80mm ø77
1,3 1289	4 CYL ø73 12 12 TS ESTAFETTE RODEO 5 5 08/69-->	68 PS / 49 KW 39 PS / 29 KW	810 01 810 02 810 2/97 810 06 810 719 810 725 810 726 810 729 810 96 810 97	<b>▲ 40101001</b> Motor Takım Gasket Set <b>40101002</b> 77 01 452 153	 <b>40101005</b> 77 00 576 242 1,20mm <b>40101009</b> 77 00 576 242 1,80mm ø74,3

▲ : İçerikte Bulunmamaktadır...

▲ : Not included in the set

▲ : Non inclus dans la pochette

00: Motor Takım Keçesiz ve Subap Lastiksiz



















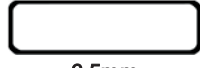

00: Gasket Set Without oil seals Without Valve Stem Seal

01: Motor Takım Keçesiz - Subap Lastikli

01: Gasket set With Valve Stem Seal Without Oil Seals

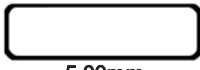
02: Motor Full Takım Keçeli ve Subap Lastikli

02: Gasket Full Set With oil seals and Valve Stem Seals

Subap Kapak Valve Cover Gasket Zylinderkopfhaube Couvre-culbut.	Karter Oil Pan Ölwanne Carter d'huile	Emme Manifold Intake Manifold Ansaug Admission	Egzoz Manifold Exhaust Manifold Auspuffkrümmer Collecteur D'echappement	Eksoz Boğaz Exhaust Pipe Auspuff Kehle	Supap Keçesi Valve Stem Seal Ventilschaft Queue de soupape	
						
 <b>40116527</b> 77 00 739 165	 <b>40116265</b> 77 00 739 392	 <b>40116021</b> 77 00 746 591	 <b>40116020</b> 77 00 854 041		 <b>40116026x8</b> 77 00 736 465 <b>7x9,8/13.2x10</b>	<b>21204004</b> 30x42x7 RD
						<b>21208001</b> 35x47x7 RD
						<b>21208012</b> 80x100x8 LD
 6,5mm <b>40102525</b> 77 01 348 574	 <b>40102265</b> 77 01 457 561	 <b>40103020</b> 77 00 855 962			 <b>▲ 40103027x8</b> 77 00 658 325 <b>7x10,8x13x9,8</b>	<b>▲ 21208067</b> 35x50x10 RD
						<b>▲ 21201034</b> 80x100x13 LD
 5,00mm <b>40101525</b> 77 00 723 967	 <b>40101265</b> 77 01 453 950	 <b>40101020</b> 77 00 559 702		 <b>40101017</b> 77 00 502 706	<b>▲</b>	<b>21201011</b> 35x50x8 RD
						<b>21201031</b> 70x90x10 LD

■ : Delik - Çentik

■ : Hole - Notch

■ : Trou - Entaille

NOT: Katalogdaki Orijinal Kodlar Referans Amacıyla Kullanılmıştır.Lütfen Oto Conta Kodlarını Kullanınız.  
Original codes used for reference only.Please use OTO CONTA codes for orders.



RENAULT

00



Silindir Kapak  
Cylinder Head  
Zylinderkopf  
Joint de culasse

01



02



03



04



Ltr MODEL PS/KW ENGINE/MOTOR

Ltr	MODEL	PS/KW	ENGINE/MOTOR		
1,3 1289	4 CYL ø73 R 5 R 5 Automatic RODEO 09/75-->09/84	64 PS / 47 KW 54 PS / 40 KW 45 PS / 33 KW	810 810.19 810 719 810 725 810 729	40123002 77 01 457 752	 40101005 77 00 576 242 1,20mm 40101006 77 00 576 242 1,80mm ø74,3
1,4 1390	4 CYL ø75,8 CLIO RAPID 19 01/88-->	80 PS / 59 KW 58 PS / 43 KW	E6J 700 E6J 701 E6J 706 E6J 712 E6J 713 E6J 718 E6J 734 E6J 738 E6J 760 E7J 601 E7J 700 E7J 706 E7J 710 E7J 711 E7J 718 E7J 719 E7J 720 E7J 724 E7J 726 E7J 728 E7J 742 E7J 745 E7J 754 E7J 756 E7J 757 E7J 773	40116002 Motor Full Takım Gasket Full Set 40116003 77 01 468 142 40116004 Alt Takım Conversion Set	 40116005 77 00 273 786 1,40mm 40116006 77 00 739 302 1,80mm ø77

▲ : İçerikte Bulunmamaktadır...

▲ : Not included in the set

▲ : Non inclus dans la pochette

00: Motor Takım Keçesiz ve Subap Lastiksiz











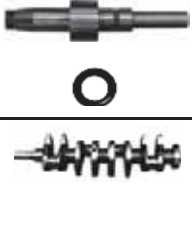





00: Gasket Set Without oil seals Without Valve Stem Seal

01: Motor Takım Keçesiz - Subap Lastikli

01: Gasket set With Valve Stem Seal Without Oil Seals

02: Motor Full Takım Keçeli ve Subap Lastikli

02: Gasket Full Set With oil seals and Valve Stem Seals

Subap Kapak Valve Cover Gasket Zylinderkopfhaube Couvre-culbut.	Karter Oil Pan Ölwanne Carter d'huile	Emme Manifold Intake Manifold Ansaug Admission	Egzoz Manifold Exhaust Manifold Auspuffkrümmer Collecteur D'echappement	Eksoz Boğaz Exhaust Pipe Auspuff Kehle	Supap Keçesi Valve Stem Seal Ventilschaft Queue de soupape	
						
 5,00mm <b>40101525</b> 77 00 723 967	 <b>40102265</b> 77 01 457 561	 <b>40101020</b> 77 00 559 702				<b>21204004</b> 30x42x7 RD  <b>21201031</b> 70x90x10 LD
 <b>40116527</b> 77 00 739 165	 <b>40116265</b> 77 00 739 392	 <b>40116021</b> 77 00 746 591	 <b>40116020</b> 77 00 746 591		 <b>40116026x8</b> 77 00 736 465 <b>7x9,8/13.2x10</b>	<b>21204004</b> 30x42x7 RD  <b>21208001</b> 35x47x7 RD  <b>21208012</b> 80x100x8 LD

■ : Delik - Çentik

■ : Hole - Notch

■ : Trou - Entaille

NOT: Katalogdaki Orijinal Kodlar Referans Amacıyla Kullanılmıştır.Lütfen Oto Conta Kodlarını Kullanınız.  
Original codes used for reference only.Please use OTO CONTA codes for orders.



RENAULT

00



01



02



03



04



Silindir Kapak  
Cylinder Head  
Zylinderkopf  
Joint de culasse



Ltr	MODEL	PS/KW	ENGINE/MOTOR		
1,4 1390	4 CYL ø75,8 CLIO 03/98--> CLIO 10/98-->05/05 KANGOO 09/97--> MEGANE 03/99--> MEGANE 11/95-->06/97 SCENIC 11/95-->06/97	75 PS / 55 KW 75 PS / 55 KW 75 PS / 55 KW 75 PS / 55 KW 75 PS / 55 KW 75 PS / 55 KW	E7J 780 E7J 635 - E7J 635 E7J 634 - E7J 780 E7J 626 - E7J 634 E7J 624 - E7J 764 E7J 624 - E7J 764	40116102 Motor Full Takım Gasket Full Set  40116103 77 01 468 709  40116104 Alt Takım Conversion Set	 40116005 77 00 273 786 1,40mm  40116009 77 00 739 302 1,80mm ø77
1,4 1390	4 CYL ø79,5 CLIO 16V 03/99--> MEGANE 16V MEGANE Grandtour 16V MODUS SCÉNIC 16V THALIA 16V  MEGANE 11/02--> MEGANE 16V SCÉNIC	98 PS / 72 KW 95 PS / 70 KW  98 PS / 72 KW 82 PS / 60 KW	K4J K4J 700 K4J 710 K4J 711 K4J 712 K4J 713 K4J 714 K4J 715 K4J 750 K4J 770 K4J 780 K4J 730 K4J 732 K4J 740	42457202 Motor Full Takım Gasket Full Set  42457203 77 01 471 886  42457204 Alt Takım Conversion Set	 42457205 77 00 112 739 MLS ø80,5
1,4 1390	4 CYL ø79,5 SCENIC16V 06/03--> MEGANE 16V 08/03--> MODUS 16V 06/05--> CLIO 16V 06/05-->	98 PS / 72 KW	K4J 740 K7J 780	42456502 Motor Takım Gasket Full Set  42457203 77 01 471 886  42457404 Alt Takım Conversion Set	 42457205 77 00 112 739 MLS ø80,5

▲ : İçerikte Bulunmamaktadır...

▲ : Not included in the set

▲ : Non inclus dans la pochette

00: Motor Takım Keçesiz ve Subap Lastiksiz











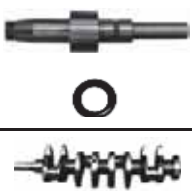















00: Gasket Set Without oil seals Without Valve Stem Seal

01: Motor Takım Keçesiz - Subap Lastikli

01: Gasket set With Valve Stem Seal Without Oil Seals

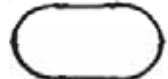
02: Motor Full Takım Keçeli ve Subap Lastikli

02: Gasket Full Set With oil seals and Valve Stem Seals

Subap Kapak Valve Cover Gasket Zylinderkopfhaube Couvre-culbut.	Karter Oil Pan Ölwanne Carter d'huile	Emme Manifold Intake Manifold Ansaug Admission	Egzoz Manifold Exhaust Manifold Auspuffkrümmer Collecteur D'echappement	Eksoz Boğaz Exhaust Pipe Auspuff Kehle	Supap Keçesi Valve Stem Seal Ventilschaft Queue de soupape	
						
 <b>40116527</b> 77 00 739 165	 ø7 <b>40116165</b>	 <b>40108918x4</b> 77 01 471 932  <b>40149018x4</b> 77 01 471 816  <b>40116019</b> 77 00 273 827  <b>40116021</b> 77 00 746 591	 <b>40149020</b> 77 00 867 360		 <b>40116026x8</b> 77 00 736 465 7x9,8/13.2x10	<b>21204004</b> 30x42x7 RD <b>21208001</b> 35x47x7 RD <b>21208012</b> 80x100x8 LD
	 <b>42457265</b> 77 00 103 687	 <b>42457218x4</b> 82 00 052 312  <b>42457219</b> 77 00 105 852	 <b>42457221</b> 77 00 107 181		 <b>42457244x16</b> 77 00 103 938 5,5x11x28x16,4	<b>21204024x2</b> 28x42x5 RD <b>21204005</b> 35x47x7 RD <b>21204009</b> 80x100x8 LD
	 <b>42457065</b> 82 00 379 654	 <b>42457218x4</b> 82 00 052 312  <b>42457219</b> 77 00 105 852	 <b>42457221</b> 77 00 107 181		 <b>42457244x16</b> 77 00 103 938 5,5x11x28x16,4	<b>21204024x2</b> 28x42x5 RD <b>21204005</b> 35x47x7 RD <b>21204009</b> 80x100x8 LD

■ : Delik - Çentik

■ : Hole - Notch

■ : Trou - Entaille

NOT: Katalogdaki Orijinal Kodlar Referans Amacıyla Kullanılmıştır.Lütfen Oto Conta Kodlarını Kullanınız.  
Original codes used for reference only.Please use OTO CONTA codes for orders.



RENAULT

00



01



02



03



04



Silindir Kapak  
Cylinder Head  
Zylinderkopf  
Joint de culasse



Ltr	MODEL	PS/KW	ENGINE/MOTOR		
1,4 1390	4 CYL ø79,5 LOGAN 09/04-->	75 PS / 55 KW	K7J 710	<b>40108902</b> Motor Full Takım Gasket Full Set  <b>40108903</b> 60 01 548 043  <b>40149004</b> Motor Alt Takım Conversion Set	 <b>40108905</b> 82 00 296 969 1,20mm FIBER / FIBRE <b>40108906</b> 82 00 296 969 MLS ø80,5
1,4 1390	4 CYL ø79,5 SYMBOL THALIA 08/08--> CLIO 08/97--> KANGOO	75 PS / 55 KW 75 PS / 55 KW	K7J 700 K7J 700 K7J 700 K7J 701	<b>40149002</b> Motor Full Takım Gasket Full Set  <b>40149003</b> 77 01 468 710  <b>40149004</b> Alt Takım Conversion Set	 <b>40149005</b> 77 00 866 683 1,40mm  <b>40149006</b> 77 00 866 683 1,60mm ø80
1,4 1397	4 CYL ø76 R 12 TS 01/76-->12/80 R 5 TX	63 PS / 46 KW 59 PS / 43 KW	847.05 847.06 847.07	<b>40102002</b> 77 01 458 695  ▲ <b>40102001</b> 77 01 458 695  <b>40102003</b> 77 01 458 694	 <b>40102005</b> 77 00 680 689 1,20mm  <b>40102006</b> 77 00 680 689 1,40mm  <b>40102009</b> 77 00 680 689 1,80mm ø77

▲ : İçerikte Bulunmamaktadır...

▲ : Not included in the set

▲ : Non inclus dans la pochette

00: Motor Takım Keçesiz ve Subap Lastiksiz



















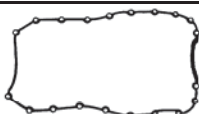

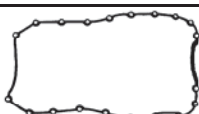

00: Gasket Set Without oil seals Without Valve Stem Seal

01: Motor Takım Keçesiz - Subap Lastikli

01: Gasket set With Valve Stem Seal Without Oil Seals

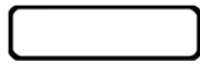
02: Motor Full Takım Keçeli ve Subap Lastikli

02: Gasket Full Set With oil seals and Valve Stem Seals

Subap Kapak Valve Cover Gasket Zylinderkopfhaube Couvre-culbut.	Karter Oil Pan Ölwanne Carter d'huile	Emme Manifold Intake Manifold Ansaug Admission	Egzoz Manifold Exhaust Manifold Auspuffkrümmer Collecteur D'echappement	Eksoz Boğaz Exhaust Pipe Auspuff Kehle	Supap Keçesi Valve Stem Seal Ventilschaft Queue de soupape	
						
						<b>21208003</b> 30x42x7 RD
<b>40116527</b> 77 01 471 719	<b>42457165</b> 77 00 273 486	<b>40108918x4</b> 77 01 471 932	<b>40108921</b> 8200191371		<b>40116026x8</b> 77 00 103 872 7x9,8/13.2x10	<b>21208001</b> 35x47x7 RD
						<b>21208003</b> 30x42x7 RD
<b>40116527</b> 77 01 471 719	<b>42457165</b> 77 00 273 486	<b>40108918x4</b> 77 01 471 932	<b>40149020</b> 77 00 867 360		<b>40116026x8</b> 77 00 103 872 7x9,8/13.2x10	<b>21208001</b> 35x47x7 RD
						<b>21208012</b> 80x100x8 LD
		<b>40149018x4</b> 77 01 471 816				
						
		<b>40149019</b> 77 00 865 764				
						<b>▲21201011</b> 35x50x8 RD
<b>6,5mm</b> <b>40102525</b> 77 01 348 574	<b>40102265</b> 77 01 457 561	<b>40101020</b> 77 00 559 702	<b>40101017</b> 77 00 502 706			<b>▲21201034</b> 80x100x13 LD

■ : Delik - Çentik

■ : Hole - Notch

■ : Trou - Entaille

NOT: Katalogdaki Orijinal Kodlar Referans Amacıyla Kullanılmıştır. Lütfen Oto Conta Kodlarını Kullanınız.  
Original codes used for reference only. Please use OTO CONTA codes for orders.



RENAULT

00



01



02



03



04



Silindir Kapak  
Cylinder Head  
Zylinderkopf  
Joint de culasse



Ltr	MODEL	PS/KW	ENGINE/MOTOR		
1,4 1397	<b>4 CYL ø76</b> R 18 03/80-->04/89 TRAFIC 03/80-->06/91  FUEGO 02/80-->10/85	64 PS / 47 KW 48 PS / 35 KW  64 PS / 47 KW	847.20 / C1J 847.700 847.701 C1J.700 847.720	<b>40125002</b> 77 01 460 626	 <b>40102005</b> 77 00 680 689 1,20mm <b>40102006</b> 77 00 680 689 1,40mm <b>40102009</b> 77 00 680 689 1,80mm <b>ø77</b>
1,4 1397	<b>4 CYL ø76</b> R 9 08/76--> R 11 R 12 R 19 R 21 SUPERCINGO SUPER 5 RAPID	72 PS / 53 KW 58 PS / 43 KW	C1J 715 C2J 717 C2J 718 C2J 720 C2J 730 C2J 756 C2J 766 C2J 768 C3J 700 C3J 702 C3J 710 C3J 756 C3J 760 C3J 762	<b>▲ 40103001</b> Motor Takım Gasket Set  <b>40103002</b> Motor Full Takım Gasket Full Set  <b>40103003</b> 77 01 462 216	 <b>40102005</b> 77 00 680 689 1,20mm <b>40102006</b> 77 00 680 689 1,40mm <b>40102009</b> 77 00 680 689 1,80mm <b>ø77</b>
1,4 1397	<b>4 CYL ø76</b> R 9 08/76--> R 11 R 12 R 19 R 21 SUPERCINGO SUPER 5 RAPID	72 PS / 53 KW 58 PS / 43 KW	C1J 715 C2J 717 C2J 718 C2J 720 C2J 730 C2J 756 C2J 766 C2J 768 C3J 700 C3J 702 C3J 710 C3J 756 C3J 760 C3J 762	<b>▲ 40103101</b> Motor Takım Gasket Set  <b>40103102</b> Motor Full Takım Gasket Full Set  <b>40103003</b> 77 01 462 216	 <b>40102005</b> 77 00 680 689 1,20mm <b>40102006</b> 77 00 680 689 1,40mm <b>40102009</b> 77 00 680 689 1,80mm <b>ø77</b>

▲ : İçerikte Bulunmamaktadır...

▲ : Not included in the set

▲ : Non inclus dans la pochette

00: Motor Takım Keçesiz ve Subap Lastiksiz



















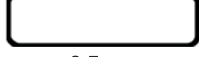

00: Gasket Set Without oil seals Without Valve Stem Seal

01: Motor Takım Keçesiz - Subap Lastikli

01: Gasket set With Valve Stem Seal Without Oil Seals

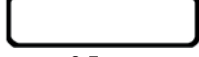
02: Motor Full Takım Keçeli ve Subap Lastikli

02: Gasket Full Set With oil seals and Valve Stem Seals

<p>Subap Kapak Valve Cover Gasket Zylinderkopfhaube Couvre-culbut.</p> 	<p>Karter Oil Pan Ölwanne Carter d'huile</p> 	<p>Emme Manifold Intake Manifold Ansaug Admission</p> 	<p>Egzoz Manifold Exhaust Manifold Auspuffkrümmer Collecteur D'echappement</p> 	<p>Eksoz Boğaz Exhaust Pipe Auspuff Kehle</p> 	<p>Supap Keçesi Valve Stem Seal Ventilschaft Queue de soupape</p> 	  
 <p>6,5mm <b>40102525</b> 77 01 348 574</p>	 <p><b>40102265</b> 77 01 457 561</p>	 <p><b>40101020</b> 77 00 559 702</p>				<p><b>21208067</b> 35x50x10 RD</p> <p><b>21201034</b> 80x100x13 LD</p>
 <p>6,5mm <b>40102525</b> 77 01 348 574</p>	 <p><b>40102265</b> 77 01 457 561</p>	 <p><b>40103020</b> 77 00 855 962</p>			 <p>▲ <b>40103027x8</b> 77 00 658 325 <b>7x10,8x13x9,8</b></p>	<p>▲ <b>21208067</b> 35x50x10 RD</p> <p>▲ <b>21201034</b> 80x100x13 LD</p>
 <p>6,5mm <b>40102525</b> 77 01 348 574</p>	 <p><b>40102268x4</b> 77 00 564 813</p>	 <p><b>40103020</b> 77 00 855 962</p>			 <p>▲ <b>40103027x8</b> 77 00 658 325 <b>7x10,8x13x9,8</b></p>	<p>▲ <b>21208067</b> 35x50x10 RD</p> <p>▲ <b>21201034</b> 80x100x13 LD</p>

■ : Delik - Çentik

■ : Hole - Notch

■ : Trou - Entaille

NOT: Katalogdaki Orijinal Kodlar Referans Amacıyla Kullanılmıştır.Lütfen Oto Conta Kodlarını Kullanınız.  
Original codes used for reference only.Please use OTO CONTA codes for orders.



RENAULT

00



01



02



03



04



Silindir Kapak  
Cylinder Head  
Zylinderkopf  
Joint de culasse



Ltr	MODEL	PS/KW	ENGINE/MOTOR		
1,4 1397	4 CYL ø76 SUPER SUPER 5 SUPER 5 Turbo 11 11 Turbo 9 Turbo	120 PS / 88 KW 105 PS / 77 KW	C1J 760 C1J 764 C1J 770 C1J 782 C1J 784 C1J 788	<b>40107602</b> 77 01 465 268	 <b>40107605</b> 77 00 733 041 1,40mm ø77
1,5 1461	4 CYL ø76 CLIO dCi CLIO DCI KANGOO DCI SCÉNIC DCI THALIA THALIA dCi THALIA DCI	82 PS / 60 KW 65 PS / 48 KW	K9K 700 K9K 702 K9K 704 K9K 710 K9K 722	<b>42457102</b> Motor Full Takım Gasket Full Set <b>42457103</b> 77 01 473 371 <b>42457104</b> Motor Alt Takım Conversion Set	 <b>42457105</b> 82 00 071 111 0,60mm <b>42457106</b> 82 00 071 111 0,82mm MLS ø77,5
1,5 1461	4 CYL ø76 CLIO CLIO dCi MODUS THALIA dCi TWINGO dCi CLIO dCi MEGANE DCI SCÉNIC DCI	82 PS / 60 KW 64 PS / 47 KW 82 PS / 60 KW 86 PS / 63 KW 82 PS / 60 KW	K9K 706 K9K 740 K9K 750 K9K 752 K9K 790 K9K 716 K9K 722	<b>42456902</b> Motor Full Takım Gasket Full Set <b>42457003</b> 77 01 476 729 <b>42457104</b> Motor Alt Takım Conversion Set	 <b>42457005</b> 82 00 351 353 0,70mm <b>42457006</b> 82 00 351 353 0,82mm MLS ø77,5
1,5 1461	4 CYL ø76 CLIO DCI GRAND SCÉNIC dCi GRAND SCÉNIC DCI MEGANE dCi MEGANE DCI SCÉNIC dCi SCÉNIC DCI	106 PS / 78 KW 100 PS / 74 KW	K9K 712 K9K 728	<b>42457002</b> Motor Full Takım Gasket Full Set <b>42457003</b> 77 01 476 729 <b>42457004</b> Motor Alt Takım Conversion Set	 <b>42457005</b> 82 00 351 353 0,70mm <b>42457006</b> 82 00 351 353 0,82mm MLS ø77,5

▲ : İçerikte Bulunmamaktadır...

▲ : Not included in the set

▲ : Non inclus dans la pochette

00: Motor Takım Keçesiz ve Subap Lastiksiz











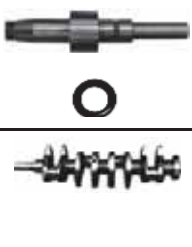









00: Gasket Set Without oil seals Without Valve Stem Seal

01: Motor Takım Keçesiz - Subap Lastikli

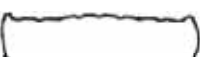
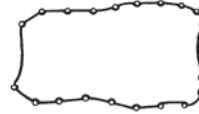
01: Gasket set With Valve Stem Seal Without Oil Seals

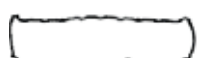
02: Motor Full Takım Keçeli ve Subap Lastikli

02: Gasket Full Set With oil seals and Valve Stem Seals

Subap Kapak Valve Cover Gasket Zylinderkopfhaube Couvre-culbut.	Karter Oil Pan Ölwanne Carter d'huile	Emme Manifold Intake Manifold Ansaug Admission	Egzoz Manifold Exhaust Manifold Auspuffkrümmer Collecteur D'échappement	Eksoz Boğaz Exhaust Pipe Auspuff Kehle	Supap Keçesi Valve Stem Seal Ventilschaft Queue de soupape	
						
 6,5mm <b>40102525</b> 77 01 348 574	 <b>40102267</b> 77 00 564 813	 <b>40103020</b> 77 00 855 962				<b>21208067</b> 35x50x10 RD  <b>21201034</b> 80x100x13 LD
 <b>42457125</b> 82 00 117 388	 <b>42457165</b> 77 00 273 486		 <b>42457121</b> 82 00 128 551		 <b>42457144x8</b> 77 00 109 840 <b>6x8,8x12,2x9,7</b>	<b>21204024</b> 28x42x5 RD  <b>21204025</b> 35x47x7 RD  <b>21204033</b> 80x100x9 LD
 <b>42457125</b> 82 00 117 388	 <b>42457165</b> 77 00 273 486		 <b>42457021</b> 82 00 414 346		 <b>42457144x8</b> 77 00 109 840 <b>6x8,8x12,2x9,7</b>	<b>21204024</b> 28x42x5 RD  <b>21204025</b> 35x47x7 RD  <b>21204033</b> 80x100x9 LD
 <b>42457125</b> 82 00 117 388	 <b>42457065</b> 82 00 379 654		 <b>42457021</b> 82 00 414 346		 <b>42457144x8</b> 77 00 109 840 <b>6x8,8x12,2x9,7</b>	<b>21204024</b> 28x42x5 RD  <b>21204025</b> 35x47x7 RD  <b>21204033</b> 80x100x9 LD











■ : Delik - Çentik

■ : Hole - Notch

■ : Trou - Entaille

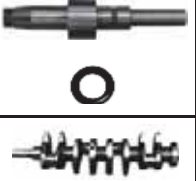
NOT: Katalogdaki Orijinal Kodlar Referans Amacıyla Kullanılmıştır. Lütfen Oto Conta Kodlarını Kullanınız.  
Original codes used for reference only. Please use OTO CONTA codes for orders.



<p>Subap Kapak Valve Cover Gasket Zylinderkopfhaube Couvre-culbut.</p> 	<p>Karter Oil Pan Ölwanne Carter d'huile</p> 	<p>Emme Manifold Intake Manifold Ansaug Admission</p> 	<p>Egzoz Manifold Exhaust Manifold Auspuffkrümmer Collecteur D'echappement</p> 	<p>Eksoz Boğaz Exhaust Pipe Auspuff Kehle</p> 	<p>Supap Keçesi Valve Stem Seal Ventilschaft Queue de soupape</p> 	
 <p><b>42457525</b> 77 01 070 607</p>	 <p><b>42457065</b> 82 00 379 654</p>		 <p><b>42457021</b> 82 00 414 346</p>		 <p><b>42457144x8</b> 77 00 109 840 82 00 496 321 6x8,8x12,2x9,7</p>	<p><b>21204710</b> 28x42x6 RD</p>
						<p><b>21204025</b> 35x47x7 RD</p> <p><b>21204033</b> 80x100x9 LD</p>











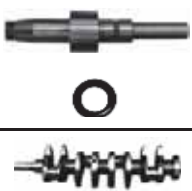







■ : Delik - Çentik

■ : Hole - Notch

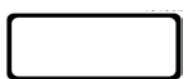
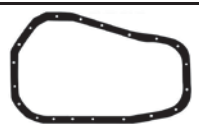
■ : Trou - Entaille

NOT: Katalogdaki Orijinal Kodlar Referans Amacıyla Kullanılmıştır.Lütfen Oto Conta Kodlarını Kullanınız.  
Original codes used for reference only.Please use OTO CONTA codes for orders.



Subap Kapak Valve Cover Gasket Zylinderkopfhaube Couvre-culbut.	Karter Oil Pan Ölwanne Carter d'huile	Emme Manifold Intake Manifold Ansaug Admission	Egzoz Manifold Exhaust Manifold Auspuffkrümmer Collecteur D'echappement	Eksoz Boğaz Exhaust Pipe Auspuff Kehle	Supap Keçesi Valve Stem Seal Ventilschaft Queue de soupape	
						
<b>42457125</b> 82 00 117 388	<b>42457065</b> 82 00 379 654		<b>42457021</b> 82 00 414 346		<b>42457144x8</b> 77 00 109 840 6x8,8x12,2x9,7	<b>21204024</b> 28x42x5 RD
						<b>21204025</b> 35x47x7 RD
						<b>21204033</b> 80x100x9 LD
						<b>21204024</b> 28x42x5 RD
<b>42457025</b> 77 01 066 400	<b>42457065</b> 82 00 379 654		<b>42457021</b> 82 00 414 346		<b>42457144x8</b> 77 00 109 840 6x8,8x12,2x9,7	<b>21204025</b> 35x47x7 RD
						<b>21204033</b> 80x100x9 LD
						<b>21201010</b> 32x45x8 RD
<b>40110525</b> 77 00 725 186	<b>40110265</b> 7700710279	<b>40109020</b> 77 00 635 407				<b>21201034</b> 80x100x13 LD
						<b>21204002</b> 25x42x8 RD
<b>40104525</b> 77 00 719 666	<b>40113265</b> 77 00 859 751	<b>40113021</b> 77 00 103 849			<b>40107027x8</b> 77 00 737 124 8x10,8x14,2x10	<b>21201027</b> 50x68x10 RD
						<b>21201038</b> 85x105x8 LD

■ : Delik - Çentik

■ : Hole - Notch

■ : Trou - Entaille

NOT: Katalogdaki Orijinal Kodlar Referans Amacıyla Kullanılmıştır.Lütfen Oto Conta Kodlarını Kullanınız.  
Original codes used for reference only.Please use OTO CONTA codes for orders.



RENAULT

00



01



02



03



04



Silindir Kapak  
Cylinder Head  
Zylinderkopf  
Joint de culasse



Ltr	MODEL	PS/KW	ENGINE/MOTOR		
1,6 1598	4 CYL ø79,5 CLIO 16V 11/97--> LAGUNA 16V MEGANE MEGANE Grandtour 16V MEGANE 16V SCÉNIC SCÉNIC 16V THALIA 16V  CLIO 03/01--> KANGOO 16V LAGUNA 16V  LAGUNA 06/01--> TWINGO	109 PS / 80 KW 90 PS / 66 KW  116 PS / 85 KW 95 PS / 70 KW  133 PS / 98 KW 103 PS / 76 KW	K4M 700 K4M 701 K4M 704 K4M 706 K4M 708 K4M 709 K4M 711 K4M 712 K4M 720 K4M 724 K4M 730 K4M 732 K4M 734 K4M 736 K4M 740 K4M 742 K4M 743 K4M 748 K4M 762 K4M 768 K4M 710 K4M 744 K4M 745 K4M 746 K4M 750 K4M 752 K4M 753 K4M 764 K4M 718 K4M 754	<b>42457202</b> Motor Full Takım Gasket Full Set  <b>42457203</b> 77 01 471 886  <b>42457204</b> Alt Takım Conversion Set	 <b>42457205</b> 77 00 112 739 MLS ø80,5
1,6 1598	4 CYL ø79,5 LAGUNA 16V 02/05--> MEGANE 11/02--> MEGANE 16V CLIO 06/03--> GRAND SCÉNIC MEGANE SCÉNIC MEGANE 01/07--> SCÉNIC KANGOO 02/08-->	112 PS / 82 KW 113 PS / 83 KW 112 PS / 82 KW 128 PS / 94 KW 109 PS / 81 KW  112 PS / 82 KW 106 PS / 78 KW	K4M 716 K4M 760  K4M 761 K4M 766 K4M 782 K4M 858 K4M 862 K4M 866 K4M 730	<b>42456702</b> Motor Full Takım Gasket Full Set  <b>42457403</b> 77 01 474 372  <b>42457204</b> Alt Takım Conversion Set	 <b>42457205</b> 77 00 112 739 MLS ø80,5

▲ : İçerikte Bulunmamaktadır...

▲ : Not included in the set

▲ : Non inclus dans la pochette

00: Motor Takım Keçesiz ve Subap Lastiksiz



















00: Gasket Set Without oil seals Without Valve Stem Seal

01: Motor Takım Keçesiz - Subap Lastikli

01: Gasket set With Valve Stem Seal Without Oil Seals

02: Motor Full Takım Keçeli ve Subap Lastikli

02: Gasket Full Set With oil seals and Valve Stem Seals

Subap Kapak Valve Cover Gasket Zylinderkopfhaube Couvre-culbut.	Karter Oil Pan Ölwanne Carter d'huile	Emme Manifold Intake Manifold Ansaug Admission	Egzoz Manifold Exhaust Manifold Auspuffkrümmer Collecteur D'echappement	Eksoz Boğaz Exhaust Pipe Auspuff Kehle	Supap Keçesi Valve Stem Seal Ventilschaft Queue de soupape	
						
	 <b>42457265</b> 77 00 103 687	 <b>42457218x4</b> 82 00 052 312  <b>42457219</b> 77 00 105 852	 <b>42457221</b> 77 00 107 181		 <b>42457244x16</b> 77 00 103 938 5,5x11x28x16,4	<b>21204024x2</b> 28x42x5 RD  <b>21204005</b> 35x47x7 RD  <b>21204009</b> 80x100x8 LD
	 <b>42457265</b> 77 00 103 687	 <b>42457219</b> 77 00 105 852  <b>42457418x4</b> 82 00 275 057	 <b>42457221</b> 77 00 107 181  <b>42457222</b> 82 00 365 915		 <b>42457244x16</b> 77 00 103 938 5,5x11x28x16,4	<b>21208071</b> 33x42x6 RD  <b>21204024</b> 28x42x5 RD  <b>21204005</b> 35x47x7 RD  <b>21204009</b> 80x100x8 LD

■ : Delik - Çentik

■ : Hole - Notch

■ : Trou - Entaille

NOT: Katalogdaki Orijinal Kodlar Referans Amacıyla Kullanılmıştır.Lütfen Oto Conta Kodlarını Kullanınız.  
Original codes used for reference only.Please use OTO CONTA codes for orders.



RENAULT

00



Silindir Kapak  
Cylinder Head  
Zylinderkopf  
Joint de culasse

01



02



03



04



Ltr	MODEL	PS/KW	ENGINE/MOTOR		
1,6 1598	4 CYL ø79,5 MEGANE 01/96-->03/99 LOGAN KANGOO MEGANE Grandtour MEGANE Scenic THALIA	90 PS / 66 KW 75 PS / 55 KW	K7M 702 K7M 703 K7M 710 K7M 720 K7M 746 K7M 790	<b>40149002</b> Motor Full Takım Gasket Full Set  <b>40149003</b> 77 01 468 710  <b>40149004</b> Alt Takım Conversion Set	 <b>40149005</b> 77 00 866 683 1,40mm  <b>40149006</b> 77 00 866 683 1,60mm <b>ø80</b>
1,6 1598	4 CYL ø79,5 CLIO 09/98-->05/05 MEGANE	90 PS / 66 KW 87 PS / 64 KW	K7M 704 K7M 744 K7M 745	<b>40149102</b> Motor Full Takım Gasket Full Set  <b>40149103</b> Üst Takım Gasket Head Set  <b>40149004</b> Alt Takım Conversion Set	 <b>40149005</b> 77 00 866 683 1,40mm  <b>40149006</b> 77 00 866 683 1,60mm <b>ø80</b>
1,6 1598	4 CYL ø79,5 GRAND SCÉNIC 06/05--> LOGAN MEGANE SCÉNIC	105 PS / 77 KW	K4M 690 K4M 788	<b>42456602</b> Motor Full Takım Gasket Full Set  <b>42456603</b> 77 01 471 886  <b>42457204</b> Alt Takım Conversion Set	 <b>42457205</b> 77 00 112 739 <b>MLS</b> <b>ø80,5</b>

▲ : İçerikte Bulunmamaktadır...

▲ : Not included in the set

▲ : Non inclus dans la pochette

00: Motor Takım Keçesiz ve Subap Lastiksiz



















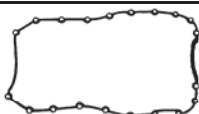





00: Gasket Set Without oil seals Without Valve Stem Seal

01: Motor Takım Keçesiz - Subap Lastikli

01: Gasket set With Valve Stem Seal Without Oil Seals

02: Motor Full Takım Keçeli ve Subap Lastikli

02: Gasket Full Set With oil seals and Valve Stem Seals

Subap Kapak Valve Cover Gasket Zylinderkopfhaube Couvre-culbut.	Karter Oil Pan Ölwanne Carter d'huile	Emme Manifold Intake Manifold Ansaug Admission	Egzoz Manifold Exhaust Manifold Auspuffkrümmer Collecteur D'echappement	Eksoz Boğaz Exhaust Pipe Auspuff Kehle	Supap Keçesi Valve Stem Seal Ventilschaft Queue de soupape	
						
		 <b>40108918x4</b> 77 01 471 932	 <b>40149020</b> 77 00 867 360		 <b>40116026x8</b> 77 00 103 872 7x9,8/13.2x10	<b>21208003</b> 30x42x7 RD
<b>40116527</b> 77 01 471 719	<b>42457165</b> 77 00 273 486	 <b>40149018x4</b> 77 01 471 816				<b>21208001</b> 35x47x7 RD
		 <b>40149019</b> 77 00 865 764				<b>21208012</b> 80x100x8 LD
		 <b>40116019</b> 77 00 273 827	 <b>40149020</b> 77 00 867 360		 <b>40116026x8</b> 77 00 103 872 7x9,8/13.2x10	<b>21208003</b> 30x42x7 RD
<b>40116527</b> 77 01 471 719	<b>42457165</b> 77 00 273 486	 <b>40149018x4</b> 77 01 471 816				<b>21208001</b> 35x47x7 RD
						<b>21208012</b> 80x100x8 LD
		 <b>42457418x4</b> 82 00 275 057	 <b>42457222</b> 82 00 365 915		 <b>42457244x16</b> 77 00 103 938 5,5x11x28x16,4	<b>21204024x2</b> 28x42x5 RD
	<b>42457265</b> 77 00 103 687	 <b>42457219</b> 77 00 105 852				<b>21204005</b> 35x47x7 RD
						<b>21204009</b> 80x100x8 LD

■ : Delik - Çentik

■ : Hole - Notch

■ : Trou - Entaille

NOT: Katalogdaki Orijinal Kodlar Referans Amacıyla Kullanılmıştır. Lütfen Oto Conta Kodlarını Kullanınız.  
Original codes used for reference only. Please use OTO CONTA codes for orders.



# RENAULT

00



01



02



03



04



Silindir Kapak  
Cylinder Head  
Zylinderkopf  
Joint de culasse



Ltr	MODEL	PS/KW	ENGINE/MOTOR		
1,6 1598	4 CYL ø79,5 CLIO CLIO 16V MODUS CLIO CLIO 16V MODUS TWINGO CLIO 16V	12/04--> 12/04--> 06/05-->	112 PS / 82 KW K4M 790 K4M 800 133 PS / 98 KW 88 PS / 65 KW K4M 791 K4M 792 K4M 794 K4M 801 K4M 854 K4M 804 88 PS / 65 KW	42457402 Motor Full Takım Gasket Full Set 42457403 77 01 474 372 42457404 Alt Takım Conversion Set	 42457205 77 00 112 739 MLS ø80,5
	4 CYL ø79,5 KANGOO LOGAN	02/08--> 09/04-->	105 PS / 77 KW 84 PS / 62 KW 87 PS / 64 KW K7M 690 K7M 718 K7M 732 K7M 750 K7M 710	40108902 40108903+40149004 40108903 60 01 548 043 40149004 Motor Alt Takım Conversion Set	 40108905 82 00 296 969 1,20mm FIBER / FIBRE 40108906 82 00 296 969 MLS ø80,5
1,6	4 CYL ø76 21 OPTIMA FAIRWAY		C2L C3L	40107602 77 01 465 268	 40107605 77 00 733 041 1,40mm ø77
1,6 1647	4 CYL ø79 R 18 TRAFIC FUEGO		73 PS / 53 KW 79 PS / 55 KW 66 PS / 50 KW 841 717 A2M 723 841 717 A2M 723 841 717 841 A1MP707	40110002 77 01 460 627	 40110005 77 01 460 708 1,20mm ø80,5
1,7 1721	4 CYL ø81 TRAFIC	06/86-->08/94	68 PS / 50 KW F1N 720 F1N 722 F1N 724	40107002 Motor Full Takım Gasket Full Set 40107003 77 01 466 406 40107004 77 01 462 817	 40107005 77 00 713 860 1,40mm 40107009 77 00 713 860 1,80mm ø82

▲ : İçerikte Bulunmamaktadır...

▲ : Not included in the set

▲ : Non inclus dans la pochette

00: Motor Takım Keçesiz ve Subap Lastiksiz











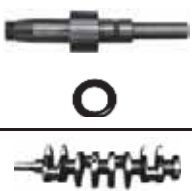













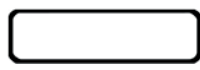

00: Gasket Set Without oil seals Without Valve Stem Seal

01: Motor Takım Keçesiz - Subap Lastikli

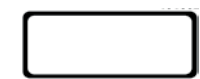
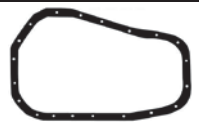
01: Gasket set With Valve Stem Seal Without Oil Seals

02: Motor Full Takım Keçeli ve Subap Lastikli

02: Gasket Full Set With oil seals and Valve Stem Seals

Subap Kapak Valve Cover Gasket Zylinderkopfhaube Couvre-culbut.	Karter Oil Pan Ölwanne Carter d'huile	Emme Manifold Intake Manifold Ansaug Admission	Egzoz Manifold Exhaust Manifold Auspuffkrümmer Collecteur D'échappement	Eksoz Boğaz Exhaust Pipe Auspuff Kehle	Supap Keçesi Valve Stem Seal Ventilschaft Queue de soupape	
						
	 <b>42457065</b> 82 00 379 654	 <b>42457219</b> 77 00 105 852  <b>42457418x4</b> 82 00 275 057	 <b>42457221</b> 77 00 107 181  <b>42457222</b> 82 00 365 915		 <b>42457244x16</b> 77 00 103 938 5,5x11x28x16,4	<b>21208071</b> 33x42x6 RD <b>21204024</b> 28x42x5 RD <b>21204005</b> 35x47x7 RD <b>21204009</b> 80x100x8 LD
	 <b>42457165</b> 77 00 273 486	 <b>40108918x4</b> 77 01 471 932	 <b>40108921</b> 8200191371		 <b>40116026x8</b> 77 00 103 872 7x9,8/13.2x10	<b>21208003</b> 30x42x7 RD <b>21208001</b> 35x47x7 RD <b>21208012</b> 80x100x8 LD
 6,5mm <b>40102525</b> 77 01 348 574	 <b>40102267</b> 77 00 564 813	 <b>40103020</b> 77 00 855 962				<b>21208067</b> 35x50x10 RD <b>21201034</b> 80x100x13 LD
 <b>40110525</b> 77 00 725 186	 <b>40110265</b> 7700710279	 <b>40109020</b> 77 00 635 407				<b>21201010</b> 32x45x8 RD <b>21201034</b> 80x100x13 LD
 <b>40104525</b> 77 00 719 666	 <b>42427465</b>	 <b>40107021</b> 77 00 725 397			 <b>40107027x8</b> 77 00 737 124 8x10,8x14,2x10	<b>21201002</b> 22x45x7 LD <b>21201003</b> 25x42x7 RD <b>21201027</b> 50x68x10 RD <b>21201038</b> 85x105x8 LD

■ : Delik - Çentik

■ : Hole - Notch

■ : Trou - Entaille

NOT: Katalogdaki Orijinal Kodlar Referans Amacıyla Kullanılmıştır.Lütfen Oto Conta Kodlarını Kullanınız.  
Original codes used for reference only.Please use OTO CONTA codes for orders.



RENAULT

00



Silindir Kapak  
Cylinder Head  
Zylinderkopf  
Joint de culasse

01



02



03



04



Ltr MODEL PS/KW ENGINE/MOTOR

Ltr	MODEL	PS/KW	ENGINE/MOTOR		
1,7	4 CYL ø81				
1721	11 10/83-->	94 PS / 69 KW	F2N 700	<b>60107002</b>	
	19	73 PS / 54 KW	F2N 704	Motor Full Takım	
	21		F2N 708	Gasket Full Set	
	CLIO		F2N 710		<b>60107005</b>
	SUPER 5		F2N 711		77 00 713 860
	5		F2N 712	<b>60107003</b>	1,40mm
	9		F2N 716	77 01 466 406	
			F2N 720	<b>60107004</b>	<b>60107009</b>
			F2N 721	77 01 462 817	77 00 713 860
			F2N 722		1,80mm
			F2N 724		<b>ø82</b>
			F2N 726		
			F2N 727		
			F2N 728		
			F2N 730		
			F2N 732		
			F2N 740		
			F2N 742		
			F2N 750		
			F2N 752		
			F2N 753		
			F2N 754		
			F2N 758		
			F2N 770		
			F2N 783		
			F2N 786		
			F2N 796		
			F2N 797		
			F2N 798		
	11 10/84-->12/95	107 PS / 79 KW	F3N 702		
	19	73 PS / 54 KW	F3N 708		
	21		F3N 716		
	9		F3N 717		
	SUPER 5		F3N 718		
			F3N 722		
			F3N 723		
			F3N 726		
			F3N 740		
			F3N 741		
			F3N 742		
			F3N 743		
			F3N 746		

▲ : İçerikte Bulunmamaktadır...

▲ : Not included in the set

▲ : Non inclus dans la pochette

00: Motor Takım Keçesiz ve Subap Lastiksiz













00: Gasket Set Without oil seals Without Valve Stem Seal

01: Motor Takım Keçesiz - Subap Lastikli

01: Gasket set With Valve Stem Seal Without Oil Seals

02: Motor Full Takım Keçeli ve Subap Lastikli

02: Gasket Full Set With oil seals and Valve Stem Seals

<p>Subap Kapak Valve Cover Gasket Zylinderkopfhaube Couvre-culbut.</p> 	<p>Karter Oil Pan Ölwanne Carter d'huile</p> 	<p>Emme Manifold Intake Manifold Ansaug Admission</p> 	<p>Egzoz Manifold Exhaust Manifold Auspuffkrümmer Collecteur D'echappement</p> 	<p>Eksoz Boğaz Exhaust Pipe Auspuff Kehle</p> 	<p>Supap Keçesi Valve Stem Seal Ventilschaft Queue de soupape</p> 	  
 <p><b>40104525</b> 77 00 719 666</p>	 <p><b>42427465</b></p>	 <p><b>40107021</b> 77 00 725 397</p>		 <p><b>40107027x8</b> 77 00 737 124 8x10,8x14,2x10</p>	<p><b>21201002</b> 22x45x7 LD</p> <p><b>21201003</b> 25x42x7 RD</p> <p><b>21201027</b> 50x68x10 RD</p> <p><b>21201038</b> 85x105x8 LD</p>	

■ : Delik - Çentik

■ : Hole - Notch

■ : Trou - Entaille

NOT: Katalogdaki Orijinal Kodlar Referans Amacıyla Kullanılmıştır.Lütfen Oto Conta Kodlarını Kullanınız.  
Original codes used for reference only.Please use OTO CONTA codes for orders.



RENAULT

00



Silindir Kapak  
Cylinder Head  
Zylinderkopf  
Joint de culasse

01



02



03



04



Ltr	MODEL	PS/KW	ENGINE/MOTOR		
1,8 1794	4 CYL ø82,7 CLIO CLIO Rsi LAGUNA 19 08/90-->03/01	110 PS / 81 KW 88 PS / 65 KW	F3P 670 F3P 676 F3P 678 F3P 682 F3P 700 F3P 704 F3P 705 F3P 706 F3P 707 F3P 708 F3P 710 F3P 712 F3P 714 F3P 720 F3P 724 F3P 754 F3P 755 F3P 758 F3P 760 F3P 764 F3P 765	<b>40134002</b> Motor Full Takım Gasket Full Set <b>40134003</b> 77 01 467 058 <b>40113004</b> 77 01 462 817	 <b>40134005</b> 77 00 859 273 1,20mm <b>40134007</b> 77 00 859 273 1,60mm <b>ø83,7</b>
1,8 1794	4 CYL ø82,7 LAGUNA 06/95-->02/01	94 PS / 69 KW	F3P 674	<b>40134003</b> 77 01 467 058 <b>40152104</b> 77 01 470 176	 <b>40134005</b> 77 00 859 273 1,20mm <b>40134007</b> 77 00 859 273 1,60mm <b>ø83,7</b>
1,8 1783	4 CYL ø82,7 LAGUNA 16V MEGANE Grandtour 16V MEGANE 16V SCÉNIC SCÉNIC 16V LAGUNA 16V 04/98--> 03/01-->	120 PS / 88 KW 115 PS / 85 KW 121 PS / 89 KW 116 PS / 85 KW	F4P 720 F4P 722 F4P 760 F4P 771 F4P 773 F4P 775 F4P 770 F4P 772 F4P 774	<b>42457302</b> Motor Full Takım Gasket Full Set <b>42457303</b> 77 01 471 278 <b>42457304</b> 77 01 477 218 77 01 471 360	 <b>42457305</b> 77 00 108 254 MLS <b>ø84</b>

▲ : İçerikte Bulunmamaktadır...

▲ : Not included in the set

▲ : Non inclus dans la pochette

00: Motor Takım Keçesiz ve Subap Lastiksiz



















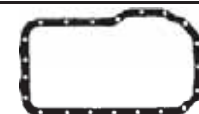

00: Gasket Set Without oil seals Without Valve Stem Seal

01: Motor Takım Keçesiz - Subap Lastikli

01: Gasket set With Valve Stem Seal Without Oil Seals

02: Motor Full Takım Keçeli ve Subap Lastikli

02: Gasket Full Set With oil seals and Valve Stem Seals

Subap Kapak Valve Cover Gasket Zylinderkopfhaube Couvre-culbut.	Karter Oil Pan Ölwanne Carter d'huile	Emme Manifold Intake Manifold Ansaug Admission	Egzoz Manifold Exhaust Manifold Auspuffkrümmer Collecteur D'echappement	Eksoz Boğaz Exhaust Pipe Auspuff Kehle	Supap Keçesi Valve Stem Seal Ventilschaft Queue de soupape	
						
 <b>40104525</b> 77 00 719 666	 <b>40113265</b> 77 00 859 751	 <b>40134021</b> 77 00 854 539			 <b>40107027x8</b> 77 00 737 124 8x10,8x14,2x10	<b>21201002</b> 22x45x7 LD <b>21201003</b> 25x42x7 RD <b>21201027</b> 50x68x10 RD <b>21201038</b> 85x105x8 LD
 <b>40104525</b> 77 00 719 666	 <b>40152065</b> 77 00 114 424	 <b>40134021</b> 77 00 854 539			 <b>40107027x8</b> 77 00 737 124 8x10,8x14,2x10	<b>21201002</b> 22x45x7 LD <b>21201003</b> 25x42x7 RD <b>21204014</b> 42x54x6 RD <b>21208011</b> 85x105x11 LD
	 <b>40152065</b> 77 00 114 424	 <b>42457319</b> 77 00 109 906  <b>42457218x4</b> 82 00 052 312	 <b>42457321</b> 77 00 105 843		 <b>42457244x16</b> 77 00 103 938 5,5x11x2816,4	<b>21208070x2</b> 28x47x5,5 RD <b>21204014</b> 42x54x6 RD <b>21208011</b> 85x105x11 LD

■ : Delik - Çentik

■ : Hole - Notch

■ : Trou - Entaille

NOT: Katalogdaki Orijinal Kodlar Referans Amacıyla Kullanılmıştır.Lütfen Oto Conta Kodlarını Kullanınız.  
Original codes used for reference only.Please use OTO CONTA codes for orders.



RENAULT

00



01



02



03











04



Silindir Kapak  
Cylinder Head  
Zylinderkopf  
Joint de culasse



Ltr MODEL PS/KW ENGINE/MOTOR

Ltr	MODEL	PS/KW	ENGINE/MOTOR		
1,9 1870	4 CYL ø80 CLIO DTi 03/99--> CLIO DTi ESPACE dCi ESPACE DCi KANGOO DCi KANGOO DTi LAGUNA dCi LAGUNA DCi MASTER DCi MEGANE dCi MEGANE DCi MEGANE DCi MEGANE DTi MEGANE Grandtour DCi MEGANE Grandtour DTi SCÉNIC DCi SCÉNIC DTi TRAFIC dCi TRAFIC DCi TRAFIC 1.9 dCi	120 PS / 88 KW 80 PS / 59 KW	F9Q 650 F9Q 664 F9Q 674 F9Q 680 F9Q 717 F9Q 718 F9Q 732 F9Q 733 F9Q 738 F9Q 740 F9Q 744 F9Q 748 F9Q 750 F9Q 751 F9Q 752 F9Q 754 F9Q 756 F9Q 760 F9Q 762 F9Q 772 F9Q 774 F9Q 780 F9Q 782 F9Q 790 F9Q 800 F9Q 808 F9Q 820 F9Q 826	40152102 Motor Takım Gasket Set  40152103 77 01 470 288  40152104 77 01 470 176	 40152205 82 00 780 116 1,32mm 40152206 82 00 780 116 1,60mm MLS ø81
1,9 1870	4 CYL ø80 LAGUNA DTi 03/97-->08/03 MEGANE DTi MEGANE Scenic DTi SCÉNIC DTi	98 PS / 72 KW	F9Q 716 F9Q 730 F9Q 734 F9Q 722 F9Q 731 F9Q 736	40152102 Motor Takım Gasket Set  40152103 77 01 470 288  40152104 77 01 470 176	 40152105 77 00 859 059 1,45mm 1  40152106 77 00 105 392 1,35mm 2  40152107 77 00 105 393 1,55mm 3  FIBER / FIBRE ø81

▲ : İçerikte Bulunmamaktadır...

▲ : Not included in the set

▲ : Non inclus dans la pochette

00: Motor Takım Keçesiz ve Subap Lastiksiz

















00: Gasket Set Without oil seals Without Valve Stem Seal

01: Motor Takım Keçesiz - Subap Lastikli

01: Gasket set With Valve Stem Seal Without Oil Seals

02: Motor Full Takım Keçeli ve Subap Lastikli

02: Gasket Full Set With oil seals and Valve Stem Seals

Subap Kapak Valve Cover Gasket Zylinderkopfhaube Couvre-culbut.	Karter Oil Pan Ölwanne Carter d'huile	Emme Manifold Intake Manifold Ansaug Admission	Egzoz Manifold Exhaust Manifold Auspuffkrümmer Collecteur D'echappement	Eksoz Boğaz Exhaust Pipe Auspuff Kehle	Supap Keçesi Valve Stem Seal Ventilschaft Queue de soupape	
						
 <b>40152025</b> 82 00 060 882	 <b>40152065</b> 77 00 114 424	 <b>40152121</b> 77 00 874 592			 <b>40116026x8</b> 77 00 736 465 7x9,8/13.2x10	<b>21204002</b> 25x42x8 RD
						<b>21204014</b> 42x54x6 RD
						<b>21208011</b> 85x105x11 LD
 <b>40152025</b> 82 00 060 882	 <b>40152065</b> 77 00 114 424	 <b>40152121</b> 77 00 874 592			 <b>40116026x8</b> 77 00 736 465 7x9,8/13.2x10	<b>21204002</b> 25x42x8 RD
						<b>21204014</b> 42x54x6 RD
						<b>21208011</b> 85x105x11 LD

■ : Delik - Çentik

■ : Hole - Notch

■ : Trou - Entaille

NOT: Katalogdaki Orijinal Kodlar Referans Amacıyla Kullanılmıştır.Lütfen Oto Conta Kodlarını Kullanınız.  
Original codes used for reference only.Please use OTO CONTA codes for orders.



RENAULT

00



01



02



03



04



Silindir Kapak  
Cylinder Head  
Zylinderkopf  
Joint de culasse



Ltr	MODEL	PS/KW	ENGINE/MOTOR		
1,9 1870	4 CYL ø80 MEGANE DTI 01/96--> MEGANE Scenic DTI TRAFIC D MEGANE D 09/90--> MEGANE DTI MEGANE Scenic DTI MEGANE TDI 19 D 19 DT 19 TD	90 PS / 66 KW 60 PS / 44 KW 94 PS / 69 KW 90 PS / 66 KW	F8Q 600 F8Q 606 F8Q 786 F8Q 610 F8Q 740 F8Q 744 F8Q 768 F8Q 784		 <b>40152005</b> 82 00 188 391 1,60mm 3 <b>M</b> <b>40152006</b> 82 00 188 114 1,50mm 1 <b>M</b> <b>40152007</b> 82 00 188 390 1,40mm 2 <b>M</b> ø81
1,9 1870	4 CYL ø80 19 D 03/86--> 21 D MEGANE D MEGANE Grandtour D MEGANE Scenic DCI RAPID D CLIO CLIO D	65 PS / 48 KW 54 PS / 40 KW	F8Q 620 F8Q 622 F8Q 640 F8Q 678 F8Q 682 F8Q 706 F8Q 710 F8Q 714 F8Q 722 F8Q 724 F8Q 730 F8Q 732 F8Q 742 F8Q 764 F8Q 774 F8Q 776 F8Q 790	<b>40113102</b> Motor Full Takım Gasket Full Set  <b>40113002</b> Motor Takım Gasket Set   <b>40113003</b> 77 01 462 816   <b>40113004</b> 77 01 462 817	 <b>40113005</b> 77 00 745 725 1,85mm 3 <b>M</b> <b>40113006</b> 77 00 743 369 1,75mm 1 <b>M</b> <b>40113007</b> 77 00 745 724 1,65mm 2 <b>M</b> ø81
1,9 1870	4 CYL ø80 CLIO D 01/96--> CLIO dCi KANGOO MEGANE D THALIA D	90 PS / 66 KW 54 PS / 40 KW	F8Q 624 F8Q 630 F8Q 632 F8Q 636 F8Q 644 F8Q 648 F8Q 662	<b>40151902</b> Motor Full Takım Gasket Full Set  <b>40152002</b> Motor Takım Gasket Set   <b>40113003</b> 77 01 462 816   <b>40152104</b> 77 01 470 176	 <b>40152005</b> 82 00 188 391 1,60mm 3 <b>M</b> <b>40152006</b> 82 00 188 114 1,50mm 1 <b>M</b> <b>40152007</b> 82 00 188 390 1,40mm 2 <b>M</b> ø81

▲ : İçerikte Bulunmamaktadır...

▲ : Not included in the set

▲ : Non inclus dans la pochette

00: Motor Takım Keçesiz ve Subap Lastiksiz













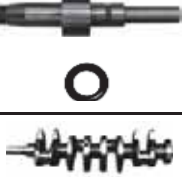

00: Gasket Set Without oil seals Without Valve Stem Seal

01: Motor Takım Keçesiz - Subap Lastikli

01: Gasket set With Valve Stem Seal Without Oil Seals

02: Motor Full Takım Keçeli ve Subap Lastikli

02: Gasket Full Set With oil seals and Valve Stem Seals

<p>Subap Kapak Valve Cover Gasket Zylinderkopfhaube Couvre-culbut.</p> 	<p>Karter Oil Pan Ölwanne Carter d'huile</p> 	<p>Emme Manifold Intake Manifold Ansaug Admission</p> 	<p>Egzoz Manifold Exhaust Manifold Auspuffkrümmer Collecteur D'echappement</p> 	<p>Eksoz Boğaz Exhaust Pipe Auspuff Kehle</p> 	<p>Supap Keçesi Valve Stem Seal Ventilschaft Queue de soupape</p> 	
 <p><b>40104525</b> 77 00 719 666</p>	 <p><b>40113265</b> 77 00 859 751</p>	 <p><b>40113021</b> 77 00 103 849</p>			 <p><b>40107027x8</b> 77 00 737 124 <b>8x10,8x14,2x10</b></p>	<p><b>21204002</b> 25x42x8 RD</p> <p><b>21201027</b> 50x68x10 RD</p> <p><b>21201038</b> 85x105x8 LD</p>
 <p><b>40104525</b> 77 00 719 666</p>	 <p><b>40152065</b> 77 00 114 424</p>	 <p><b>40113021</b> 77 00 103 849</p>			 <p><b>40107027x8</b> 77 00 737 124 <b>8x10,8x14,2x10</b></p>	<p><b>21204002</b> 25x42x8 RD</p> <p><b>21204014</b> 42x54x6 RD</p> <p><b>21208011</b> 85x105x11 LD</p>

■ : Delik - Çentik

■ : Hole - Notch

■ : Trou - Entaille

NOT: Katalogdaki Orijinal Kodlar Referans Amacıyla Kullanılmıştır.Lütfen Oto Conta Kodlarını Kullanınız.  
Original codes used for reference only.Please use OTO CONTA codes for orders.



RENAULT

00



Silindir Kapak  
Cylinder Head  
Zylinderkopf  
Joint de culasse

01



02



03



04



Ltr	MODEL	PS/KW	ENGINE/MOTOR		
2.0 1998	4 CYL ø82,7 ESPACE 06/95--> LAGUNA MEGANE MEGANE Scenic	114 PS / 84 KW 109 PS / 80 KW	F3R 611 F3R 742 F3R 768 F3R 769 F3R 791 F3R 796 F3R 797 F3R 798	40134003 77 01 467 058  40152104 77 01 470 176	 40134005 77 00 859 273 1,20mm 40134007 1,60mm ø83,7
2.0 1998	4 CYL ø82,7 ESPACE 11/93--> LAGUNA MEGANE MEGANE Scenic	114 PS / 84 KW 109 PS / 80 KW	F3R 722 F3R 723 F3R 728 F3R 729 F3R 750 F3R 751 F3R 752	40134002 Motor Full Takım Gasket Full Set  40134003 77 01 467 058  40113004 77 01 462 817	 40134005 77 00 859 273 1,20mm 40134007 1,60mm ø83,7
2.0 1998	4 CYL ø82,7 CLIO 16V 10/98--> ESPACE ESPACE 16V GRAND SCÉNIC LAGUNA LAGUNA 16V MEGANE MEGANE 16V SCÉNIC SCÉNIC 16V THALIA  CLIO 16V 03/01--> TRAFIC  ESPACE 11/02--> TRAFIC	169 PS / 124 KW 133 PS / 98 KW             179 PS / 132 KW 120 PS / 88 KW  136 PS / 100 KW 117 PS / 86 KW	F4R 700 F4R 701 F4R 712 F4R 713 F4R 714 F4R 715 F4R 730 F4R 732 F4R 736 F4R 738 F4R 740 F4R 741 F4R 744 F4R 746 F4R 747 F4R 770 F4R 771 F4R 780 F4R 790 F4R 791 F4R 720 F4R 722 F4R 738 F4R 792 F4R 820		 42457305 77 00 108 254 MLS ø84

▲ : İçerikte Bulunmamaktadır...

▲ : Not included in the set

▲ : Non inclus dans la pochette

00: Motor Takım Keçesiz ve Subap Lastiksiz

















00: Gasket Set Without oil seals Without Valve Stem Seal

01: Motor Takım Keçesiz - Subap Lastikli

01: Gasket set With Valve Stem Seal Without Oil Seals

02: Motor Full Takım Keçeli ve Subap Lastikli

02: Gasket Full Set With oil seals and Valve Stem Seals

Subap Kapak Valve Cover Gasket Zylinderkopfhaube Couvre-culbut.	Karter Oil Pan Ölwanne Carter d'huile	Emme Manifold Intake Manifold Ansaug Admission	Egzoz Manifold Exhaust Manifold Auspuffkrümmer Collecteur D'echappement	Eksoz Boğaz Exhaust Pipe Auspuff Kehle	Supap Keçesi Valve Stem Seal Ventilschaft Queue de soupape	
						
						<b>21201002</b> 22x45x7 LD
<b>40104525</b> 77 00 719 666	<b>40152065</b> 77 00 114 424	<b>40134021</b> 77 00 854 539			<b>40107027x8</b> 77 00 737 124 8x10,8x14,2x10	<b>21201003</b> 25x42x7 RD
						<b>21204014</b> 42x54x6 RD
						<b>21208011</b> 85x105x11 LD
						<b>21201002</b> 22x45x7 LD
<b>40104525</b> 77 00 719 666	<b>40113265</b> 77 00 859 751	<b>40134021</b> 77 00 854 539			<b>40107027x8</b> 77 00 737 124 8x10,8x14,2x10	<b>21201003</b> 25x42x7 RD
						<b>21201027</b> 50x68x10 RD
						<b>21201038</b> 85x105x8 LD

■ : Delik - Çentik

■ : Hole - Notch

■ : Trou - Entaille

NOT: Katalogdaki Orijinal Kodlar Referans Amacıyla Kullanılmıştır.Lütfen Oto Conta Kodlarını Kullanınız.  
Original codes used for reference only.Please use OTO CONTA codes for orders.



RENAULT

00



Silindir Kapak  
Cylinder Head  
Zylinderkopf  
Joint de culasse

01



02



03



04



Ltr MODEL PS/KW ENGINE/MOTOR

Ltr	MODEL	PS/KW	ENGINE/MOTOR		
2.0	4 CYL ø88				
1995	21	03/80-->07/98	120 PS / 88 KW	J5R 716	40112002
	25		79 PS / 58 KW	J5R 718	77 01 460 132
	MASTER			J5R 722	
	MASTER D			J5R 726	
	TRAFIC			J5R 728	
				J7R 722	
				J7R 723	
				J7R 746	
				J7R 747	
				J7R 750	
				J7R 751	
				829 720	
				829 721	
				829 730	
				829 731	
	18	10/77-->10/96	118 PS / 87 KW	J6R 234	40112005
	20		101 PS / 74 KW	J6R 236	77 00 720 788
	21			J6R 706	ø89
	25			J6R 707	
	ESPACE			J6R 710	
	FUEGO			J6R 711	
				J6R 712	
				J6R 713	
				J6R 714	
				J6R 715	
				J6R 716	
				J6R 726	
				J6R 734	
				J6R 758	
				J6R 759	
				J6R 760	
				J6R 762	
				J6R 763	
				J6R 792	
				J6R 793	
				J7R 760	
				J7R 768	
				829 700	
				829 701	
				829 702	
				829 703	
				829 710	
	TRAFIC	03/80-->12/86	103 PS / 76 KW	829 702	
	20		79 PS / 58 KW	829 703	
				829 720	
				829 721	

▲ : İçerikte Bulunmamaktadır...

▲ : Not included in the set

▲ : Non inclus dans la pochette

00: Motor Takım Keçesiz ve Subap Lastiksiz











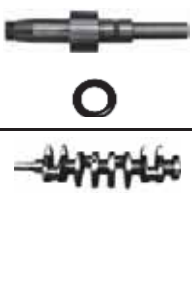



00: Gasket Set Without oil seals Without Valve Stem Seal

01: Motor Takım Keçesiz - Subap Lastikli

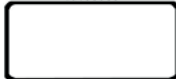
01: Gasket set With Valve Stem Seal Without Oil Seals

02: Motor Full Takım Keçeli ve Subap Lastikli

02: Gasket Full Set With oil seals and Valve Stem Seals

Subap Kapak Valve Cover Gasket Zylinderkopfhaube Couvre-culbut.	Karter Oil Pan Ölwanne Carter d'huile	Emme Manifold Intake Manifold Ansaug Admission	Egzoz Manifold Exhaust Manifold Auspuffkrümmer Collecteur D'echappement	Eksoz Boğaz Exhaust Pipe Auspuff Kehle	Supap Keçesi Valve Stem Seal Ventilschaft Queue de soupape	
						
 <b>40112225</b> 77 00 614 729	 <b>40112265</b> 77 00 591 167	 <b>40112018x4</b> 77 00 728 729  <b>40112019x4</b> 77 00 622 284	 <b>40112120</b> 77 00 622 286	 <b>40112017</b> 77 00 679 861	 <b>40107027x8</b> 77 00 737 124 8x10,8x14,2x10	<b>21201008</b> 30x40x7 RD <b>21201012</b> 35x47x7 RD
						<b>21201027</b> 50x68x10 RD <b>21201041</b> 90x110x11

■ : Delik - Çentik

■ : Hole - Notch

■ : Trou - Entaille

NOT: Katalogdaki Orijinal Kodlar Referans Amacıyla Kullanılmıştır.Lütfen Oto Conta Kodlarını Kullanınız.  
Original codes used for reference only.Please use OTO CONTA codes for orders.



RENAULT

00



01



02



03



04



Silindir Kapak  
Cylinder Head  
Zylinderkopf  
Joint de culasse



Ltr	MODEL	PS/KW	ENGINE/MOTOR		
2,1 2068	4 CYL ø86 18 D 05/79-->07/98 18 TD 20 D 20 TD 21 21 D 21 TD 25 D 25 TD 30 TD ESPACE TD FUEGO TD MASTER MASTER D TRAFIC D	90 PS / 66 KW 58 PS / 43 KW	J8S J8S 120 J8S 232 J8S 234 J8S 240 J8S 330 J8S 702 J8S 704 J8S 706 J8S 708 J8S 711 J8S 712 J8S 714 J8S 738 J8S 742 J8S 746 J8S 750 J8S 758 J8S 772 J8S 774 J8S 776 J8S 814 J8S 890 852 852 (J8S) 852 J8S 852 710 852 720 852 750	40111002 77 01 461 334	 40111005 77 01 035 218 1,80mm 40111006 77 01 035 217 1,60mm 40111007 77 01 034 507 1,75mm ø87
	ESPACE TD 03/86-->04/98 TRAFIC D 21 D 21 TD 25 D	90 PS / 66 KW 64 PS / 47 KW	J8S 600 J8S 604 J8S 610 J8S 612 J8S 620 J8S 736 J8S 740 J8S 778 J8S 784 J8S 786 J8S 788 J8S 760		
	SAFRANE DT 11/93-->07/96	88 PS / 65 KW	J8S 760		
2,2 2188	4 CYL ø87 ESPACE D 03/96-->03/01 ESPACE TD 12V LAGUNA DTI SAFRANE DT	114 PS / 84 KW 113 PS 63 KW	G8T 714 G8T 716 G8T 740 G8T 760		 40125005 77 00 872 860 1,80mm ø88

▲ : İçerikte Bulunmamaktadır...

▲ : Not included in the set

▲ : Non inclus dans la pochette

00: Motor Takım Keçesiz ve Subap Lastiksiz













00: Gasket Set Without oil seals Without Valve Stem Seal

01: Motor Takım Keçesiz - Subap Lastikli

01: Gasket set With Valve Stem Seal Without Oil Seals

02: Motor Full Takım Keçeli ve Subap Lastikli

02: Gasket Full Set With oil seals and Valve Stem Seals

Subap Kapak Valve Cover Gasket Zylinderkopfhaube Couvre-culbut.	Karter Oil Pan Ölwanne Carter d'huile	Emme Manifold Intake Manifold Ansaug Admission	Egzoz Manifold Exhaust Manifold Auspuffkrümmer Collecteur D'echappement	Eksoz Boğaz Exhaust Pipe Auspuff Kehle	Supap Keçesi Valve Stem Seal Ventilschaft Queue de soupape	
						
 <b>40111525</b> 77 00 662 455	 <b>40111265</b> 77 00 591 167	 <b>40111020</b> 77 00 853 496			 <b>40107027x8</b> 77 00 737 124 8x10,8x14,2x10	<b>21201008</b> 30x40x7 RD <b>21201012</b> 35x47x7 RD
						<b>21201027</b> 50x68x10 RD <b>21201041</b> 90x110x11

■ : Delik - Çentik

■ : Hole - Notch

■ : Trou - Entaille

NOT: Katalogdaki Orijinal Kodlar Referans Amacıyla Kullanılmıştır.Lütfen Oto Conta Kodlarını Kullanınız.  
Original codes used for reference only.Please use OTO CONTA codes for orders.



RENAULT

00



01



02



03



04



Silindir Kapak  
Cylinder Head  
Zylinderkopf  
Joint de culasse



Ltr	MODEL	PS/KW	ENGINE/MOTOR			
2,2 2165	4 CYL ø88 ESPACE MASTER TRAFIC	03/80-->07/98	110 PS / 81 KW 91 PS / 67 KW	J7T 284 J7T 600 J7T 718 J7T 719 J7T 734 J7T 736 J7T 756 J7T 770 J7T 772 J7T 773 J7T 776 J7T 780 J7T 782 J7T 788	40112002 77 01 460 132	 40112005 77 00 720 788 ø89
21 25		04/84-->12/89	124 PS / 91 KW 110 PS / 81 KW	J7T 706 J7T 707 J7T 714 J7T 715 J7T 730 J7T 731 J7T 755		
21 25		06/86-->06/94	110 PS / 81 KW 107 PS / 79 KW	J7T 708 J7T 732 J7T 733 J7T 754 J7T 755		
20		10/80-->12/83	116 PS / 85 KW	851 700		
2,4 2445	4 CYL ø93 MASTER D MASTER D MASTER D	08/93-->02/98 09/86-->12/92 09/86-->10/89	71 PS / 52 KW 72 PS / 53 KW 72 PS / 53 KW	S8U 730 S8U 730 S8U 731		 40147005 77 01 040 180 1,80mm 40147006 77 01 040 179 1,70mm ø95,2
2,5 2499	4 CYL ø93 TRAFIC D MASTER D TRAFIC D MASTER D MASTER D TRAFIC D TRAFIC	05/89-->03/01 03/80-->07/98 03/80-->07/98 07/80-->10/89 03/89-->	69 PS / 51 KW 71 PS / 52 KW 69 PS / 51 KW 75 PS / 55 KW 76 PS / 56 KW 75 PS / 55 KW	S8U 720 S8U 722 S8U 731 S8U 742 S8U 742 S8U 748 S8U 750 S8U 752 S8U 758		 40147005 77 01 040 180 1,80mm 40147006 77 01 040 179 1,70mm ø95,2

▲ : İçerikte Bulunmamaktadır...

▲ : Not included in the set

▲ : Non inclus dans la pochette

00: Motor Takım Keçesiz ve Subap Lastiksiz















00: Gasket Set Without oil seals Without Valve Stem Seal

01: Motor Takım Keçesiz - Subap Lastikli

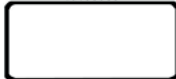
01: Gasket set With Valve Stem Seal Without Oil Seals

02: Motor Full Takım Keçeli ve Subap Lastikli

02: Gasket Full Set With oil seals and Valve Stem Seals

Subap Kapak Valve Cover Gasket Zylinderkopfhaube Couvre-culbut.	Karter Oil Pan Ölwanne Carter d'huile	Emme Manifold Intake Manifold Ansaug Admission	Egzoz Manifold Exhaust Manifold Auspuffkrümmer Collecteur D'echappement	Eksoz Boğaz Exhaust Pipe Auspuff Kehle	Supap Keçesi Valve Stem Seal Ventilschaft Queue de soupape	
						
 <b>40112225</b> 77 00 614 729	 <b>40112265</b> 77 00 591 167	 <b>40112018x4</b> 77 00 728 729	 <b>40112120</b> 77 00 622 286	 <b>40112017</b> 77 00 679 861	 <b>40107027x8</b> 77 00 737 124 8x10,8x14,2x10	<b>21201008</b> 30x40x7 RD <b>21201012</b> 35x47x7 RD
		 <b>40112019x4</b> 77 00 622 284				<b>21201027</b> 50x68x10 RD <b>21201041</b> 90x110x11

■ : Delik - Çentik

■ : Hole - Notch

■ : Trou - Entaille

NOT: Katalogdaki Orijinal Kodlar Referans Amacıyla Kullanılmıştır.Lütfen Oto Conta Kodlarını Kullanınız.  
Original codes used for reference only.Please use OTO CONTA codes for orders.



RENAULT

00



01



02



03



04



Silindir Kapak  
Cylinder Head  
Zylinderkopf  
Joint de culasse



Ltr	MODEL	PS/KW	ENGINE/MOTOR		
2,5 2499	4 CYL ø93 MASTER D 07/98-->01/01	80 PS / 59 KW	S8U 770	40139000 99477116 	 <b>40147005</b> 77 01 040 180 1,80mm <b>40147006</b> 77 01 040 179 1,70mm <b>ø95,2</b>
2,5 2499	4 CYL ø93 TRAFIC D 05/98--> MASTER D 08/80-->07/98 TRAFIC D 03/80-->03/01 MASTER D 05/89-->03/01 TRAFIC D	75 PS / 55 KW 71 PS / 52 KW 69 PS / 51 KW 75 PS / 55 KW	S8U 780 S8U 782 8140.61.2300 8140.61.240 8140.67.2500 8140.67.2510 8140.67.2550 8140.67.2580		 <b>40147005</b> 77 01 040 180 1,80mm <b>40147006</b> 77 01 040 179 1,70mm <b>ø95,2</b>
2,5 2499	4 CYL ø93 MASTER TD MASTER DT 08/89-->07/98	94 PS / 69 KW 98 PS / 72 KW 116 PS / 85 KW 95 PS / 70 KW	S9U 700 S9U 704 8140.07 8140.27 8140.47 SU9 702 8140.27.2580 S9U 714 S9U 740 8140.27.2500 8140.27.2510		 <b>40138005</b> 77 01 043 277 1,50mm <b>40138006</b> 77 01 043 276 1,40mm <b>ø95</b>
2,7 2664	6 CYL ø88 25 V6 04/84-->08/89 30 02/75-->01/84 30 TS 10/78-->12/83 30 TX	141 PS / 104 KW 131 PS / 96 KW 125 PS / 92 KW 143 PS / 105 KW	Z7V 708 Z7V 709 Z7V 711 112 144 140		 79 10 245 291 1,20mm  79 10 245 585 1,20mm <b>ø90</b> <b>40115005</b>

▲ : İçerikte Bulunmamaktadır...

▲ : Not included in the set

▲ : Non inclus dans la pochette

00: Motor Takım Keçesiz ve Subap Lastiksiz













00: Gasket Set Without oil seals Without Valve Stem Seal

01: Motor Takım Keçesiz - Subap Lastikli

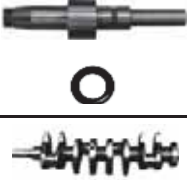
01: Gasket set With Valve Stem Seal Without Oil Seals

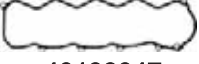
02: Motor Full Takım Keçeli ve Subap Lastikli

02: Gasket Full Set With oil seals and Valve Stem Seals

<p>Subap Kapak Valve Cover Gasket Zylinderkopfhaube Couvre-culbut.</p> 	<p>Karter Oil Pan Ölwanne Carter d'huile</p> 	<p>Emme Manifold Intake Manifold Ansaug Admission</p> 	<p>Egzoz Manifold Exhaust Manifold Auspuffkrümmer Collecteur D'echappement</p> 	<p>Eksoz Boğaz Exhaust Pipe Auspuff Kehle</p> 	<p>Supap Keçesi Valve Stem Seal Ventilschaft Queue de soupape</p> 	
 <p><b>40138045</b> 50 01 846 751</p>  <p><b>40138047</b> 0249.C3</p>	 <p><b>40146066</b> 77 01 043 496</p>  <p><b>40138068</b> 500327440</p>	 <p><b>40146019x4</b> 77 00 034 967</p>	 <p><b>40147021x4</b> 77 01 05 824</p>			

■ : Delik - Çentik

■ : Hole - Notch

■ : Trou - Entaille

NOT: Katalogdaki Orijinal Kodlar Referans Amacıyla Kullanılmıştır.Lütfen Oto Conta Kodlarını Kullanınız.  
Original codes used for reference only.Please use OTO CONTA codes for orders.



RENAULT

00



01



02



03



04



Silindir Kapak  
Cylinder Head  
Zylinderkopf  
Joint de culasse



Ltr MODEL PS/KW ENGINE/MOTOR

2,8 4 CYL ø94,4  
2799 MASTER DTI

07/98-->

114 PS / 84 KW

S9W 700  
S9W 702

40139100  
71713696



**40139005**  
77 01 044 227  
1,50mm

**40139006**  
77 01 044 226  
1,40mm

**40139007**  
77 01 044 225  
1,30mm  
ø96

▲ : İçerikte Bulunmamaktadır...

▲ : Not included in the set

▲ : Non inclus dans la pochette

00: Motor Takım Keçesiz ve Subap Lastiksiz













00: Gasket Set Without oil seals Without Valve Stem Seal

01: Motor Takım Keçesiz - Subap Lastikli

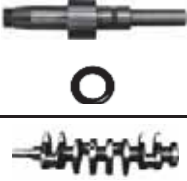
01: Gasket set With Valve Stem Seal Without Oil Seals

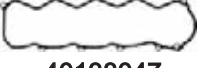
02: Motor Full Takım Keçeli ve Subap Lastikli

02: Gasket Full Set With oil seals and Valve Stem Seals

<p>Subap Kapak Valve Cover Gasket Zylinderkopfhaube Couvre-culbut.</p> 	<p>Karter Oil Pan Ölwanne Carter d'huile</p> 	<p>Emme Manifold Intake Manifold Ansaug Admission</p> 	<p>Egzoz Manifold Exhaust Manifold Auspuffkrümmer Collecteur D'echappement</p> 	<p>Eksoz Boğaz Exhaust Pipe Auspuff Kehle</p> 	<p>Supap Keçesi Valve Stem Seal Ventilschaft Queue de soupape</p> 	
 <p><b>40138045</b> 50 01 846 751</p>  <p><b>40138047</b> 0249.C3</p>	 <p><b>40138068</b> 500327440</p>	 <p><b>40146019x4</b> 77 00 034 967</p>	 <p><b>40147021x4</b> 77 01 035 824</p>			

■ : Delik - Çentik

■ : Hole - Notch

■ : Trou - Entaille

NOT: Katalogdaki Orijinal Kodlar Referans Amacıyla Kullanılmıştır.Lütfen Oto Conta Kodlarını Kullanınız.  
Original codes used for reference only.Please use OTO CONTA codes for orders.



SAVIEM

00



Silindir Kapak

Cylinder Head

01



Zylinderkopf

02



Joint de culasse

03



04



Ltr	MODEL	PS/KW	ENGINE/MOTOR		
2,2 2140	4 CYL 88x88 ESSENCE 671				 <b>40135005</b> 855783800 1,30mm ø88
2,6 2600	4 CYL ø93 / 96 ESSENCE 817				 <b>40145005</b> 5000131017 1,30mm ø96
3,0 3,3 3,6 3017 3319 3595	4 CYL 98 / 102 TRAFIC SG-2M TRAFIC SG-4 TRAFIC SG-5 TRAFIC SG-5SD TRAFIC SG-5C	70 PS / 51 KW 73 PS / 54 KW	599 599 712	<b>60150001</b> 996090400	 <b>40150005</b> 5000044437 1,40mm ø110
3,6 3595	4 CYL ø102 TRAFIC SG-5C T.D	90 PS / 66 KW		<b>60151101</b> 500336300	 <b>40150006</b> 5000044908 2,00mm ø110

▲ : İçerikte Bulunmamaktadır...

▲ : Not included in the set

▲ : Non inclus dans la pochette

00: Motor Takım Keçesiz ve Subap Lastiksiz











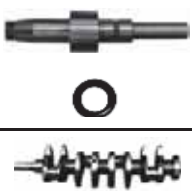







00: Gasket Set Without oil seals Without Valve Stem Seal

01: Motor Takım Keçesiz - Subap Lastikli

01: Gasket set With Valve Stem Seal Without Oil Seals

02: Motor Full Takım Keçeli ve Subap Lastikli

02: Gasket Full Set With oil seals and Valve Stem Seals

Subap Kapak Valve Cover Gasket Zylinderkopfhaube Couvre-culbut.	Karter Oil Pan Ölwanne Carter d'huile	Emme Manifold Intake Manifold Ansaug Admission	Egzoz Manifold Exhaust Manifold Auspuffkrümmer Collecteur D'echappement	Eksoz Boğaz Exhaust Pipe Auspuff Kehle	Supap Keçesi Valve Stem Seal Ventilschaft Queue de soupape	
						
						
<b>40117034</b> 5000041255	<b>40117013</b> 428297200	<b>40117018x4</b> 5000049389	<b>40117020x4</b> 607859100		<b>40139044x8</b> 7301732 8x12x15,2x9,5	
						
<b>40117034</b> 5000041255	<b>40117013</b> 428297200	<b>40117018x4</b> 5000049389	<b>40117020x4</b> 607859100		<b>40139044x8</b> 7301732 8x12x15,2x9,5	

■ : Delik - Çentik

■ : Hole - Notch

■ : Trou - Entaille

NOT: Katalogdaki Orijinal Kodlar Referans Amacıyla Kullanılmıştır.Lütfen Oto Conta Kodlarını Kullanınız.  
Original codes used for reference only.Please use OTO CONTA codes for orders.



SKODA

00



01



02



03



04



Silindir Kapak  
Cylinder Head  
Zylinderkopf  
Joint de culasse



Ltr	MODEL	PS/KW	ENGINE/MOTOR		
1,2 1198	3 CYL ø76,5 FABIA 01/03--> ROOMSTER	70 PS / 51 KW 60 PS / 44 KW	AZQ BME BZG CEVA CGPA CGPB CHTA		 <b>41502005</b> 03E 103 383 F 1,20mm FIBER / FIBRE ø77,5
1,3 1289	4 CYL ø75,5 FAVORIT 115 09/84-->09/94 FAVORIT 136 FELICIA 135 FELICIA 136 FORMAN 136 FAVORIT 135 FORMAN 135 RAPID 130 PICK-UP 781 FAVORIT 781	61 PS / 45 KW 58 PS / 43 KW	135/8 136 L 135 B 136 B AMG AMH OHC	<b>41501001</b> Motor Takım Gasket Set  <b>41501003</b> Üst Takım Gasket Head Set	 <b>41501005</b> 114-092854 1,60mm  <b>461501006</b> 114-092854 2,00mm ø77
1,4 1391	4 CYL ø76,5 FABIA 10/99--> OCTAVIA  OCTAVIA 08/00--> FABIA 06/04--> OCTAVIA ROOMSTER	100 PS / 74 KW 75 PS / 55 KW  75 PS / 55 KW 86 PS / 63 KW 80 PS / 59 KW	AUA AUB AXP BBY BBZ BKY BCA BUD BXW CGGA	<b>41405303</b>	 <b>41405305</b> 036 103 383 AM MLS ø77,5
1,9 1896	4 CYL ø79,5 FELICIA 10/95-->06/01	64 PS / 47 KW	AEY		 <b>41405205</b> 028 103 383 BN 1,61mm 3 ■ <b>41405206</b> 028 103 383 BM 1,53mm 2 ■ <b>41405207</b> 028 103 383 BL 1,45mm 1 ■ MLS ø81

▲ : İçerikte Bulunmamaktadır...

▲ : Not included in the set

▲ : Non inclus dans la pochette

00: Motor Takım Keçesiz ve Subap Lastiksiz











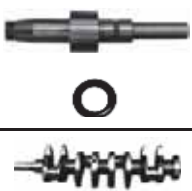



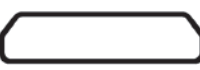

00: Gasket Set Without oil seals Without Valve Stem Seal

01: Motor Takım Keçesiz - Subap Lastikli

01: Gasket set With Valve Stem Seal Without Oil Seals

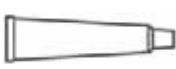
02: Motor Full Takım Keçeli ve Subap Lastikli

02: Gasket Full Set With oil seals and Valve Stem Seals

Subap Kapak Valve Cover Gasket Zylinderkopfhaube Couvre-culbut.	Karter Oil Pan Ölwanne Carter d'huile	Emme Manifold Intake Manifold Ansaug Admission	Egzoz Manifold Exhaust Manifold Auspuffkrümmer Collecteur D'echappement	Eksoz Boğaz Exhaust Pipe Auspuff Kehle	Supap Keçesi Valve Stem Seal Ventilschaft Queue de soupape	
						
 <b>41501025</b> 047 103 483	 <b>41501013</b> 113-090920	 <b>41501020</b> 114-095840	 <b>41501017</b> 115690840	 <b>40107027x8</b> 113-028540 8x10,8x14,2x10		
 <b>42427465</b>	 <b>42427465</b>	 <b>41405319x6</b> 036 129 717 E	 <b>41405321</b> 036 253 039 F		 <b>42457127x16</b> 036 109 675 6x8,8x12,2x9,7	<b>21204029x2</b> 27x42x8 RD

■ : Delik - Çentik

■ : Hole - Notch

■ : Trou - Entaille

NOT: Katalogdaki Orijinal Kodlar Referans Amacıyla Kullanılmıştır.Lütfen Oto Conta Kodlarını Kullanınız.  
Original codes used for reference only.Please use OTO CONTA codes for orders.



TOYOTA

00



Silindir Kapak  
Cylinder Head  
Zylinderkopf  
Joint de culasse

01



02



03



04



Ltr	MODEL	PS/KW	ENGINE/MOTOR		
1,6 1588	4 CYL ø80,5 CORONA HI-LUX HI-ACE TOYO-ACE 02/77-->03/83	67 PS / 49 KW	12R 12R-U/RJ		 <b>41411505</b> 11115-31020 1,80mm <b>41411506</b> 11115-31020 2,0mm ø83
1,8 1812	4 CYL ø86 TOWN-ACE LITE-ACE HI-LUX CORONA DYNA 100 MASTER-ACE 03/83-->11/89	79 PS / 58 KW 83 PS / 61 KW	1Y-J 2Y 2YPU		 <b>41411605</b> 11115-71010 1,80mm <b>41411606</b> 11115-71010 2,0mm ø88
2,0 1998	4 CYL ø86 HI-ACE HI-LUX CROWN CRESSIDA WAGON DYNA 150 01/84-->11/89	88 PS / 65 KW 78 PS / 57 KW	3Y 3Y-PU		 <b>41411605</b> 11115-71010 1,80mm <b>41411606</b> 11115-71010 2,0mm ø88
2,0 1998	4 CYL ø86 HI-LUX 16V INNOVA 16V 04/06-->09/06	133 PS / 98 KW	1TR-FE		 <b>41411805</b> 11115-0C011 1,20mm FIBER / FIBRE <b>41411806</b> 11115-0C011 2,00mm FIBER / FIBRE ø88

▲ : İçerikte Bulunmamaktadır...

▲ : Not included in the set

▲ : Non inclus dans la pochette

00: Motor Takım Keçesiz ve Subap Lastiksiz







00: Gasket Set Without oil seals Without Valve Stem Seal

01: Motor Takım Keçesiz - Subap Lastikli

01: Gasket set With Valve Stem Seal Without Oil Seals

02: Motor Full Takım Keçeli ve Subap Lastikli

02: Gasket Full Set With oil seals and Valve Stem Seals

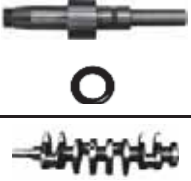
<p>Subap Kapak Valve Cover Gasket Zylinderkopfhaube Couvre-culbut.</p> 	<p>Karter Oil Pan Ölwanne Carter d'huile</p> 	<p>Emme Manifold Intake Manifold Ansaug Admission</p> 	<p>Egzoz Manifold Exhaust Manifold Auspuffkrümmer Collecteur D'echappement</p> 	<p>Eksoz Boğaz Exhaust Pipe Auspuff Kehle</p> 	<p>Supap Keçesi Valve Stem Seal Ventilschaft Queue de soupape</p> 	

■ : Delik - Çentik

■ : Hole - Notch

■ : Trou - Entaille

NOT: Katalogdaki Orijinal Kodlar Referans Amacıyla Kullanılmıştır.Lütfen Oto Conta Kodlarını Kullanınız.  
Original codes used for reference only.Please use OTO CONTA codes for orders.



TOYOTA

00



Silindir Kapak

Cylinder Head

01



Zylinderkopf

02



Joint de culasse

03



04



Ltr	MODEL	PS/KW	ENGINE/MOTOR	
2,2 2237	4 CYL ø91 TOWN-ACE VAN WAGON STOUT VAN HI-LUX LITE-ACE DYNA 200	01/87-->01/95 98 PS / 72 KW 94 PS / 69 KW	4Y 4Y-EC	 <b>41411105</b> 11115-73010 1,60mm <b>41411106</b> 11115-73010 2,00mm ø93
2,7 2694	4 CYL ø95 HI-LUX 16V INNOVA 16V FORTURNER 16V TACOMA 16V HI-ACE 16V	08/04--> 144 PS / 106 KW 151 PS / 111 KW		 <b>41411705</b> 11115-0C020 1,20mm FIBER / FIBRE <b>41411706</b> 11115-0C020 2,00mm FIBER / FIBRE ø97

▲ : İçerikte Bulunmamaktadır...

▲ : Not included in the set

▲ : Non inclus dans la pochette

00: Motor Takım Keçesiz ve Subap Lastiksiz









00: Gasket Set Without oil seals Without Valve Stem Seal

01: Motor Takım Keçesiz - Subap Lastikli

01: Gasket set With Valve Stem Seal Without Oil Seals

02: Motor Full Takım Keçeli ve Subap Lastikli

02: Gasket Full Set With oil seals and Valve Stem Seals

<p>Subap Kapak Valve Cover Gasket Zylinderkopfhaube Couvre-culbut.</p> 	<p>Karter Oil Pan Ölwanne Carter d'huile</p> 	<p>Emme Manifold Intake Manifold Ansaug Admission</p> 	<p>Egzoz Manifold Exhaust Manifold Auspuffkrümmer Collecteur D'echappement</p> 	<p>Eksoz Boğaz Exhaust Pipe Auspuff Kehle</p> 	<p>Supap Keçesi Valve Stem Seal Ventilschaft Queue de soupape</p> 	  

■ : Delik - Çentik

■ : Hole - Notch

■ : Trou - Entaille

NOT: Katalogdaki Orijinal Kodlar Referans Amacıyla Kullanılmıştır.Lütfen Oto Conta Kodlarını Kullanınız.  
Original codes used for reference only.Please use OTO CONTA codes for orders.



VOLVO

00



01



02



03



04



Silindir Kapak  
Cylinder Head  
Zylinderkopf  
Joint de culasse



Ltr MODEL PS/KW ENGINE/MOTOR

Ltr	MODEL	PS/KW	ENGINE/MOTOR		
1,3 1286	4 CYL ø73 66 08/75-->11/79 -->26917	57 PS / 42 KW	B130S B130	▲ 40101001 Motor Takım Gasket Set  40101002 77 01 452 153	 40101005 77 00 576 242 1,20mm  40101009 77 00 576 242 1,80mm ø74,3
1,4 1397	4 CYL ø76 340 343 345 360 08/1975->12/1988	70 PS / 51 KW 63 PS / 46 KW	B 14.3 E B 14.3 S	40102002 3267492-1  ▲ 40102001  3267492-1  40102003 3 267 492-1	 40102005 77 00 680 689 1,20mm  40102006 77 00 680 689 1,40mm  40102009 77 00 680 689 1,80mm ø77
1,6 1596	4 CYL ø79 S40 16V C30 16V 01/05-->	101 PS / 74 KW	B4164S3		 42218205 30 711 613 1,20mm FIBER / FIBRE ø80

▲ : İçerikte Bulunmamaktadır...

▲ : Not included in the set

▲ : Non inclus dans la pochette

00: Motor Takım Keçesiz ve Subap Lastiksiz











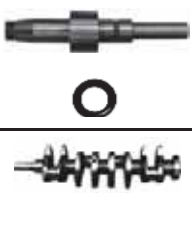

00: Gasket Set Without oil seals Without Valve Stem Seal

01: Motor Takım Keçesiz - Subap Lastikli

01: Gasket set With Valve Stem Seal Without Oil Seals

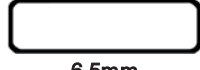
02: Motor Full Takım Keçeli ve Subap Lastikli

02: Gasket Full Set With oil seals and Valve Stem Seals

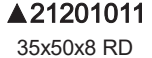
Subap Kapak Valve Cover Gasket Zylinderkopfhaube Couvre-culbut.	Karter Oil Pan Ölwanne Carter d'huile	Emme Manifold Intake Manifold Ansaug Admission	Egzoz Manifold Exhaust Manifold Auspuffkrümmer Collecteur D'echappement	Eksoz Boğaz Exhaust Pipe Auspuff Kehle	Supap Keçesi Valve Stem Seal Ventilschaft Queue de soupape	
 5,00mm <b>4101525</b> 77 00 723 967	 <b>40101265</b> 77 01 453 950	 <b>40101020</b> 77 00 559 702	 <b>40101017</b> 77 00 502 706	 <b>40101017</b> 77 00 502 706	 <b>21201011</b> 35x50x8 RD <b>21201031</b> 70x90x10 LD	 
 6,5mm <b>40102525</b> 77 01 348 574	 <b>40102265</b> 77 01 457 561	 <b>40101020</b> 77 00 559 702	 <b>40101017</b> 77 00 502 706	 <b>40101017</b> 77 00 502 706	 <b>▲21201011</b> 35x50x8 RD <b>▲21201034</b> 80x100x13 LD	

■ : Delik - Çentik

■ : Hole - Notch

■ : Trou - Entaille

NOT: Katalogdaki Orijinal Kodlar Referans Amacıyla Kullanılmıştır.Lütfen Oto Conta Kodlarını Kullanınız.  
Original codes used for reference only.Please use OTO CONTA codes for orders.



VOLVO

00



01



02



03













04



Silindir Kapak  
Cylinder Head  
Zylinderkopf  
Joint de culasse



Ltr MODEL PS/KW ENGINE/MOTOR

Ltr	MODEL	PS/KW	ENGINE/MOTOR		
1,6 1598	4 CYL ø75 C30 D 01/05--> S40 D S80 II D V50 D V70 III D	110 PS / 81 KW 109 PS / 80 KW	D 4164 T	<b>41707002</b> Motor Full Takım Gasket Full Set  <b>41707003</b> Motor Üst Takım Gasket Head Set  <b>41707004</b> Motor Alt Takım Conversion Set	 <b>41707005</b> 30 735 085 1,45mm 5  <b>41707006</b> 30 735 084 1,40mm 4  <b>41707007</b> 30 735 082 1,30mm 3  <b>41707008</b> 30 735 081 1,25mm 2  <b>41707009</b> 30 735 083 1,35mm 1  MLS ø76
1,7 1721	4 CYL ø81 340-360 08/85--> 440 T 460 T 480 T 440 04/86--> 460 480	122 PS / 90 KW 79 PS / 58 KW 109 PS / 80 KW 79 PS / 58 KW	B 17 2 K B 18 FT B 18 FTM B 18 K B 18 E B 18 ED B 18 EP B 18 F B 18 FP B 18 KD B 18 KP B 18 KPD		 <b>40107005</b> 3 344 303-7 1,40mm <b>40107009</b> 3 344 303-7 1,80mm ø82
1,8 1794	4 CYL ø82,2 440 08/91-->12/96 460	90 PS / 66 KW	B 18 U		 <b>40134005</b> 3 467 605 1,20mm <b>40134007</b> 3 467 605 1,60mm ø83,7

▲ : İçerikte Bulunmamaktadır...

▲ : Not included in the set

▲ : Non inclus dans la pochette

00: Motor Takım Keçesiz ve Subap Lastiksiz



















00: Gasket Set Without oil seals Without Valve Stem Seal

01: Motor Takım Keçesiz - Subap Lastikli

01: Gasket set With Valve Stem Seal Without Oil Seals

02: Motor Full Takım Keçeli ve Subap Lastikli

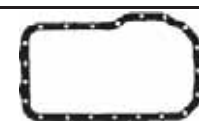
02: Gasket Full Set With oil seals and Valve Stem Seals

Subap Kapak Valve Cover Gasket Zylinderkopfhaube Couvre-culbut.	Karter Oil Pan Ölwanne Carter d'huile	Emme Manifold Intake Manifold Ansaug Admission	Egzoz Manifold Exhaust Manifold Auspuffkrümmer Collecteur D'echappement	Eksoz Boğaz Exhaust Pipe Auspuff Kehle	Supap Keçesi Valve Stem Seal Ventilschaft Queue de soupape	
						
 <b>41707025</b> 30 735 093	 <b>42427465</b>	 30 711 091 x4  30 711 090 x4 <b>41707018</b> 0348.R5+0348.R4 <b>SET</b>	 <b>41706021</b> 30 711 093		 <b>41707026x16</b> 30 711 502 5,5x9,5x18,1x14	<b>21204017</b> 27x47x7 RD <b>21204018</b> 40x55x6,4 LD <b>21204019</b> 85x105x8,8 RD
 <b>40104525</b> 77 00 719 666		 <b>40107021</b> 77 00 725 397				
 <b>40104525</b> 77 00 719 666	 <b>40113265</b> 77 00 859 751	 <b>40134021</b> 77 00 854 539				

■ : Delik - Çentik

■ : Hole - Notch

■ : Trou - Entaille

NOT: Katalogdaki Orijinal Kodlar Referans Amacıyla Kullanılmıştır.Lütfen Oto Conta Kodlarını Kullanınız.  
Original codes used for reference only.Please use OTO CONTA codes for orders.



VOLVO"

00



01



02



03



04



Silindir Kapak  
Cylinder Head  
Zylinderkopf  
Joint de culasse



Ltr	MODEL	PS/KW	ENGINE/MOTOR		
1,9 1870	4 CYL ø80 S40 TD V40 TD 440 TD 460 TD 07/94-->	94 PS / 69 KW 90 PS / 66 KW	D 19 T D 4192 T F8Q 768		 <b>40152005</b> 3 345 350 1,60mm 3 <b>M</b> <b>40152006</b> 3 345 349 1,50mm 1 <b>M</b> <b>40152007</b> 3 345 348 1,40mm 2 <b>M</b> ø81
1,9 1870	4 CYL ø80 S40 DI V40 DI 03/99-->07/00	95 PS / 70 KW	D 4192 T2	<b>40152102</b> Motor Takım Gasket Set  <b>40152103</b> 77 01 470 288  <b>40152104</b> 77 01 470 176	 <b>40152105</b> 30 889 391 1,45mm 1 <b>M</b> <b>40152106</b> 30 889 390 1,35mm 2 <b>M</b> <b>40152107</b> 30 889 392 1,55mm 3 <b>M</b> FIBER / FIBRE ø81
1,9 1870	4 CYL ø80 S40 DI V40 DI 07/00-->06/04	115 PS / 85 KW 102 PS / 75 KW	D 4192 T3 D 4192 T4	<b>40152102</b> Motor Takım Gasket Set  <b>40152103</b> 77 01 470 288  <b>40152104</b> 77 01 470 176	 <b>40152205</b> 31 216 523 1,32mm <b>40152206</b> 82 00 780 116 1,60mm MLS ø81

▲ : İçerikte Bulunmamaktadır...

▲ : Not included in the set

▲ : Non inclus dans la pochette

00: Motor Takım Keçesiz ve Subap Lastiksiz











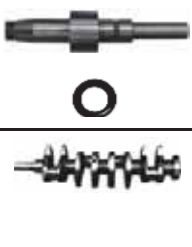





00: Gasket Set Without oil seals Without Valve Stem Seal

01: Motor Takım Keçesiz - Subap Lastikli

01: Gasket set With Valve Stem Seal Without Oil Seals

02: Motor Full Takım Keçeli ve Subap Lastikli

02: Gasket Full Set With oil seals and Valve Stem Seals

Subap Kapak Valve Cover Gasket Zylinderkopfhaube Couvre-culbut.	Karter Oil Pan Ölwanne Carter d'huile	Emme Manifold Intake Manifold Ansaug Admission	Egzoz Manifold Exhaust Manifold Auspuffkrümmer Collecteur D'echappement	Eksoz Boğaz Exhaust Pipe Auspuff Kehle	Supap Keçesi Valve Stem Seal Ventilschaft Queue de soupape	
						
						<b>21204002</b> 25x42x8 RD
<b>40152025</b> 30 621 277	<b>40152065</b> 31 251 147	<b>40152121</b> 30 750 740			<b>40116026x8</b> 3 517 893 7x9,8/13.2x10	<b>21204014</b> 42x54x6 RD
						<b>21208011</b> 85x105x11 LD
						<b>21204002</b> 25x42x8 RD
<b>40152025</b> 30 621 277	<b>40152065</b> 31 251 147	<b>40152121</b> 30 750 740			<b>40116026x8</b> 3 517 893 7x9,8/13.2x10	<b>21204014</b> 42x54x6 RD
						<b>21208011</b> 85x105x11 LD

■ : Delik - Çentik

■ : Hole - Notch

■ : Trou - Entaille

NOT: Katalogdaki Orijinal Kodlar Referans Amacıyla Kullanılmıştır.Lütfen Oto Conta Kodlarını Kullanınız.  
Original codes used for reference only.Please use OTO CONTA codes for orders.



VOLVO

00



Silindir Kapak  
Cylinder Head  
Zylinderkopf  
Joint de culasse

01



02



03



04



Ltr	MODEL	PS/KW	ENGINE/MOTOR	
2,0 1986	4 CYL ø89 240 08/83-->10/98 340-360 740 740 T 940 940 T  240 08/80-->08/90 340 360 740	189 PS / 139 KW 109 PS / 80 KW  105 PS/ 77 KW 95 PS / 70 KW	B 200 E B 200 EA B 200 ET B 200 F B 200 FT B 200 G B 200 GT B 200 K B 200 K B 200 K B 200 K	 <b>41405005</b> 1 378 645-1 1,30mm <b>ø95</b>
2,0 1998	4 CYL ø82,2 440 08/92-->07/96 460 480	110 PS / 81 KW 109 PS / 80 KW	B 20 F	 <b>40134005</b> 3 467 605 1,20mm <b>40134007</b> 3 467 605 1,60mm <b>ø83,7</b>
2,0 1999	4 CYL ø87,5 C30 10/06--> S40 S40 II S80 II V50 V70	146 PS / 107 KW 145 PS / 107 KW	B 4204 S3 B 4204 S4	 <b>41420405</b> 30777325 1,20mm FIBER / FIBRE <b>ø89</b>

▲ : İçerikte Bulunmamaktadır...

▲ : Not included in the set

▲ : Non inclus dans la pochette

00: Motor Takım Keçesiz ve Subap Lastiksiz













00: Gasket Set Without oil seals Without Valve Stem Seal

01: Motor Takım Keçesiz - Subap Lastikli

01: Gasket set With Valve Stem Seal Without Oil Seals

02: Motor Full Takım Keçeli ve Subap Lastikli

02: Gasket Full Set With oil seals and Valve Stem Seals

<p>Subap Kapak Valve Cover Gasket Zylinderkopfhaube Couvre-culbut.</p> 	<p>Karter Oil Pan Ölwanne Carter d'huile</p> 	<p>Emme Manifold Intake Manifold Ansaug Admission</p> 	<p>Egzoz Manifold Exhaust Manifold Auspuffkrümmer Collecteur D'echappement</p> 	<p>Eksoz Boğaz Exhaust Pipe Auspuff Kehle</p> 	<p>Supap Keçesi Valve Stem Seal Ventilschaft Queue de soupape</p> 	  
 <p><b>40104525</b> 77 00 719 666</p>	 <p><b>40113265</b> 77 00 859 751</p>	 <p><b>40134021</b> 77 00 854 539</p>				

■ : Delik - Çentik

■ : Hole - Notch

■ : Trou - Entaille

NOT: Katalogdaki Orijinal Kodlar Referans Amacıyla Kullanılmıştır.Lütfen Oto Conta Kodlarını Kullanınız.  
Original codes used for reference only.Please use OTO CONTA codes for orders.



VOLVO

00



Silindir Kapak  
Cylinder Head  
Zylinderkopf  
Joint de culasse

01



02



03



04



Ltr MODEL PS/KW ENGINE/MOTOR

Ltr	MODEL	PS/KW	ENGINE/MOTOR		
2,0	4 CYL ø89				
1986	240 1977-->	117 PS / 86 KW	B19E	41405000	
	242 1977-->	117 PS / 86 KW	B19E	270676-0	41405005 1 378 645-1 1,30mm ø95
	244 1977-->	117 PS / 86 KW	B19E	270677-8	
	245 1977-->	117 PS / 86 KW	B19E		
	340 08/1982-->07/1984	115 PS / 85 KW	B19E		
	343 08/1982-->07/1984	115 PS / 85 KW	B19E		
	344 08/1982-->07/1984	115 PS / 85 KW	B19E		
	345 08/1982-->07/1984	115 PS / 85 KW	B19E		
	360 1983-->	117 PS / 86 KW	B19E		
	740 1983-->	117 PS / 86 KW	B19E		
	760 1983-->	117 PS / 86 KW	B19E		
	240 1977-->	90 PS / 66 KW	B19A		
	242 1977-->	90 PS / 66 KW	B19A		
	244 1977-->	90 PS / 66 KW	B19A		
	245 1977-->	90 PS / 66 KW	B19A		
	340 08/1983->07/1984	92 PS / 68 KW	B19A		
	343 1977-->	90 PS / 66 KW	B19A		
	344 08/1983->07/1984	92 PS / 68 KW	B19A		
	345 1977-->	90 PS / 66 KW	B19A		
	GLE				
	GLS				
	DLS				
2,1	4 CYL ø92				
2127	240 08/1975->07/1984	107 PS / 79 KW	B21 A	41405000	
	240 08/1980->07/1985	155 PS / 114 KW	B21 ET	270676-0	41405005 1 378 645-1 1,30mm ø95
	240 08/1980->07/1984	107 PS / 79 KW	B21F	270677-8	
	242 08/1980->07/1985	155 PS / 114 KW	B21 ET		
	242 08/1975->07/1984	107 PS / 79 KW	B21 A		
	242 1975---->	136 PS / 100 KW	B21E/F/T		
	242 1975---->	136 PS / 100 KW	B21E/F/T		
	244 1975---->	136 PS / 100 KW	B21E/F/T		
	244 08/1975->07/1984	107 PS / 79 KW	B21 A		
	244 08/1980->07/1985	155 PS / 114 KW	B21 ET		
	245 08/1975->07/1984	107 PS / 79 KW	B21 A		
	245 1975---->	136 PS / 100 KW	B21E/F/T		
	440 08/1993-->09/1995	110 PS / 80 KW	B21E		
	445 08/1993-->09/1995	110 PS / 80 KW	B21E		
	460 08/1993-->09/1995	110 PS / 80 KW	B21E		
	464 08/1993-->09/1995	110 PS / 80 KW	B21E		
	740 1975---->	136 PS / 100 KW	B21E/F/T		
	760 1975---->	136 PS / 100 KW	B21E/F/T		
	GLE				
	240 08/1974-->07/1984	97 PS / 71 KW 107 PS / 79 KW	B21 A		

▲ : İçerikte Bulunmamaktadır...

▲ : Not included in the set

▲ : Non inclus dans la pochette

00: Motor Takım Keçesiz ve Subap Lastiksiz





















00: Gasket Set Without oil seals Without Valve Stem Seal

01: Motor Takım Keçesiz - Subap Lastikli

01: Gasket set With Valve Stem Seal Without Oil Seals

02: Motor Full Takım Keçeli ve Subap Lastikli

02: Gasket Full Set With oil seals and Valve Stem Seals

Subap Kapak Valve Cover Gasket Zylinderkopfhaube Couvre-culbut.	Karter Oil Pan Ölwanne Carter d'huile	Emme Manifold Intake Manifold Ansaug Admission	Egzoz Manifold Exhaust Manifold Auspuffkrümmer Collecteur D'echappement	Eksoz Boğaz Exhaust Pipe Auspuff Kehle	Supap Keçesi Valve Stem Seal Ventilschaft Queue de soupape	
						
 <b>41406034</b> 1378909-4  <b>41406035</b> 463416-8	 <b>41406013</b> 1378864-1	 <b>41406019</b> 1378879-9	 <b>41406020x4</b> 1378217-2	 <b>41406017</b> 1266713-5		
 <b>41406034</b> 1378909-4  <b>41406035</b> 463416-8	 <b>41406013</b> 1378864-1	 <b>41406019</b> 1378879-9	 <b>41406020x4</b> 1378217-2	 <b>41406017</b> 1266713-5		

 : Delik - Çentik

 : Hole - Notch

 : Trou - Entaille

NOT: Katalogdaki Orijinal Kodlar Referans Amacıyla Kullanılmıştır.Lütfen Oto Conta Kodlarını Kullanınız.  
Original codes used for reference only.Please use OTO CONTA codes for orders.



VOLVO

00



01



02



03



04



Silindir Kapak  
Cylinder Head  
Zylinderkopf  
Joint de culasse



Ltr	MODEL	PS/KW	ENGINE/MOTOR			
2,3 2316	<b>4 CYL ø96</b>					
240	08/1978-->12/1988	136 PS / 100 KW	B23E/F/T	<b>41406000</b>		
242	1978-->	136 PS / 100 KW	B23E/F/T	270684-4	<b>41406005</b> 1378646-2 1,50mm ø98	
244	1978-->	136 PS / 100 KW	B23E/F/T	270685-1		
244	08/1978-->12/1988	136 PS / 100 KW	B23E/F/T			
245	1978-->	136 PS / 100 KW	B23E/F/T			
740	1978-->	136 PS / 100 KW	B23E/F/T			
760	1978-->	136 PS / 100 KW	B23E/F/T			
240	08/1980-->07/1984	112 PS / 82 KW	B23A			
242	1981-->	112 PS / 82 KW	B23A			
244	08/1979-->07/1984	112 PS / 82 KW	B23A			
245	08/1980-->07/1984	112 PS / 82 KW	B23A			
740	08/1984-->07/1990	112 PS / 82 KW	B23A			
744	08/1984-->07/1990	114 PS / 84 KW	B23A			
2,3 2316	<b>4 CYL ø96</b>					
240	08/84-->07/86	112 PS / 82 KW	B 230 A			
740		110 PS / 81 KW	B 230 E			
240	08/83-->10/98	190 PS / 140 KW	B 230 ET			
740		113 PS / 83 KW	B 230 F			
740 T			B 230 FB			
760			B 230 FD			
760 T			B 230 FK			
940			B 230 FT			
940 T			B 230 FT+			
			B 230 G			
			B 230 GK			
			B 230 GT			
			B 230 K			
740	08/87-->08/92	159 PS / 117 KW	B 234 F			
940		151 PS / 111 KW	B 234 G			
2,7 2664	<b>6 CYL ø88</b>					
260	08/75-->07/82	125 PS / 92 KW	B 27 A			
240	08/74-->07/82	148 PS / 109 KW	B 27 E			
260		140 PS / 103 KW	B 27 F			
					245 291-0 1,20mm	
					245 585-5 1,20mm ø90	
					<b>40115005</b>	

▲ : İçerikte Bulunmamaktadır...

▲ : Not included in the set

▲ : Non inclus dans la pochette

00: Motor Takım Keçesiz ve Subap Lastiksiz













00: Gasket Set Without oil seals Without Valve Stem Seal

01: Motor Takım Keçesiz - Subap Lastikli

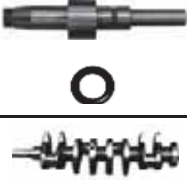
01: Gasket set With Valve Stem Seal Without Oil Seals

02: Motor Full Takım Keçeli ve Subap Lastikli

02: Gasket Full Set With oil seals and Valve Stem Seals

<p>Subap Kapak Valve Cover Gasket Zylinderkopfhaube Couvre-culbut.</p> 	<p>Karter Oil Pan Ölwanne Carter d'huile</p> 	<p>Emme Manifold Intake Manifold Ansaug Admission</p> 	<p>Egzoz Manifold Exhaust Manifold Auspuffkrümmer Collecteur D'echappement</p> 	<p>Eksoz Boğaz Exhaust Pipe Auspuff Kehle</p> 	<p>Supap Keçesi Valve Stem Seal Ventilschaft Queue de soupape</p> 	
 <p><b>41406034</b> 1378909-4</p>  <p><b>41406035</b> 463416-8</p>	 <p><b>41406013</b> 1378864-1</p>	 <p><b>41406019</b> 1378879-9</p>	 <p><b>41406020x4</b> 1378217-2</p>	 <p><b>41406017</b> 1266713-5</p>		

■ : Delik - Çentik

■ : Hole - Notch

■ : Trou - Entaille

NOT: Katalogdaki Orijinal Kodlar Referans Amacıyla Kullanılmıştır.Lütfen Oto Conta Kodlarını Kullanınız.  
Original codes used for reference only.Please use OTO CONTA codes for orders.



# VOLKSWAGEN

00



Silindir Kapak  
Cylinder Head  
Zylinderkopf  
Joint de culasse

01



02



03



04



Ltr	MODEL	PS/KW	ENGINE/MOTOR		
1,0 999	4 CYL ø67 POLO FOX 02/03-->10/03 10/03-->	79 PS / 58 KW 73 PS / 54 KW 65 PS / 48 KW	ARA AQZ AZN BJE BJR BNW BNX BTY CCNA		 <b>41415005</b> 036 103 383 AF 1,20mm FIBER / FIBRE <b>ø68</b>
1,4 1390	4 CYL ø76,5 BORA CADDY GOLF LUPO POLO 08/97-->  GOLF POLO 05/06-->	101 PS / 74 KW 74 PS / 55 KW 80 PS / 59 KW  85 PS / 63 KW 80 PS / 59 KW	AFK AHW AKQ ANM APE AQQ AUA AUB AXP BBY BBZ BCA BCC BKY BUD CGGA CGGB CMAA	<b>41405303</b>	 <b>41405305</b> 036 103 383 AM <b>MLS</b> <b>ø77,5</b>
1,5 1457	4 CYL ø79,5 CADDY GOLF JETTA SCIROCCO 08/77-->02/84	70 PS / 51 KW	GH JB	<b>41401002</b> 049 198 001 C <b>41401003</b> 049 198 012 H <b>41401004</b> 037 198 011 C	 <b>41401005</b> 049 103 383 K 1,60mm <b>ø81</b>

▲ : İçerikte Bulunmamaktadır...

▲ : Not included in the set

▲ : Non inclus dans la pochette

00: Motor Takım Keçesiz ve Subap Lastiksiz











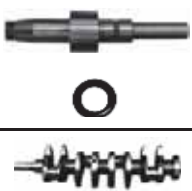







00: Gasket Set Without oil seals Without Valve Stem Seal

01: Motor Takım Keçesiz - Subap Lastikli

01: Gasket set With Valve Stem Seal Without Oil Seals

02: Motor Full Takım Keçeli ve Subap Lastikli

02: Gasket Full Set With oil seals and Valve Stem Seals

Subap Kapak Valve Cover Gasket Zylinderkopfhaube Couvre-culbut.	Karter Oil Pan Ölwanne Carter d'huile	Emme Manifold Intake Manifold Ansaug Admission	Egzoz Manifold Exhaust Manifold Auspuffkrümmer Collecteur D'echappement	Eksoz Boğaz Exhaust Pipe Auspuff Kehle	Supap Keçesi Valve Stem Seal Ventilschaft Queue de soupape	
						
						<b>21204029x2</b> 27x42x8 RD
<b>42427465</b>	<b>42427465</b>	<b>41405319x6</b> 036 129 717 E	<b>41405321</b> 036 253 039 F		<b>42457127x16</b> 036 109 675 <b>6x8,8x12,2x9,7</b>	
						<b>21201075x3</b> 32x47x10 W  <b>21204504</b> 85x105x12 LD
<b>41401034</b> 026 198 025 A	<b>41401013</b> 028 103 609 A	<b>41401019</b> 026 129 717 D	<b>41401021x4</b> 026 129 589 A 056 129 589 B	<b>41401017</b> 841 253 115 B	<b>40107027x8</b> 026 109 675 <b>8x10,8/14,2x10</b>	

■ : Delik - Çentik

■ : Hole - Notch

■ : Trou - Entaille

NOT: Katalogdaki Orijinal Kodlar Referans Amacıyla Kullanılmıştır.Lütfen Oto Conta Kodlarını Kullanınız.  
Original codes used for reference only.Please use OTO CONTA codes for orders.



# VOLKSWAGEN

00



01



02



03



04



Silindir Kapak  
Cylinder Head  
Zylinderkopf  
Joint de culasse



Ltr	MODEL	PS/KW	ENGINE/MOTOR		
1,6 1588	4 CYL ø76,5 GOLF D GOLF TD JETTA D JETTA TD PASSAT D PASSAT TD SANTANA D SANTANA TD TRANSPORTER DASHER D CADDY D	08/80-->07/85 54 PS / 40 KW 70 PS / 51 KW 54 PS / 40 KW 70 PS / 51 KW 54 PS / 40 KW 70 PS / 51 KW 54 PS / 40 KW 70 PS / 51 KW 70 PS / 51 KW 54 PS / 40 KW 54 PS / 40 KW	CR ; JK ; JP ; JR CR ; JK ; JP ; JR CR ; JK ; JP ; JR CR ; JK ; JP ; JR CR ; JK ; CY CR ; JK ; CY CR ; JK ; CY CR ; JK ; CY CS ; JX JF CR ; JK ; JP	<b>41402002</b> Motor Full Takım Gasket Full Set  <b>41402003</b> 068 198 012 L 068 198 012 E 033 198 012 A  <b>41402004</b> 037 198 011 C	 <b>41402005</b> 068 103 383 FN 1,60mm 3 ■ <b>41402006</b> 068 103 383 FM 1,50mm 2 ■ <b>41402007</b> 068 103 383 FL 1,40mm 1 ■ <b>ø78,5</b>
1,6 1588	4 CYL ø76,5 GOLF D GOLF TD JETTA D JETTA TD PASSAT D PASSAT TD SANTANA D SANTANA TD CADDY D TRANSPORTER	08/85-->07/93 70 PS / 51 KW 80 PS / 59 KW 70 PS / 51 KW 80 PS / 59 KW 70 PS / 51 KW 80 PS / 59 KW 70 PS / 51 KW 80 PS / 59 KW 54 PS / 40 KW 70 PS / 51 KW	CR ; ME ; JK ; JP ; 1V CR ; JR ; RA ; SB CR ; ME ; SV ; JK ; JP ; 1V CR ; JK ; JR ; RA ; SB ; SV ; 1V CY ; JK ; JP ; RA ; SB CY ; JK ; JP ; RA ; SB CY ; JK ; JP CY ; JK ; JP CR ; ME ; JK CS ; JX	<b>41402002</b> Motor Full Takım Gasket Full Set  <b>41402003</b> 068 198 012 L 068 198 012 E 033 198 012 A  <b>41402004</b> 037 198 011 C	 <b>41403005</b> 068 103 383 EK 1,61mm 3 ■ <b>41403006</b> 068 103 383 EJ 1,57mm 2 ■ <b>41403007</b> 068 103 383 EH 1,53mm 1 ■ <b>ø78,5</b>
1,6 1595	4 CYL ø81 CADDY GOLF JETTA PASSAT SCIROCCO	01/83-->07/92 75 PS / 55 KW 70 PS / 51 KW	EW EWA EZ EZA HM HN PN RE RF 1F	<b>41408002</b> Motor Full Takım Gasket Full Set  <b>41408003</b> 027 198 012 L  <b>41402004</b> 037 198 011 C	 <b>41408005</b> 026 103 383 P 026 103 383 L 026 103 383 M 026 103 383 N 026 103 383 K 1,75mm <b>ø83</b>

▲ : İçerikte Bulunmamaktadır...

▲ : Not included in the set

▲ : Non inclus dans la pochette

00: Motor Takım Keçesiz ve Subap Lastiksiz





























00: Gasket Set Without oil seals Without Valve Stem Seal

01: Motor Takım Keçesiz - Subap Lastikli

01: Gasket set With Valve Stem Seal Without Oil Seals

02: Motor Full Takım Keçeli ve Subap Lastikli

02: Gasket Full Set With oil seals and Valve Stem Seals

Subap Kapak Valve Cover Gasket Zylinderkopfhaube Couvre-culbut.	Karter Oil Pan Ölwanne Carter d'huile	Emme Manifold Intake Manifold Ansaug Admission	Egzoz Manifold Exhaust Manifold Auspuffkrümmer Collecteur D'echappement	Eksoz Boğaz Exhaust Pipe Auspuff Kehle	Supap Keçesi Valve Stem Seal Ventilschaft Queue de soupape	
						
 <b>41401034</b> 026 103 483 026 103 483 B 026 103 483 C 056 103 483 D	 <b>41401013</b> 028 103 609 A 034 129 717 C	 <b>41401019</b> 026 129 717D  <b>41402019</b> 068 129 717 E	 <b>41401021x4</b> 026 129 589 A 028 129 589 B	 <b>41401017</b> 841 253 115 B	 <b>40107027x8</b> 026 109 675 <b>8x10,8/14,2x10</b>	<b>21201075x3</b> 32x47x10 WD  <b>21204504</b> 85x105x12 LD
 <b>41401034</b> 026 103 483 026 103 483 B 026 103 483 C 056 103 483 D	 <b>41401013</b> 028 103 609 A 034 129 717 C	 <b>41401019</b> 026 129 717D  <b>41402019</b> 068 129 717 E	 <b>41401021x4</b> 026 129 589 A 028 129 589 B	 <b>41401017</b> 841 253 115 B	 <b>40107027x8</b> 026 109 675 <b>8x10,8/14,2x10</b>	<b>21201075x3</b> 32x47x10 WD  <b>21204504</b> 85x105x12 LD
 <b>41401034</b> 026 103 483 026 103 483 B 026 103 483 C 056 103 483 D	 <b>41401013</b> 028 103 609 A 034 129 717 C	 <b>41401019</b> 026 129 717D	 <b>41401021x4</b> 026 129 589 A 028 129 589 B	 <b>41401017</b> 841 253 115 B	 <b>40107027x8</b> 026 109 675 <b>8x10,8/14,2x10</b>	<b>21201075x3</b> 32x47x10 WD  <b>21204504</b> 85x105x12 LD

 : Delik - Çentik

 : Hole - Notch

 : Trou - Entaille

NOT: Katalogdaki Orijinal Kodlar Referans Amacıyla Kullanılmıştır.Lütfen Oto Conta Kodlarını Kullanınız.  
Original codes used for reference only.Please use OTO CONTA codes for orders.



# VOLKSWAGEN

00



Silindir Kapak  
Cylinder Head  
Zylinderkopf  
Joint de culasse

01



02



03



04



Ltr	MODEL	PS/KW	ENGINE/MOTOR		
1,6 1588	4 CYL ø79,5 GOLF GTI 06/76--> PASSAT SCIROCCO CADDY 08/75-->03/88 GOLF JETTA PASSAT SANTANA SCIROCCO  PASSAT 08/75--> SCIROCCO	110 PS / 81 KW 81 PS / 60 KW  85 PS / 63 KW 75 PS / 55 KW  85 PS / 63 KW 65 PS / 48 KW	EG YH YS EM FP FR WV WY YN YP FN FR FT FV WP YN YP YY	41401002 049 198 001 C  41401003 049 198 012 H  41401004 037 198 011 C	 41401005 049 103 383 K 1,60mm ø81
1,6 1598	4 CYL ø76,5 GOLF 09/92-->09/98 VENTO	75 PS / 55 KW	ABU		 41400305 032 103 383 G 032 103 383 H 1,60mm ø77,5
1,7 1716	4 CYL ø79,5 TRANSPORTER 08/85-->07/92	57 PS / 42 KW	KY	41402002 Motor Full Takım Gasket Full Set  41402003 068 198 012 L 068 198 012 E 033 198 012 A  41402004 037 198 011 C	 41404005 033 103 383 M 1,61mm 3 41404006 033 103 383 L 1,57mm 2 41404007 033 103 383 K 1,53mm 1 ø81

▲ : İçerikte Bulunmamaktadır...

▲ : Not included in the set

▲ : Non inclus dans la pochette

00: Motor Takım Keçesiz ve Subap Lastiksiz











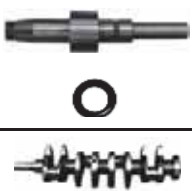









00: Gasket Set Without oil seals Without Valve Stem Seal

01: Motor Takım Keçesiz - Subap Lastikli

01: Gasket set With Valve Stem Seal Without Oil Seals

02: Motor Full Takım Keçeli ve Subap Lastikli

02: Gasket Full Set With oil seals and Valve Stem Seals

Subap Kapak Valve Cover Gasket Zylinderkopfhaube Couvre-culbut.	Karter Oil Pan Ölwanne Carter d'huile	Emme Manifold Intake Manifold Ansaug Admission	Egzoz Manifold Exhaust Manifold Auspuffkrümmer Collecteur D'echappement	Eksoz Boğaz Exhaust Pipe Auspuff Kehle	Supap Keçesi Valve Stem Seal Ventilschaft Queue de soupape	
						
 4 026 198 025 A	 41401013 028 103 609 A	 41401019 026 129 717 D	 41401021x4 026 129 589 A 056 129 589 B	 41401017 841 253 115 B	 40107027x8 026 109 675 8x10,8/14,2x10	21201075x3 32x47x10 W  21204504 85x105x12 LD
 41401034 026 103 483 026 103 483 B 026 103 483 C 056 103 483 D	 41401013 028 103 609 A 034 129 717 C	 41402019 068 129 717 E  41401019 026 129 717D	 41401021x4 026 129 589 A 028 129 589 B	 41401017 841 253 115 B	 40107027x8 026 109 675 8x10,8/14,2x10	21201075x3 32x47x10 WD  21204504 85x105x12 LD

■ : Delik - Çentik

■ : Hole - Notch

■ : Trou - Entaille

NOT: Katalogdaki Orijinal Kodlar Referans Amacıyla Kullanılmıştır.Lütfen Oto Conta Kodlarını Kullanınız.  
Original codes used for reference only.Please use OTO CONTA codes for orders.



# VOLKSWAGEN

00



Silindir Kapak  
Cylinder Head  
Zylinderkopf  
Joint de culasse

01



02



03



04



Ltr	MODEL	PS/KW	ENGINE/MOTOR		
1,7 1716	<b>4 CYL ø79,5</b> CADDY SDI 07/96-->09/00 POLO SDI 04/97-->10/99 LUPO SDI 08/97-->07/05 POLO SDI 08/97-->07/05 POLO SDI 07/97-->09/01	57 PS / 42 KW 57 PS / 42 KW 60 PS / 44 KW 60 PS / 44 KW 60 PS / 44 KW	AHB AHG AKU AKU AKW		 <b>41405205</b> 028 103 383 BR 028 103 383 BN 1,61mm 3 ■ <b>41405206</b> 028 103 383 BQ 028 103 383 BM 1,53mm 2 ■ <b>41405207</b> 028 103 383 BP 028 103 383 BL 1,45mm 1 ■ <b>MLS</b> <b>ø81</b>
1,8 1812	<b>4 CYL ø86</b> TARO 05/89-->09/94	83 PS / 61 KW	2Y		 <b>41411605</b> 11115-71010 1,80mm <b>41411606</b> 11115-71010 2,0mm <b>ø88</b>
1,8 1781	<b>4 CYL ø81</b> CADDY 08/82-->07/93 GOLF GOLF GTI JETTA PASSAT SCIROCCO SCIROCCO GTI	112 PS / 82 KW 84 PS / 62 KW 90 PS / 66 KW 98 PS / 72 KW	EV EX GU GX GZ HT HV JH KT RD RG RH RP RV 1P PB PF 2H	<b>41408002</b> Motor Full Takım Gasket Full Set <b>41408003</b> 027 198 012 L <b>41402004</b> 037 198 011 C	 <b>41408005</b> 026 103 383 P 026 103 383 L 026 103 383 M 026 103 383 N 026 103 383 K 1,75mm <b>ø83</b>

00: Motor Takım Keçesiz ve Subap Lastiksiz













01: Motor Takım Keçesiz - Subap Lastikli

02: Motor Full Takım Keçeli ve Subap Lastikli

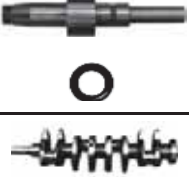
00: Gasket Set Without oil seals Without Valve Stem Seal

01: Gasket set With Valve Stem Seal Without Oil Seals

02: Gasket Full Set With oil seals and Valve Stem Seals

<p>Subap Kapak Valve Cover Gasket Zylinderkopfhaube Couvre-culbut.</p> 	<p>Karter Oil Pan Ölwanne Carter d'huile</p> 	<p>Emme Manifold Intake Manifold Ansaug Admission</p> 	<p>Egzoz Manifold Exhaust Manifold Auspuffkrümmer Collecteur D'echappement</p> 	<p>Eksoz Boğaz Exhaust Pipe Auspuff Kehle</p> 	<p>Supap Keçesi Valve Stem Seal Ventilschaft Queue de soupape</p> 	
 <p><b>41401034</b> 026 103 483 026 103 483 B 026 103 483 C 056 103 483 D</p>	 <p><b>41401013</b> 028 103 609 A 034 129 717 C</p>	 <p><b>41401019</b> 026 129 717D</p>	 <p><b>41401021x4</b> 026 129 589 A 028 129 589 B</p>	 <p><b>41401017</b> 841 253 115 B</p>	 <p><b>40107027x8</b> 026 109 675 <b>8x10,8/14,2x10</b></p>	<p><b>21201075x3</b> 32x47x10 WD</p> <p><b>21204504</b> 85x105x12 LD</p>

■ : Delik - Çentik

■ : Hole - Notch

■ : Trou - Entaille

NOT: Katalogdaki Orijinal Kodlar Referans Amacıyla Kullanılmıştır.Lütfen Oto Conta Kodlarını Kullanınız.  
Original codes used for reference only.Please use OTO CONTA codes for orders.



# VOLKSWAGEN

00



01



02



03



04



Silindir Kapak  
Cylinder Head  
Zylinderkopf  
Joint de culasse



Ltr	MODEL	PS/KW	ENGINE/MOTOR		
1,8 1781	4 CYL ø81 SCIROCCO 16V 09/85-->10/91 JETTA 16V PASSAT 16V CORRADO 16V GOLF 16V PASSAT 08/91-->02/99 GOLF VENTO JETTA GOLF	136 PS / 100 KW 129 PS / 95 KW 90 PS / 66 KW 75 PS / 55 KW	KR JH PL 2H AAM ABS ADZ ADD		 <b>41408005</b> 026 103 383 P 026 103 383 L 026 103 383 M 026 103 383 N 026 103 383 K 1,75mm ø83
1,9 1896	4 CYL ø79,5 GOLF TD 03/91-->04/99 PASSAT TD VENTO TD -->AAZ 462 614 TRANSPORTER 07/90-->04/03 -->1X 104 630 CADDY D 05/89-->01/04 GOLF D PASSAT D POLO D VENTO D -->1Y 315 599	75 PS / 55 KW 61 PS / 45 KW 60 PS / 44 KW 68 PS / 50 KW 64 PS / 47 KW	AAZ 1X 1Y	<b>41405102</b> Motor Full Takım Gasket Full Set  <b>41405103</b> 028 198 012 B  <b>41405104</b> 028 198 011 D	 <b>41405105</b> 028 103 383 BD 1,70mm 3 ■ <b>41405106</b> 028 103 383 BC 1,65mm 2 ■ <b>41405107</b> 028 103 383 BB 1,60mm 1 ■ ø81
1,9 1896	4 CYL ø79,5 GOLF TDI 03/96-->06/02 PASSAT TDI POLO TDI SHARAN TDI VENTO TDI -->AFN 002 000 CADDY TDI 09/93-->03/10 GOLF TDI PASSAT TDI POLO TDI SHARAN TDI VENTO TDI CADDY TDI 09/93-03/10 GOLF TDI PASSAT TDI SHARAN TDI VENTO TDI -->1Z 770 000	110 PS / 81 KW 115 PS / 85 KW 90 PS / 66 KW	AFN AHU 1Z	<b>41405202</b> Motor Full Takım Gasket Full Set  <b>41405203</b> 028 198 012 C  <b>41405104</b> 028 198 011 D	 <b>41405205</b> 028 103 383 BR 028 103 383 BN 1,61mm 3 ■ <b>41405206</b> 028 103 383 BQ 028 103 383 BM 1,53mm 2 ■ <b>41405207</b> 028 103 383 BP 028 103 383 BL 1,45mm 1 ■ MLS ø81

▲ : İçerikte Bulunmamaktadır...

▲ : Not included in the set

▲ : Non inclus dans la pochette

00: Motor Takım Keçesiz ve Subap Lastiksiz











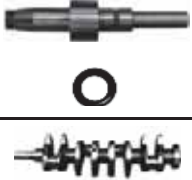





00: Gasket Set Without oil seals Without Valve Stem Seal

01: Motor Takım Keçesiz - Subap Lastikli

01: Gasket set With Valve Stem Seal Without Oil Seals

02: Motor Full Takım Keçeli ve Subap Lastikli

02: Gasket Full Set With oil seals and Valve Stem Seals

Subap Kapak Valve Cover Gasket Zylinderkopfhaube Couvre-culbut.	Karter Oil Pan Ölwanne Carter d'huile	Emme Manifold Intake Manifold Ansaug Admission	Egzoz Manifold Exhaust Manifold Auspuffkrümmer Collecteur D'echappement	Eksoz Boğaz Exhaust Pipe Auspuff Kehle	Supap Keçesi Valve Stem Seal Ventilschaft Queue de soupape	
						
						<b>21208042</b> 32x47x10 WD
<b>41405125</b> 028 103 483 F 028 103 483 H		<b>41405121</b> 028 129 717 D	<b>41401021x4</b> 026 129 589 A 028 129 589 B		<b>40107027x8</b> 026 109 675 <b>8x10,8/14,2x10</b>	<b>21204504</b> 85x105x12 LD
						<b>21208042x2</b> 32x47x10 WD
						<b>21208042</b> 32x47x10 WD
<b>41405225</b> 028 103 483 C 028 103 483 G		<b>41405121</b> 028 129 717 D	<b>41401021x4</b> 026 129 589 A 028 129 589 B		<b>40107027x8</b> 026 109 675 <b>8x10,8/14,2x10</b>	<b>21204504</b> 85x105x12 LD
						<b>21208042x2</b> 32x47x10 WD

■ : Delik - Çentik

■ : Hole - Notch

■ : Trou - Entaille

NOT: Katalogdaki Orijinal Kodlar Referans Amacıyla Kullanılmıştır.Lütfen Oto Conta Kodlarını Kullanınız.  
Original codes used for reference only.Please use OTO CONTA codes for orders.



# VOLKSWAGEN

00



Silindir Kapak  
Cylinder Head  
Zylinderkopf  
Joint de culasse

01



02



03



04



Ltr MODEL PS/KW ENGINE/MOTOR

Ltr	MODEL	PS/KW	ENGINE/MOTOR	
1,9 1986	<b>4 CYL ø79,5</b> CADDY SDI 07/95-->01/04 GOLF SDI 07/95-->01/04 POLO SDI 07/95-->01/04 VENTO SDI 07/95-->01/04 POLO SDI 07/96-->09/01 GOLF TDI 09/96-->06/02 PASSAT TDI 09/96-->06/02 SHARAN TDI 09/96-->06/02 CADDY TDI 09/93-->01/04 GOLF TDI 09/93-->01/04 POLO TDI 09/93-->01/04 VENTO TDI 09/93-->01/04 POLO SDI 10/99-->09/01	64 PS / 47 KW 64 PS / 47 KW 64 PS / 47 KW 64 PS / 47 KW 64 PS / 47 KW 110 PS / 81 KW 90 PS / 66 KW 90 PS / 66 KW 90 PS / 66 KW 90 PS / 66 KW 90 PS / 66 KW 90 PS / 66 KW 64 PS / 47 KW	AEY AEY AEY AEY AGD AHH AVG AVG ALE ALE ALE ALE ASX	 <b>41405205</b> 028 103 383 BR 028 103 383 BN 1,61mm 3 ■ <b>41405206</b> 028 103 383 BQ 028 103 383 BM 1,53mm 2 ■ <b>41405207</b> 028 103 383 BP 028 103 383 BL 1,45mm 1 ■ MLS ø81
2,0 1984	<b>4 CYL ø82,5</b> GOLF GTI 08/92-02/00 PASSAT SHARAN ...->ABF 031 251 GOLF 02/90-04/99 PASSAT VENTO CORRADO 08/88-12/95 PASSAT	150 PS / 110 KW 115 PS / 85 KW 136 PS / 100 KW	ABF 2E 9A	 <b>41408105</b> 048 103 383 B 1,75mm ø83,5
2,2 2237	<b>4 CYL ø91</b> TARO 06/89-->07/94	94 PS / 69 KW	4Y	 <b>41411105</b> 11115-73010 1,60mm <b>41411106</b> 11115-73010 2,00mm ø93

▲ : İçerikte Bulunmamaktadır...

▲ : Not included in the set

▲ : Non inclus dans la pochette

00: Motor Takım Keçesiz ve Subap Lastiksiz







00: Gasket Set Without oil seals Without Valve Stem Seal

01: Motor Takım Keçesiz - Subap Lastikli

01: Gasket set With Valve Stem Seal Without Oil Seals

02: Motor Full Takım Keçeli ve Subap Lastikli

02: Gasket Full Set With oil seals and Valve Stem Seals

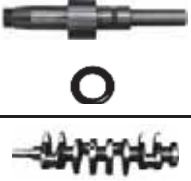
<p>Subap Kapak Valve Cover Gasket Zylinderkopfhaube Couvre-culbut.</p> 	<p>Karter Oil Pan Ölwanne Carter d'huile</p> 	<p>Emme Manifold Intake Manifold Ansaug Admission</p> 	<p>Egzoz Manifold Exhaust Manifold Auspuffkrümmer Collecteur D'echappement</p> 	<p>Eksoz Boğaz Exhaust Pipe Auspuff Kehle</p> 	<p>Supap Keçesi Valve Stem Seal Ventilschaft Queue de soupape</p> 	

■ : Delik - Çentik

■ : Hole - Notch

■ : Trou - Entaille

NOT: Katalogdaki Orijinal Kodlar Referans Amacıyla Kullanılmıştır.Lütfen Oto Conta Kodlarını Kullanınız.  
Original codes used for reference only.Please use OTO CONTA codes for orders.



# VOLKSWAGEN

00



Silindir Kapak

Cylinder Head

01



Zylinderkopf

Joint de culasse

02



03



04



Ltr	MODEL	PS/KW	ENGINE/MOTOR		
2,4					
2370	TRANSPORTER 07/90-->09/98 B70 R 160 001-->	78 PS / 57 KW	AAB		
	TRANSPORTER 08/97-->04/03	75 PS / 55 KW	AJA		
2,5					
2461	TRANSPORTER 09/95-->04/03 LT SDI 07/96-->07/06 LT TDI 05/96-->08/99	102 PS / 75 KW 75 PS / 55 KW 102 PS / 75 KW	ACV AGX AHD		
				<b>42403002</b> 074 198 012 A	

▲ : İçerikte Bulunmamaktadır...

▲ : Not included in the set

▲ : Non inclus dans la pochette

00: Motor Takım Keçesiz ve Subap Lastiksiz













00: Gasket Set Without oil seals Without Valve Stem Seal

01: Motor Takım Keçesiz - Subap Lastikli

01: Gasket set With Valve Stem Seal Without Oil Seals

02: Motor Full Takım Keçeli ve Subap Lastikli

02: Gasket Full Set With oil seals and Valve Stem Seals

Subap Kapak Valve Cover Gasket Zylinderkopfhaube Couvre-culbut.	Karter Oil Pan Ölwanne Carter d'huile	Emme Manifold Intake Manifold Ansaug Admission	Egzoz Manifold Exhaust Manifold Auspuffkrümmer Collecteur D'echappement	Eksoz Boğaz Exhaust Pipe Auspuff Kehle	Supap Keçesi Valve Stem Seal Ventilschaft Queue de soupape	
						
	 <b>42403013</b> 074 103 609 F	 <b>42403019</b> 074 129 717	 <b>42403021x5</b> 026 129 589 A 028 129 589 B		 <b>40107127x10</b> 026 109 675 <b>8x10,8x14,2x10</b>	<b>21208042x2</b> 32x47x10 WD  <b>21208026</b> 35x48x10 RD  <b>21204504</b> 85x105x11 LD

■ : Delik - Çentik

■ : Hole - Notch

■ : Trou - Entaille

NOT: Katalogdaki Orijinal Kodlar Referans Amacıyla Kullanılmıştır.Lütfen Oto Conta Kodlarını Kullanınız.  
Original codes used for reference only.Please use OTO CONTA codes for orders.



# VOLGA

00



Silindir Kapak

Cylinder Head

01



Zylinderkopf

02



Joint de culasse

03



04



Ltr	MODEL	PS/KW	ENGINE/MOTOR		
	4 CYL GAZ 24				 <b>44020005</b> 24-100 30 20 ø92
	4 CYL GAZ 24				 <b>44022005</b> ø100 Elipse
	4 CYL GAZ 2401-2405				 <b>44004005</b> 402 1000 3020 ø93 Elipse
	4 CYL GAZ 2217 - 2705 -2752 - 3110 3221 -3302				 <b>40004605</b> 406 - 100 30 20 ø97,5
	4 CYL GAZ 406				 <b>40004705</b> ø97,5 Elipse
	4 CYL MEMZ - 245 / 2451 / 2457				 <b>44015005</b> 1,40mm

▲ : İçerikte Bulunmamaktadır...

▲ : Not included in the set

▲ : Non inclus dans la pochette

00: Motor Takım Keçesiz ve Subap Lastiksiz

00: Gasket Set Without oil seals Without Valve Stem Seal

01: Motor Takım Keçesiz - Subap Lastikli

01: Gasket set With Valve Stem Seal Without Oil Seals

02: Motor Full Takım Keçeli ve Subap Lastikli

02: Gasket Full Set With oil seals and Valve Stem Seals





IKCO

00



Silindir Kapak  
Cylinder Head

01



Zylinderkopf

02



Joint de culasse

03



04



Ltr	MODEL	PS/KW	ENGINE/MOTOR		
1,6 1587	4 CYL ø78,5 207i PARS 206SD RUNNA SAMAND SOREN	H1-H2 LX V1-V2-V10-V8-V9 LX - SE ELX	TU5JP		 42200005 0209.1E MLS ø79,5
1,8 1761	4 CYL ø83 SAMAND SARIR SOREN	LX - SE ELX	XU7	41233002 0197.G4+0209.E1	 41207005 0209.E1 1,30mm 1 41207006 0209.L8 1,50mm 2  42130005 0209.L3 1,50mm ø84,5
1,7 1645	4 CYL DENA SAMAND SOREN	NA-ELX-TC LX ELX	EF7		 42210005 0,50mm ø80

▲ : İçerikte Bulunmamaktadır...

▲ : Not included in the set

▲ : Non inclus dans la pochette

00: Motor Takım Keçesiz ve Subap Lastiksiz











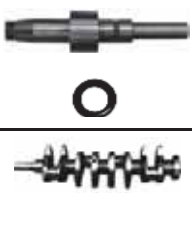





00: Gasket Set Without oil seals Without Valve Stem Seal

01: Motor Takım Keçesiz - Subap Lastikli

01: Gasket set With Valve Stem Seal Without Oil Seals

02: Motor Full Takım Keçeli ve Subap Lastikli

02: Gasket Full Set With oil seals and Valve Stem Seals

Subap Kapak Valve Cover Gasket Zylinderkopfhaube Couvre-culbut.	Karter Oil Pan Ölwanne Carter d'huile	Emme Manifold Intake Manifold Ansaug Admission	Egzoz Manifold Exhaust Manifold Auspuffkrümmer Collecteur D'echappement	Eksoz Boğaz Exhaust Pipe Auspuff Kehle	Supap Keçesi Valve Stem Seal Ventilschaft Queue de soupape	
						
 <b>41233025</b> 0249.71	 <b>41203013</b> 0304.34 93502226.	 <b>41233018x4</b> 0348.E6 + 0348F6	 <b>41233020x4</b> 1723.63		 <b>40107027x8</b> 0956.22 <b>8x10,8/14,2x10</b>	<b>21201062</b> 36x50x7 RD
						<b>21201019</b> 42x62x8 RD
						<b>21201040</b> 90x110x10 LD
 <b>42210025</b>		 <b>42210019</b>	 <b>42210021</b>			

■ : Delik - Çentik

■ : Hole - Notch

■ : Trou - Entaille

NOT: Katalogdaki Orijinal Kodlar Referans Amacıyla Kullanılmıştır.Lütfen Oto Conta Kodlarını Kullanınız.  
Original codes used for reference only.Please use OTO CONTA codes for orders.